

# LIEBHERR

## Use and Care Manual

for beverage center

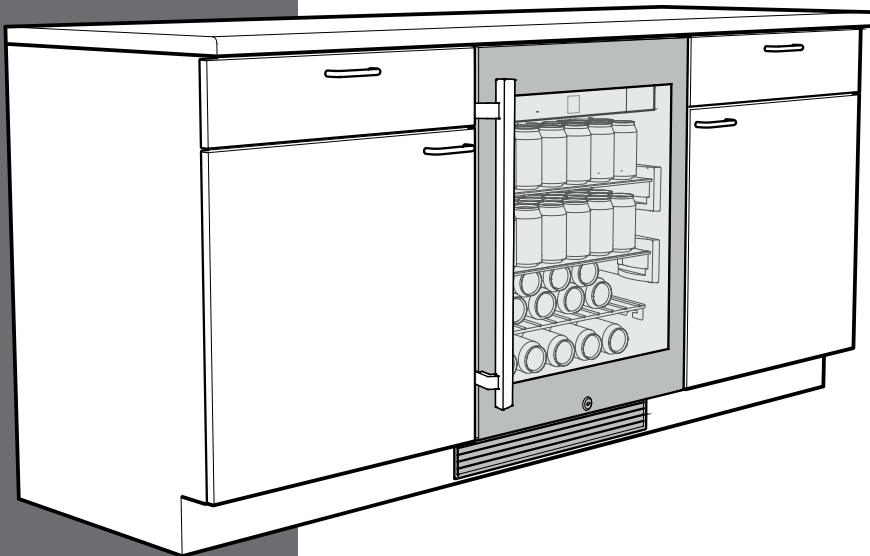

RU 510  
7080 062-02

# TABLE OF CONTENTS

---

Contents	Page
Please Read and Follow these Instructions .....	2
California Proposition 65.....	2
Disposal of Old Appliance .....	3
Disposal of this Appliance .....	3
R600a Refrigerant.....	3
Important Safety Information .....	4
Electrical Safety .....	4
Safety Regulations.....	5
Disposal of Carton .....	5
Setting Up .....	5
Description of the Appliance.....	6
Operating and Control Elements .....	6
Switching the appliance On and Off.....	7
Setting the Temperature .....	7
Ventilation Button.....	7
Door Open Alarm .....	7
Temperature Alarm .....	7
Setup Mode.....	8
Interior Light .....	10
Safety Lock .....	10
Additional Features .....	11
Cleaning .....	12
Customer Service .....	13
Appliance Information .....	13
Turning Off the Appliance .....	13

## IMPORTANT

All types and models are subject to continuous improvement. The manufacturer reserves the right to make modifications in the shape, equipment and technology.

## Please Read and Follow these Instructions

These instructions contain Danger, Warning and Caution notes.

This information is important for safe and efficient installation and operation.

Always read and comply with all Danger, Warning and Caution notes!



### DANGER!

**Danger indicates a hazard which will cause serious injury or death if precautions are not followed.**



### WARNING!

**Warning indicates a potentially hazardous situation which, if not avoided, could result in death or serious injury.**



### CAUTION!

**Caution indicates a potentially hazardous situation which, if not avoided, may result in minor or moderate injury.**

## IMPORTANT

This indicates information that is especially relevant to a problem-free installation and operation.

## California Proposition 65

- This product contains chemicals known to the state of California to cause cancer or reproductive harm.
- This product can expose you to chemicals including Diisononyl Phthalate (DINP) which is known to the State of California to cause cancer. For more information go to [www.P65Warnings.ca.gov](http://www.P65Warnings.ca.gov).
- This product can expose you to chemicals including Di-isodecyl Phthalate (DIDP) which is known to the State of California to cause birth defects or other reproductive harm. For more information go to [www.P65Warnings.ca.gov](http://www.P65Warnings.ca.gov).

## Disposal of Old Appliance



**DANGER!**

### Risk of child entrapment.

Child entrapment and suffocation are not problems of the past.

Junked or abandoned refrigerators are still dangerous – even if they will sit for “just a few days.”

If you are getting rid of your old refrigerator, please follow these instructions to help prevent accidents.

### Before you discard old appliances:

- Take off the doors.
- Leave the shelves in place so that children may not easily climb inside.
- Cut off the power cable from the discarded appliance. Discard separately from the appliance.
- Be sure to follow your local requirements for disposal of appliances.

Contact the trash collection agency in your area for additional information.

## Disposal of this Appliance

This appliance contains flammable gases within the refrigeration circuit and insulation foam.

Contact the municipality or disposal company in your area for information on approved recycling or disposal.

## R600a Refrigerant



**WARNING!**

The refrigerant R600a contained within the appliance is environmentally friendly, but flammable. Leaking refrigerant can ignite.

To prevent possible ignition, follow the warnings below:

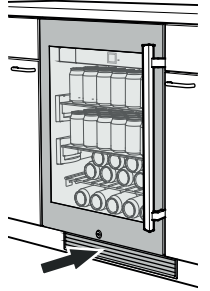
- Keep ventilation openings, in the appliance enclosure or in the built-in structure, clear of obstruction. 
- Do not use mechanical devices or other means to accelerate the defrosting process, other than those recommended by the manufacturer.
- Do not damage the refrigerant circuit.
- Component parts shall be replaced with like components performed by factory authorized service personnel only.
- Do not use electrical appliances inside the refrigerator compartment, unless they are of the type recommended by the manufacturer.

# SAFETY

## Important Safety Information

- To prevent injury to you or damage to the unit, the appliance should be unpacked and set up by two people.
- If the appliance is damaged on delivery, contact the supplier immediately before connecting it to the power source.
- To guarantee safe operation, ensure that the appliance is set up and connected as described in this manual.
- Disconnect the appliance from the power source if a fault occurs. Pull out the plug, turn off or disable the power source.
- When disconnecting the appliance, always pull it out by the plug; never pull on the cable.
- Any repairs and work on the appliance should only be performed by the customer service department. Unauthorized work may be dangerous to the user. The power source cable should only be changed or replaced by the customer service department.
- Do not store explosives or sprays using combustible propellants such as butane, propane, pentane, etc. in the appliance. Electrical components might cause leaking gas to ignite. You can identify such sprays by the printed contents or a flame symbol.
- To prevent possible injury due to an electrical shock, be sure to disconnect the power cord or turn off the circuit breaker before cleaning the appliance.
- To avoid injury or damage to the appliance, do not use steam cleaning equipment to clean the appliance.
- Do not operate the appliance in the presence of explosive fumes.
- In the event of a power outage, open the door as infrequently as possible.
- To protect the appliance from possible damage, allow it to stand 1/2 to 1 hour in place before turning on the electricity. This allows the refrigerant and system lubrication to reach equilibrium.

## Electrical Safety

Connect this appliance to a 15 amp or 20 amp, 110-120 VAC, circuit which is grounded and protected by a circuit breaker or fuse.

We recommend using a dedicated circuit for this appliance to prevent circuit overload and the chance of interruption to the appliance.

This appliance is equipped with a three-prong (grounding) polarized plug for your protection against possible shock hazards.

Where a two-prong wall receptacle is encountered, contact a qualified electrician and have it replaced with a properly grounded three-prong receptacle in accordance with all local codes and ordinances.



**WARNING!**

**Electrocution hazard.**

**Electrical grounding required.**

- **Do not remove the round grounding prong from the plug.** →
- **Do not use extension cords or ungrounded (two-prong) adapters.**
- **Do not use a power cord that is frayed or damaged.**

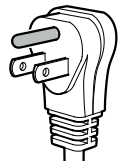

- **Do not use a power strip.** →

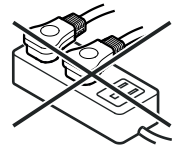

**Failure to follow these instructions may result in fire, electrical shock or death.**

## Safety Regulations

The appliance is designed to cool and store beverages. It is designed as a household appliance.

### IMPORTANT

- Do not store perishable foods in this appliance.
- The appliance is not intended for outdoor use.

The appliance is manufactured to operate within specific ambient temperature limits according to its climate rating.

The climate rating indicates the ambient temperature at which the appliance may be operated in order to deliver optimal refrigeration performance.

Climate Rating	Ambient Temperature
SN-ST	50°F to 100°F (10°C to 38°C)

### IMPORTANT

**Do not operate the appliance outside the specified ambient temperature range.**

- The refrigerant circuit has been tested for leaks.
- The appliance complies with current safety regulations

C22.2 No. 120-13  
UL 471 -10<sup>th</sup> Edition

We recommend cleaning the appliance before turning it on for the first time. See **Cleaning**.

Turn on the appliance several hours before filling it.

### WARNING!

**Do not allow children to play with the appliance. Children must not climb, sit or stand on the shelves or door.**

**Failure to follow these instructions may result in death or serious injury.**

## Disposal of Carton

The packaging is designed to protect the appliance and individual components during transport and is made of recyclable materials.

### WARNING!

**Keep packaging materials away from children. Polythene sheets and bags can cause suffocation!**

If possible, please recycle packaging material at a recycling facility.

## Setting Up

### CAUTION!

**To avoid risk of personal injury or property damage, have two people unpack and move this appliance into place.**

### IMPORTANT

Protect the finished floor surface before you uncrate the unit.

Avoid placing the appliance in direct sunlight or near the stove, range top, radiators and similar heat sources.

As soon as you uncrate the unit:

- Examine the unit and packaging for shipping damage. Contact the carrier immediately if you suspect there is any damage.
- Note the type (model number), service number, appliance / serial number, date of purchase and where purchased in the space provided in the back of this manual.

## Description of the Appliance

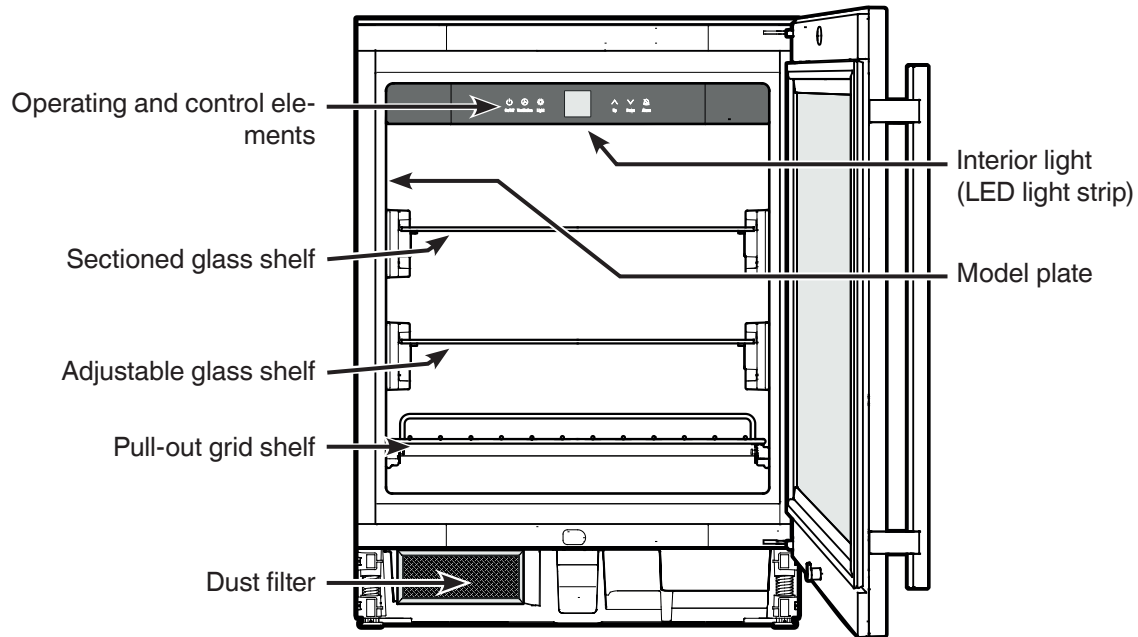

## Operating and Control Elements



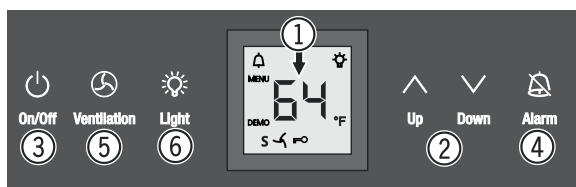

The electronic control panel features "touch capacitive technology". Any function can be activated by touching the corresponding icon.

The exact contact point is between the symbol and its label  On/Off



- (1) Temperature display
- (2) Temperature setting buttons
- (3) On/Off button (switching the appliance on and off)
- (4) Audible alarm Off button
- (5) Fan switch
- (6) Interior light On/Off button

### Symbols in the display

-  Alarm (symbol flashes if the temperature inside the appliance is too high or too low)
- DEMO** Demo mode is activated
- S** Sabbath mode is activated
- MENU** Setup mode is activated (activating the child lock, adjusting the display brightness and activating the Sabbath mode)
-  The interior fan runs continuously
-  Child lock is activated
-  The interior light is switched on continuously

## Switching the appliance On and Off

### Switching the appliance on

Press the **On/Off** button until the temperature display lights up.



### Switching the appliance off

Keep the **On/Off** button pressed for approx. 3 seconds until the temperature display goes out.

On/Off

## Setting the Temperature

### Reducing the temperature

Press the **Down** button.



### Increasing the temperature

Press the **Up** button.

Up

Down

- When you press one of the buttons for the first time, the display will start to flash.
- Pressing this button again enables you to change the temperature setting.
- The electronic control system will switch over automatically about 5 seconds after the last time you pressed the button, and the actual temperature will be displayed.

The temperature can be set between 36°F and 68°F (2°C and 20°C).

## Ventilation Button

Switch on the Ventilation function when loading the appliance with a large number of beverages. This ensures an even interior temperature and has a positive effect on the cooling down process.

Switch off the Ventilation function approx. 12 hours after loading the appliance.

### To switch on

Press the **Ventilation** button. The symbol  will light up.

### To switch off

Press the **Ventilation** button again. The symbol  will go out.

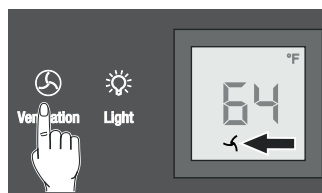

## Door Open Alarm

If the door is left open for more than 180 seconds, the audible alarm signal will sound.

If the door must be opened for a lengthy period in order to place items into the appliance, cancel the audible alarm signal by pressing the **Alarm** button.

Alarm



The alarm switches back to standby when the door is shut.

## Temperature Alarm

If the temperatures in the interior are out of the permitted range, the audible alarm signal will sound and the temperature display will flash.

- Cancel the audible alarm signal by pressing the **Alarm** button.

After a lengthy power failure, the temperature in the interior may have risen to a too high level. After the power supply is restored, the drop in temperature can be watched on the display.

The temperature display will stop flashing as soon as the temperature in the interior has reached the set value.

### Temperature alarm after a fault in the appliance

If a fault occurs in the appliance, the temperature in the interior may rise too high or drop too low. The audible alarm signal will sound and the temperature display will flash.

- Cancel the audible alarm signal by pressing the **Alarm** button.

If the temperature displayed is too high (warm), first check whether the door is closed correctly.

If the temperature display continues to show a value that is too high or too low after one hour, contact the customer service department.

If **F1** appears in the display, a fault has occurred in the appliance.

In this case, contact the customer service department.



## Setup Mode

### ☸ = Sabbath mode

This feature considers the religious requirements on the Sabbath or holidays. When the Sabbath mode is active, some functions of the electronic controls are switched off.

- The lighting remains off.
- The cooling fan remains in its actual state: If it is on, it remains on, if it is off, it remains off.
- There is no door alarm.
- There is no temperature alarm.

### Activating the Sabbath mode

Press  for 5 seconds. Display = 



Press  Display = 

Press  Display = 

Press  Display = 

The Sabbath Mode is now activated.

### Deactivating the Sabbath mode

Press  for 5 seconds. Display = 

Press  Display = 



Press  Display = 

Press  = Exit setup mode.

The appliance will change back to normal operation.

### h = Display brightness

### Adjusting the display brightness

Press  for 5 seconds. Display = 

Press  Display = 

Press  Display = 

Use buttons **Up** and **Down** to select the desired setting.

**h0** = display lighting off

**h1** = minimum brightness

**h5** = maximum brightness

Press  Display = 

Press  = Exit setup mode.

The appliance will change back to normal operation.

The adjusted brightness will be activated after one minute.

### Note

If a button is pressed, the display lights up for one minute at maximum brightness.





## □ = Temperature display mode

You can choose the **unit of temperature** for the display in degrees Fahrenheit or degrees Celsius.

### Note

The factory setting is degrees Fahrenheit.

Press  for 5 seconds. Display = 

Press  Display = 

Press  Display = 

Press  Display = 

Press  Display = 

Press  = Exit setup mode.

The appliance will change back to normal operation.

The temperature reading is now displayed in degrees Celsius.



### Note

To change the temperature display back to degrees Fahrenheit, follow the steps above.

## ⏏ = Child lock

The child lock is designed to protect the appliance from being switched off and the temperature setting from being changed accidentally.

### Activating the child lock

Press  for 5 seconds. Display = 

Press  Display = 



Press  Display = 

Press  Display = 

Press  = Exit setup mode.

The appliance will change back to normal operation.

### Deactivating the child lock

Press  for 5 seconds. Display = 

Press  Display = 

Press  Display = 

Press  Display = 

Press  = Exit setup mode.

The appliance will change back to normal operation.

# OPERATION

## Interior Light

The interior light will always switch on when the appliance door is opened.

The interior light will go out approx. 5 seconds after the door is closed.

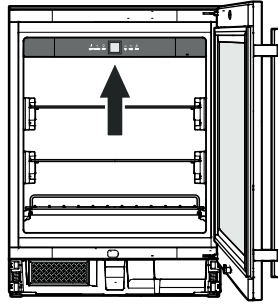

Press the **Light** button if you want the interior light to be on even when the door is closed. →



Furthermore, the brightness of the lighting can be adjusted.

- Press the **Light** button.
- Press and hold the **Light** button and at the same time press the temperature setting buttons to increase or decrease the brightness.



The light intensity of the LED light corresponds to laser class 1/1M.

### IMPORTANT

The light cover may only be removed by customer service staff.

### CAUTION!

Risk of eye damage.

If the cover is removed, do not look directly at the light through optical lenses from a close distance.

## Safety Lock

The lock in the appliance door is equipped with a safety mechanism.

### Locking the appliance

- Insert the key and push as shown by arrow 1.
- Turn the key 90° clockwise 2.

### Unlocking the appliance

- Insert the key and push.
- Turn the key 90° counterclockwise.

### Note

Hold the key at all times. The lock cylinder is spring loaded and will eject the key if you release it.

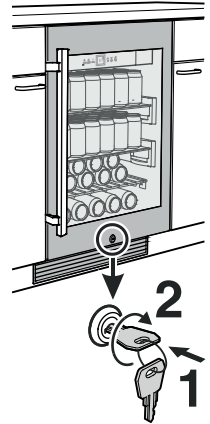

### WARNING!

Risk of child entrapment and suffocation due to a locked appliance door.

Keep the key in a safe place out of reach of children and not in the vicinity of the appliance.

## Additional Features

### Pull-out shelf

The pull-out shelf allows bottles or cans to be viewed and removed more easily.

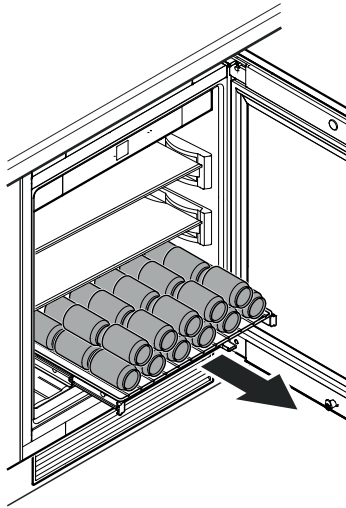

### Repositioning the glass shelf

(1) Lift the shelf at the front.

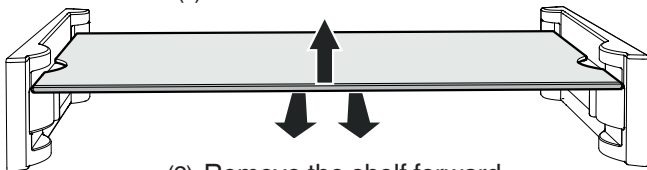

(2) Remove the shelf forward

Insert the shelf in the bottom channel of the supports.

Be sure the rear angles of the shelf rests on the marked areas of the supports.

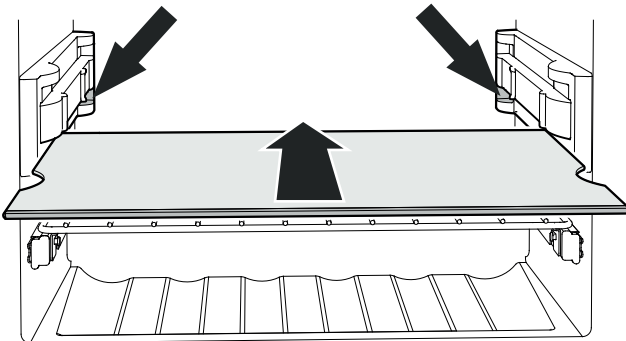

### IMPORTANT

Do not place the shelf on the top of the supports.

### Sectioned glass shelf

If you need to make space for tall containers, simply carefully slide the **front half** of the sectioned glass shelf underneath the back half.

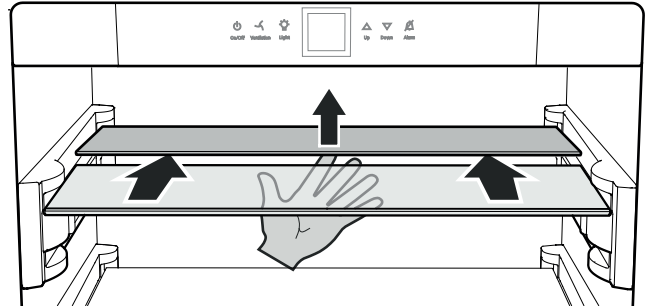

### IMPORTANT

(1) The sectioned glass shelf may only be inserted in the top channel of the supports.

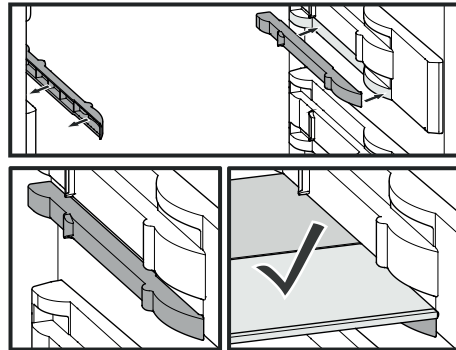
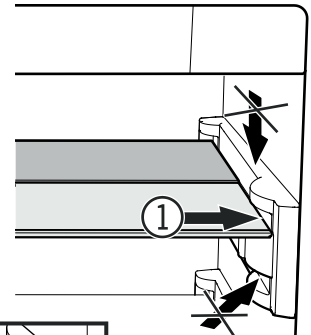

# CLEANING

## Cleaning

### ⚠ WARNING!

- To prevent possible injury due to an electrical shock, be sure to disconnect the power cord or turn off the circuit breaker before cleaning the appliance.
- To avoid injury or damage, do not use steam cleaning equipment to clean the appliance.

### Cleaning the appliance outside

- Clean the door surface with a clean and soft cloth. If necessary, use a moist cloth (water + detergent).
- Use a glass cleaner to clean the glass surface.

### IMPORTANT

Do not use abrasive or scouring pads or sponges. Do not use concentrated cleaning agents. Never use abrasive or acid-based cleaners or chemical solvents.

The dust filter in the appliance base must be cleaned at least once a year.

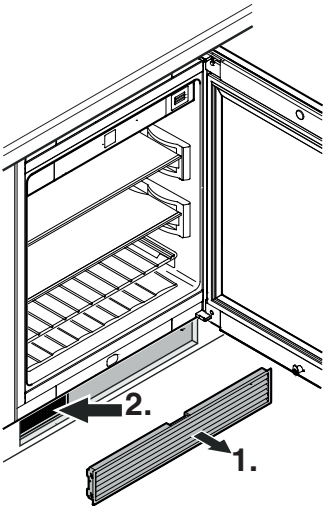

1. Remove the ventilation grille from the toe kick panel.
2. Clean the dust filter using a vacuum cleaner.
3. Reattach the ventilation grille.

### Cleaning the appliance interior

Remove the glass shelves. Lift at the front and then remove the shelf towards you.

### Removing the bottom shelf

Pull the shelf upwards on the right and left at the back and then remove it towards you.

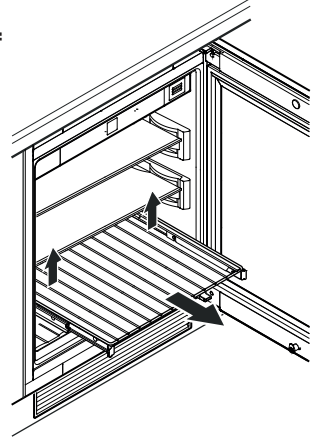

- Clean the inside of the appliance and equipment parts with lukewarm water and a little detergent.
- Thoroughly dry all parts with a cloth.
- **Do not** damage or remove the model plate on the inside of the appliance. It is very important for servicing your appliance.

### Inserting the grid shelf

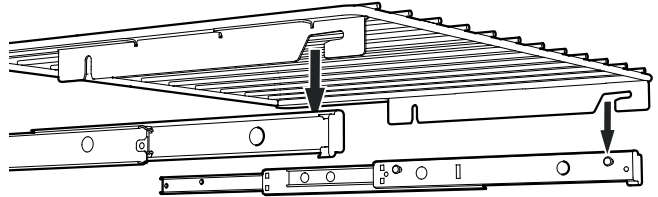

Extend the pull-out rails as far as they will go. Place the front recesses of the shelf on the securing pins.

Slide the shelf together with the pull-out rails into the appliance as far as they will go.

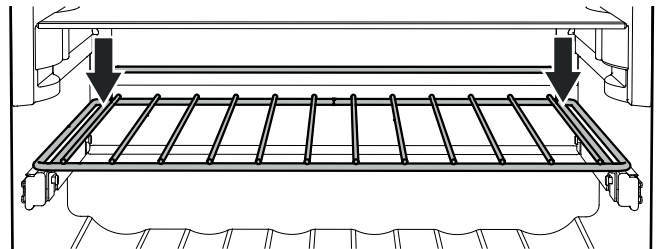

Push the shelf downwards on the right and left at the back and click into place.

Your appliance is designed and manufactured for a long life and reliable operation.

If a problem occurs during operation, check whether it is due to an operating error.

Please note that even during the warranty period, you may be responsible for certain repair costs.

Problem	Possible cause and remedy
Appliance does not work, display is off.	<ul style="list-style-type: none"> <li>- Is the appliance turned on?</li> <li>- Is the power cord properly inserted in the outlet?</li> <li>- Is the circuit breaker or fuse in working order?</li> </ul>
Motor seems to run too long.	<ul style="list-style-type: none"> <li>- Is the ambient temperature too hot? See <b>Safety Regulations</b>.</li> <li>- Has the appliance been opened too often or left open too long?</li> </ul>
The temperature is not cold enough.	<ul style="list-style-type: none"> <li>- Is the temperature setting correct? See <b>Setting the Temperature</b>.</li> <li>- Has an excessive amount of wine been placed in the appliance?</li> <li>- Does a separately installed thermometer show the correct reading?</li> <li>- Is the ventilation system working properly?</li> <li>- Is the dust filter in the appliance base dirty? See section entitled <b>Cleaning</b>.</li> <li>- Is the appliance set up too close to a heat source?</li> </ul>
The fans inside the appliance are running even though the fan function has been deactivated and the compressor (refrigeration unit) is idle.	<ul style="list-style-type: none"> <li>- This is a normal operating state depending on the set interior temperature and ambient temperature at the place of installation.</li> </ul>
<b>F1</b> appears in the display	<ul style="list-style-type: none"> <li>- A fault has occurred in the appliance. Contact the Liebherr Service Center.</li> </ul>
When inserting the mains plug, the refrigeration unit does not switch on, but a value is shown in the temperature display.	<ul style="list-style-type: none"> <li>- Demo mode is activated. Contact the Liebherr Service Center.</li> </ul>

## Customer Service

If none of the above possible causes apply, and you can not rectify the fault yourself, contact the Liebherr Service Center. Indicate the type (1) of appliance, service number (2) and the appliance / serial number (3) as shown on the model plate.

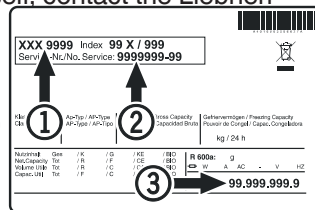

The position of the model plate is shown in the section entitled **Description of the Appliance**.

## Appliance Information

Record this information when the appliance is installed.

Type Designation: \_\_\_\_\_

Service Number: \_\_\_\_\_

Appliance / Serial Number: \_\_\_\_\_

Date of Purchase: \_\_\_\_\_

Where Purchased: \_\_\_\_\_

## Turning Off the Appliance

If your appliance is to be turned off for any length of time, switch it off and disconnect the plug or switch off or unscrew the fuse.

Clean the appliance and leave the door open in order to prevent unpleasant odors.





## **For Service in the U.S.**

### **Liebherr Service Center**

Toll Free: **1-866-LIEBHER** or **1-866-543-2437**

Email: [Service-appliances.us@liebherr.com](mailto:Service-appliances.us@liebherr.com)

### **PlusOne Solutions, Inc.**

3501 Quadrangle Blvd, Suite 120

Orlando, FL 32817

## **For Service in Canada**

### **Liebherr Service Center**

Toll Free: **1-888-LIEBHER** or **1-888-543-2437**

[www.euro-parts.ca](http://www.euro-parts.ca)

### **EURO-PARTS CANADA**

39822 Belgrave Road

Belgrave, Ontario, N0G 1E0

Phone: (519) 357-3320

Fax: (519) 357-1326



[www.liebherr-appliances.com](http://www.liebherr-appliances.com)