

**Gaggenau**

en-us Use and Care Manual

# C|282602

Cooktop

( ) = cm

**CI282602**

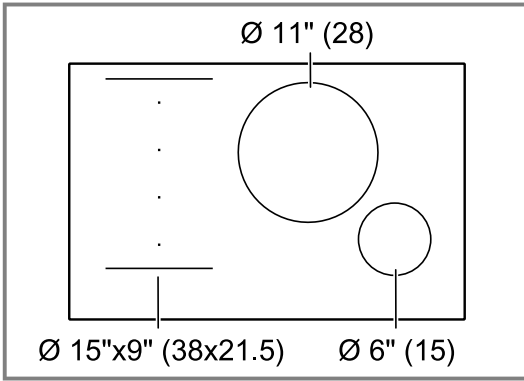

# Table of contents

<b>1 IMPORTANT SAFETY INSTRUCTIONS.....</b>	<b>4</b>
1.1 Safety definitions.....	4
1.2 General information.....	4
1.3 Intended use .....	4
1.4 Restriction on user group .....	4
1.5 Safe use.....	4
1.6 Child safety .....	7
1.7 Electromagnetic interference.....	8
1.8 Proper installation and maintenance .....	8
1.9 State of California Proposition 65 Warnings .....	9
<b>2 Preventing material damage .....</b>	<b>10</b>
2.1 Overview of the most common types of damage.....	10
<b>3 Environmental protection and energy-saving .....</b>	<b>10</b>
3.1 Disposal of packaging .....	10
3.2 Saving energy .....	10
<b>4 Induction cooking .....</b>	<b>10</b>
4.1 Advantages of induction cooking.....	10
4.2 Cookware.....	11
<b>5 Familiarizing yourself with your appliance .....</b>	<b>12</b>
5.1 Control panel.....	12
5.2 Cooking zones .....	13
<b>6 Twistpad with twist knob.....</b>	<b>13</b>
6.1 Using the twist knob .....	13
6.2 Removing the twist knob .....	13
6.3 Storing the twist knob .....	13
<b>7 Operation.....</b>	<b>13</b>
7.1 Turning the cooktop on or off .....	13
7.2 Cooking zone settings.....	14
7.3 Recommended cooking settings .....	14
7.4 Flex function.....	15
7.5 Transfer function .....	16
7.6 Short-term timer .....	16
7.7 Stopwatch .....	17
7.8 Booster function for pots .....	17
7.9 Booster function for pans .....	17
7.10 Keep warm.....	18
7.11 Cooking assistance functions.....	18
7.12 Wireless cooking sensor .....	29
7.13 Panel lock .....	31
7.14 Wipe protection .....	31
7.15 Basic settings.....	32
7.16 Power limitation.....	33
<b>8 Home Connect™ .....</b>	<b>33</b>
8.1 Setting up Home Connect™.....	34
8.2 Overview of the Home Connect™ settings.....	34
8.3 Changing settings via the Home Connect™ app.....	35
8.4 Software update.....	35
8.5 Remote diagnostics.....	35
8.6 Data Protection .....	35
8.7 Wi-Fi module.....	35
<b>9 Hood Control.....</b>	<b>36</b>
9.1 Connecting appliances directly.....	36
9.2 Connecting appliances via your home network (Wi-Fi).....	36
9.3 Resetting the connection .....	36
9.4 Controlling the hood via the cooktop .....	36
9.5 Overview of the hood control settings .....	37
<b>10 Cleaning and maintenance .....</b>	<b>38</b>
10.1 Cleaning agents.....	38
10.2 Cleaning the glass ceramic cooktop.....	38
10.3 Cleaning the twist knob.....	38
10.4 Cleaning recommendations .....	38
10.5 Maintenance .....	39
<b>11 Troubleshooting .....</b>	<b>40</b>
<b>12 FAQs.....</b>	<b>43</b>
<b>13 Disposal.....</b>	<b>44</b>
13.1 Disposal of your old appliance .....	44
<b>14 Customer Service .....</b>	<b>44</b>
14.1 Model number (E-Nr.) and production number (FD) .....	44
14.2 Rating plate location .....	44
<b>15 STATEMENT OF LIMITED PRODUCT WARRANTY.....</b>	<b>44</b>
15.1 What this warranty covers & Who it applies to .....	44
15.2 How long the warranty lasts .....	45
15.3 Repair/replace as your exclusive remedy.....	45
15.4 Out of warranty product .....	45
15.5 Warranty exclusions .....	45
15.6 Obtaining warranty service .....	46
15.7 Product information.....	46



# IMPORTANT SAFETY INSTRUCTIONS

## READ AND SAVE THESE INSTRUCTIONS

---

Read all instructions carefully before use. These precautions will reduce the risk of electrical shock, fire and injury to persons. When using kitchen appliances, basic safety precautions must be followed including those in the following pages.

### 1.1 Safety definitions

Here you can find explanations of the safety signal words used in this manual.

#### **WARNING**

This indicates that death or serious injuries may occur as a result of non-observance of this warning.

#### **CAUTION**

This indicates that minor or moderate injuries may occur as a result of non-observance of this warning.

#### **NOTICE:**

This indicates that damage to the appliance or property may occur as a result of non-compliance with this advisory.

**Note:** This alerts you to important information and/or tips.

### 1.2 General information

- Read this manual carefully.
- Keep the instructions, the appliance pass and the product information safe for future reference or for the next owner.
- Do not connect the appliance if it has been damaged in transit.

### 1.3 Intended use

Only a qualified electrician may connect appliances without plugs. The manufacturer is not responsible for damage caused by incorrect connections. Please see the Statement of Limited Product Warranty → *Page 44*.

The appliance can only be used safely if it is correctly installed according to the installation instructions. The installer is responsible for ensuring that the appliance works perfectly at its installation location.

Only use this appliance:

- To prepare meals and drinks.
- Under supervision. Never leave the appliance unattended when cooking for short periods.

- In private households and in enclosed spaces in a residential environment.
- up to an altitude of 13,100 ft (4000 m) above sea level.

Do not use the appliance:

- This appliance is not intended for operation with an external clock timer or a remote control.

When using the cooking sensor function, select the cooking zone on which you placed the cookware with the wireless cooking sensor.

### 1.4 Restriction on user group

This appliance is not intended for use by persons (including children) with reduced physical, sensory or mental capabilities, or lack of experience and knowledge, unless they have been given supervision or instruction concerning use of the appliance by a person responsible for their safety.

When children become old enough to use the appliance, it is the responsibility of the parents or legal guardians to ensure that they are instructed in safe practices by qualified persons.

Children should be supervised to ensure that they do not play with the appliance.

Do not let children play with the appliance.

### 1.5 Safe use

#### **WARNING**

When properly cared for, your new appliance has been designed to be safe and reliable.

- ▶ Read all instructions carefully before use. These precautions will reduce the risk of burns, electric shock, fire, and injury to persons.
- ▶ When using kitchen appliances, basic safety precautions must be followed, including those in the following pages.

#### **WARNING**

Overheated materials can cause fire or burns.

- ▶ Do not allow aluminum foil, plastic, paper or cloth to come in contact with a hot surface element, burner or grate.
  - ▶ Do not allow pans to boil dry.
- Unattended cooking on a cooktop with fat or oil can be dangerous and may result in a fire.
- ▶ Do not leave the cooktop unattended when in use.



# IMPORTANT SAFETY INSTRUCTIONS

## READ AND SAVE THESE INSTRUCTIONS

Never leave the cooktop unattended when in use. Boilovers cause smoking and greasy spillovers may ignite. A fire could occur during cooking.

- ▶ Always have a working smoke detector near the kitchen.
- ▶ Have an appropriate fire extinguisher available, nearby, highly visible and easily accessible near the appliance.

If the cooktop is near a window, forced air vent or fan, be certain that flammable materials such as window coverings do not blow over or near the burners or heating elements. They could catch on fire.

Cooking fires can spread if extinguished incorrectly.

- ▶ Never use water on cooking fires.

### WARNING

TO REDUCE THE RISK OF A GREASE FIRE

- ▶ Never Leave Surface Units Unattended at High Settings - Boilovers cause smoking and greasy spillovers that may ignite. Heat oils slowly on low or medium settings.
- ▶ Always turn hood ON when cooking at high heat or when flambing food (i.e. Crepes Suzette, Cherries Jubilee, Peppercorn Beef Flambe').
- ▶ Clean ventilating fans frequently. Grease should not be allowed to accumulate on fan or filter.
- ▶ Use proper pan size. Always use cookware appropriate for the size of the surface element.
- ▶ Do not flambé under the extractor hood or work with a naked flame. When switched on, the extractor hood draws flames into the filter. There is a risk of fire due to deposits on the grease filter!

Flames can be drawn into the ventilation system.

- ▶ Whenever possible, do not operate the ventilation system during a cooktop fire. However, do not reach through fire to turn it off.

Cookware Handles Should be Turned Inward and Not Extend Over Adjacent Surface Units.

- ▶ To reduce the risk of burns, ignition of flammable materials, and spillage due to unintentional contact with the cookware, the handle of a cookware should be positioned so that it is turned inward, and does not extend over adjacent surface units.

Wear Proper Apparel. Loose-fitting or hanging garments, such as ties, scarves, jewelry, or dangling sleeves, should never be worn while using the appliance.

- ▶ Tie long hair so that it does not hang loose.
- ▶ Secure all loose garments, etc. before beginning.

Use Proper Pan Size - This appliance is equipped with one or more surface units of different sizes.

- ▶ Select cookware having flat bottoms large enough to cover the surface unit cooking zone.
- ▶ The use of undersized cookware will expose a portion of the cooking zone to direct contact and may result in ignition of clothing. Proper relationship of cookware to cooking zone will also improve efficiency.

Controls may be operated unintentionally by spills covering the control panel.

- ▶ Never use the appliance if liquids or foods have spilled around the control panel.
- ▶ Always turn off the cooktop and dry the control panel. Boilovers can cause smoke and some foods and oils may catch fire if left on high temperature settings.
- ▶ When using a timer, always supervise the cooktop.
- ▶ Do not allow anything to boil over or burn.

### WARNING

If the frying sensor is not working properly, overheating may result causing smoke and damage to the pan or fire.

WHEN COOKING WITH THE FRYING SENSOR FUNCTION OBSERVE THE FOLLOWING

- ▶ Always use a sensor frying pan.
- ▶ Always put the pan in the center of the cooking zone.
- ▶ Do not place a lid on the pan.
- ▶ Never leave hot fat or oil unattended.

If the cooktop turns off automatically and can no longer be operated, it may turn itself on unintentionally at a later point.

- ▶ Switch off the circuit breaker or fuse in the electrical panel.
- ▶ Contact Customer Service for support.

### CAUTION

The cooking process has to be supervised. A short term cooking process has to be supervised continuously.

### WARNING

If the display does not work when a cooking area is heating up disconnect the circuit breaker or fuse in the electrical panel.

- ▶ Contact an authorized service provider.

To avoid risk of fire do not store items on the cooking surfaces.

In the event that personal clothing or hair catches fire, drop and roll immediately to extinguish flames.



# IMPORTANT SAFETY INSTRUCTIONS

## READ AND SAVE THESE INSTRUCTIONS

---

Do Not Use Water on Grease Fires.

- ▶ Smother fire or flame or use dry chemical or foam-type extinguisher.

### WARNING

Use Only Dry Potholders - Moist or damp potholders on hot surfaces may result in burns from steam.

- ▶ Do not let potholders touch hot heating elements.
- ▶ Do not use a towel or other bulky cloth.

Hot oil is capable of causing extreme burns and injury.

- ▶ Use high heat settings on the cooktop only when necessary.
- ▶ To avoid bubbling and splattering, heat oil slowly on no more than a low-medium setting.
- ▶ Never move a pan of hot oil, especially a deep fat fryer. Wait until it is cool.

Spills of hot food may cause burns.

- ▶ Hold the handle of the pan when stirring or turning food.

This helps prevent spills and movement of the pan.

DO NOT TOUCH SURFACE UNITS OR AREAS NEAR UNITS. Surface units may be hot even though they are dark in color. Areas near surface units may become hot enough to cause burns.

- ▶ During and after use, do not touch, or let clothing, potholders, or other flammable materials contact surface units or areas near units until they have had sufficient time to cool. Among these areas are the cooktop and areas facing the cooktop.

### WARNING

Do not place metallic objects such as knives, forks, spoons, and lids on the cooktop surface since they can get hot.

Clean Cooktop With Caution.

- ▶ If a wet sponge or cloth is used to wipe spills on a hot cooking area, be careful to avoid steam burn.
- ▶ Some cleaners can produce noxious fumes if applied to a hot surface.
- ▶ Do not clean the appliance while it is still hot.

### WARNING

The pan detection shut-off feature may not turn off the cooking zone due to spilled food or objects placed on the cooktop.

- ▶ Keep the cooktop clean and do not store objects on the cooking zones.

### CAUTION

If the temperature sensing system is not working properly, boilovers may result causing burns and injury. WHEN COOKING WITH THE COOKING SENSOR FUNCTION OBSERVE THE FOLLOWING

- ▶ Always put the lid on pots.
- ▶ Always fill pots with at least 1¼" (3 cm) of liquid.
- ▶ Always use pots of the appropriate size and type (enamelware pots, stainless steel and aluminum pots equipped with wireless temperature sensor).
- ▶ Always keep the sensor's window clean.
- ▶ When using the cooking sensor functions, make sure that the cookware with the wireless temperature sensor is placed on the cooking zone where you make the settings.

### WARNING

Storage in or on Appliance - The use of corrosive chemicals in heating or cleaning will damage the appliance and could result in injury.

- ▶ Flammable materials, corrosive chemicals, vapors or non-food products should not be stored or used in an oven or on or near surface units.
- ▶ The appliance is specifically designed for use when heating or cooking food.

This appliance is intended for normal family household use only.

- ▶ It is not approved for outdoor use.
- ▶ See the Statement of Limited Product Warranty. If you have any questions, contact the manufacturer.

### WARNING

Using this appliance other than for its intended use can cause fire or injury to persons.

- ▶ Use this appliance only for its intended use as described in this manual.
- ▶ NEVER use your appliances as a space heater for warming or heating the room. Doing so may result in overheating the appliance.
- ▶ Never use the appliance for storage.



# IMPORTANT SAFETY INSTRUCTIONS

## READ AND SAVE THESE INSTRUCTIONS

**WARNING - TO REDUCE THE RISK OF INJURY TO PERSONS IN THE EVENT OF A GREASE FIRE, OBSERVE THE FOLLOWING.**

- ▶ **SMOTHER FLAMES** with a close-fitting lid, cookie sheet, or metal tray, then turn off the burner. **BE CAREFUL TO PREVENT BURNS.** If the flames do not go out immediately, **EVACUATE AND CALL THE FIRE DEPARTMENT.**
- ▶ **NEVER PICK UP A FLAMING PAN** – You may be burned.
- ▶ **DO NOT USE WATER**, including wet dishcloths or towels – a violent steam explosion will result.
- ▶ Use an extinguisher **ONLY** if:
  - You know you have a Class ABC extinguisher, and you already know how to operate it.
  - The fire is small and contained in the area where it started.
  - The fire department is being called.
  - You can fight the fire with your back to an exit.

Do not heat or warm unopened food containers. Build-up of pressure may cause the container to burst and cause injury.

Liquid between the pot base and the cooktop may build up steam pressure. This may cause the pot to jump suddenly causing injury.

▶ Always keep the cooktop and bases of pots dry. When cooking with a double-boiler, the cooktop and cooking vessel may crack due to overheating.

▶ The cooking vessel in the double-boiler must not come in direct contact with the bottom of the pot filled with water.

▶ Use only heat-resistant cookware.

Injury and damage to the appliance may occur if control elements are not used properly.

### **WARNING**

Moisture intrusion may cause an electric shock.

▶ Do not use any steam cleaners or high-pressure cleaners to clean the appliance.

If the appliance or the power cord is damaged, this is dangerous.

▶ Do not turn the power on if the appliance or the power cord is damaged. Doing so may cause injury.

▶ Never operate a damaged appliance.

- ▶ If the surface is cracked, you must switch off the appliance in order to prevent a possible electrical shock. To do this, switch off the appliance via the circuit breaker in the circuit breaker panel rather than at the main switch.
- ▶ If the appliance or the power cord is damaged, immediately switch off the breaker in the circuit breaker box.
- ▶ Call Customer Service. → *Page 44*
- ▶ Repairs to the appliance must only be performed by an authorized service provider.

### **WARNING**

If the surface is cracked, switch off the appliance to avoid the possibility of electric shock.

**Do Not Cook on a Broken Cooktop** - If the cooktop should break, cleaning solutions and spillovers may penetrate the broken cooktop and create a risk of electric shock.

- ▶ Contact an authorized service provider immediately.

## **1.6 Child safety**

This appliance is not intended for use by persons (including children) with reduced physical, sensory or mental capabilities, or lack of experience and knowledge, unless they have been given supervision or instruction concerning use of the appliance by a person responsible for their safety.

When children become old enough to use the appliance, it is the responsibility of the parents or legal guardians to ensure that they are instructed in safe practices by qualified persons.

### **WARNING**

Do not allow children to use this appliance unless closely supervised by an adult.

- ▶ Children and pets should not be left alone or unattended in the area where the appliance is in use. They should never be allowed to play in its vicinity, whether or not the appliance is in use.

Do not allow anyone to climb, stand, lean, sit, or hang on any part of an appliance, especially a door, warming drawer, or storage drawer.

- ▶ This can damage the appliance, and the unit may tip over, potentially causing severe injury.

Do not let children play with the appliance.





# IMPORTANT SAFETY INSTRUCTIONS

## READ AND SAVE THESE INSTRUCTIONS

---

### CAUTION

Do not store items of interest to children in cabinets above an appliance or on the backguard of an appliance. Children climbing on the appliance to reach items could be seriously injured.

Do Not Leave Children Alone.

- ▶ Children should not be left alone or unattended in the area where the appliance is in use.
- ▶ They should never be allowed to sit or stand on any part of the appliance.

### WARNING

To avoid the risk of suffocation:

- ▶ Do not allow children to play with packaging material.

## 1.7 Electromagnetic interference

### WARNING

This induction cooktop generates and uses ISM frequency energy that heats cookware by using an electromagnetic field. It has been tested and complies with Part 18 of the FCC Rules for ISM equipment. This induction cooktop meets the FCC requirements to minimize interference with other devices in residential installation. Induction cooktops may cause interference with television or radio reception. If interference occurs, the user should try to correct the interference by

- ▶ Relocating the receiving antenna of the radio or television.
- ▶ Increasing the distance between the cooktop and the receiver.
- ▶ Connecting the receiver into an outlet different than the cooktop.
- ▶ It is the user's responsibility to correct any interference.

### CAUTION

Persons with a pacemaker or similar medical device should exercise caution when standing near an induction cooktop while it is in use.

- ▶ Consult your doctor or the manufacturer of the pacemaker or similar medical device for additional information about its effects with electromagnetic fields from an induction cooktop.

### WARNING

The removable twist knob is magnetic and may affect electronic implants, such as heart pacemakers or insulin pumps.

- ▶ Persons with electronic implants must maintain a distance of at least 4" (10 cm) from the magnetic twist knob.
- ▶ Never put the twist knob in your pockets.

The wireless cooking sensor is magnetic and can damage electronic implants, such as heart pacemakers or insulin pumps.

- ▶ Persons with electronic implants must maintain a distance of at least 4" (10 cm) from the wireless cooking sensor.
- ▶ Never put the wireless cooking sensor in your pockets.

## 1.8 Proper installation and maintenance

### WARNING

In the event of a malfunction, it might become necessary to turn off the power supply.

- ▶ Have the installer show you the circuit breaker or fuse. Mark it for easy reference.

To avoid electrical shock hazard, before servicing the appliance, turn power off at the service panel and lock the panel to prevent the power from being switched on accidentally.

Proper Installation - Improper installation or grounding can cause electric shock.

- ▶ This appliance must be properly installed and grounded by a qualified technician.
- ▶ Connect only to properly grounded outlet.
- ▶ Refer to installation instructions for details.

User Servicing - Do not repair or replace any part of the appliance unless specifically recommended in this manual.

- ▶ All other servicing should be referred to an authorized service provider.

If the supply cord is damaged, it must be replaced by the manufacturer, its authorized service provider or similar qualified persons in order to avoid hazard.





# IMPORTANT SAFETY INSTRUCTIONS

## READ AND SAVE THESE INSTRUCTIONS

---

### CAUTION

The cooktop is equipped with a cooling fan on its underside. Materials may be sucked into the fan and compromise the cooling of the appliance or damage the fan.

- ▶ If the cooktop is installed above a drawer, the drawer must not contain any objects or paper.
- ▶ There must be a minimum distance of  $\frac{3}{4}$ " (20 mm) between the content of the drawer and the fan input.

### WARNING

Malfunctions can cause injuries.

- ▶ Do not operate this appliance if it is not working properly, or if it has been damaged. Contact an authorized service provider.

## 1.9 State of California Proposition 65 Warnings

This product may contain a chemical known to the State of California, which can cause cancer or reproductive harm. Therefore, the packaging of your product may bear the following label as required by California:

**STATE OF CALIFORNIA PROPOSITION 65 WARNING:**



**WARNING**

Cancer and Reproductive Harm - [www.P65Warnings.ca.gov](http://www.P65Warnings.ca.gov)

## 2 Preventing material damage

### NOTICE:

Cookware with rough bottoms scratch the glass ceramic surface.

- ▶ Check the bottom of the cookware before setting it down.

Salt, sugar or grains of sand scratch the glass ceramic surface.

- ▶ Never use the cooktop as a working surface or for setting things down.

Overheating can damage the cookware.

- ▶ Do not heat empty pots or pans.

Hot cookware can cause the electronics to overheat.

- ▶ Never set down hot pans and pots on the control panel or the cooktop frame.

When hard or sharp objects fall on the cooktop, they can cause damage.

- ▶ Do not let hard or pointed objects fall on the cooktop.

Aluminum foil and plastic melt on hot cooking zones.

- ▶ Do not let aluminum foil or plastic come into contact with hot cooking zones.

- ▶ Do not use cooktop protective film.

Unsuitable cleaning agents can cause shimmering metallic discolorations on the glass ceramic surface.

- ▶ Refer to the cleaning recommendations in this manual.

→ "Cleaning and maintenance", Page 38

### 2.1 Overview of the most common types of damage

Here you can find an overview of the most common types of damage and suggestions how to avoid them.

#### Stains

Cause	How to avoid
Boiled-over food	Remove boiled-over food immediately with a glass scraper.
Unsuitable cleaning agents	Use cleaning agents that are suitable for glass ceramic cooktops.

#### Scratches

Cause	How to avoid
Salt, sugar and sand	Do not use the cooktop as a work surface or storage space.
Cookware with rough bases	Check the cookware.

#### Discolorations

Cause	How to avoid
Unsuitable cleaning agents	Use cleaning agents that are suitable for glass ceramic cooktops.
Pot abrasion (e.g. aluminum)	Lift pots and pans when moving them.

#### Blisters

Cause	How to avoid
Sugar, food with a high sugar content	Remove boiled-over food immediately with a glass scraper.

## 3 Environmental protection and energy-saving

### 3.1 Disposal of packaging

The packaging materials are environmentally compatible and can be recycled.

- ▶ Sort the individual components by type and dispose of them separately.

### 3.2 Saving energy

If you follow these tips, your appliance consumes less energy.

Select cookware with a base diameter that matches the cooking zone. Center the cookware on the cooking zone.

**Tip:** For frying pans, cookware manufacturers usually state the top diameter of the cookware. The diameter of the pan base is usually smaller.

- ✓ The energy is targeted at the cookware.  
If you use cookware that is too small, energy is wasted.  
If the cookware is too large, much energy is used to heat up the cookware.

Close cookware with a fitting lid.

- ✓ Cooking without a lid consumes more energy.

Only lift the lid when necessary.

- ✓ If you lift the lid, a lot of energy can escape.

Use a glass lid.

- ✓ If you use a glass lid, you can look inside the cookware without lifting the lid.

Use cookware with a solid flat bottom.

- ✓ Curved cookware bases increase energy consumption.

Use a cookware size that matches the amount of food you want to cook.

- ✓ Large cookware with little content consumes a lot of energy.

Cook with a small amount of water.

- ✓ More water requires more energy to heat it up.

Select a lower power level as soon as possible. Select a suitable power level to continue cooking.

- ✓ For ongoing cooking a lower power level is sufficient.

## 4 Induction cooking

### 4.1 Advantages of induction cooking

Induction cooking is fundamentally different from traditional cooking methods, since the heat builds up directly in the cookware. This offers numerous advantages:

- Saves time when boiling and frying.
- Saves energy.
- Easier to care for and clean. Spilled food does not burn on as quickly.

- Controlling the heat supply and safety; the cooktop increases or decreases the heat supply as soon as the user changes the setting. The induction cooking zone stops the heat supply when you remove the cookware from the cooking zone without you having to switch it off first.

## 4.2 Cookware

Only ferromagnetic cookware is suitable for induction cooking.

For example:

- Enameled steel cookware
- Cast iron cookware
- Special stainless steel cookware that is suitable for induction cooking

You can find additional information on which items of cookware are suitable for the induction cooking under In order to achieve a good cooking result, ensure that the ferromagnetic area of the cookware base corresponds to the size of the cooking zone. If the cookware is not detected on a cooking zone, place it on a cooking zone with a smaller diameter.

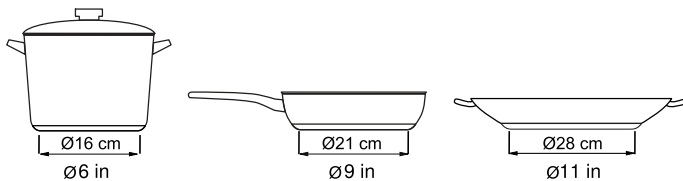

If you use the FlexZone as a single cooking zone, you can use larger cookware that is particularly suited to this zone. You can find additional information about the positioning of the appliances under .

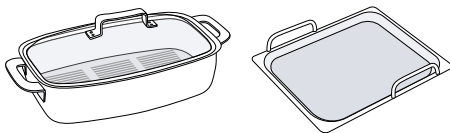

The base of many items of induction cookware is not fully ferromagnetic:

If you use large cookware with a smaller ferromagnetic base, only the area that is ferromagnetic heats up. As a result, the heat is not distributed evenly. The temperature of the non ferromagnetic area may therefore be too low for cooking.

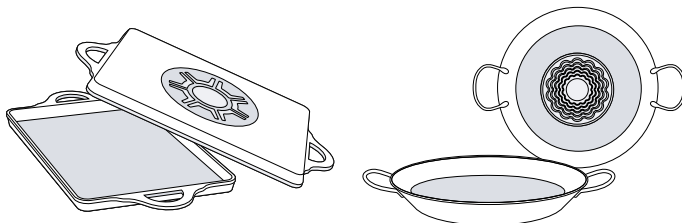

Cookware bases that contain aluminum reduce the ferromagnetic area. This may reduce the output and the cookware will not be detected sufficiently or at all, and will therefore not be heated sufficiently.

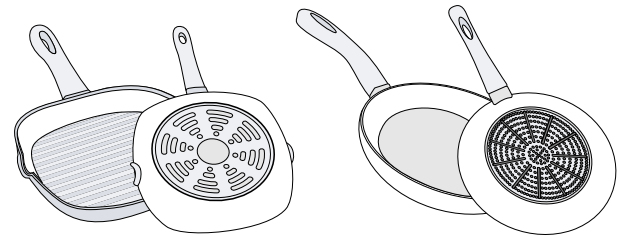

### Unsuitable cookware

Never use heat diffuser plates or cookware made of the following:

- Thin-walled normal steel
- Glass
- Clay
- Copper
- Aluminum

### Composition of the cookware base

The material(s) from which the base of the cookware is made may affect the cooking result. Cookware made of materials that distribute heat evenly in the pot, such as saucepans with a stainless steel sandwich base, save time and energy.

You should preferably use cookware with a flat base because uneven cookware bases impair the heat supply.

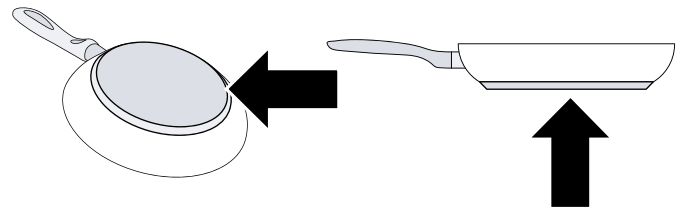

### No cookware/cookware of an unsuitable size

If you do not place cookware on the selected cooking zone or the cookware is made of an unsuitable material or is not the right size for the cooking zone, the display for the cooking zone flashes. To make the display go out, place a suitable item of cookware on the cooking zone. If you do not place a suitable item of cookware on the cooking zone within 90 seconds, it automatically switches off.

### Empty cookware or cookware with a thin base

Do not heat empty cookware and do not use cookware with a thin base. The cooktop is equipped with an internal safety system. However, empty cookware may heat up so quickly that the "Automatic switch-off" function does not respond quickly enough and an excessive temperature is reached. As a result, the base of the cookware may melt and damage the glass plate. In this case, do not touch the cookware; switch off the cooking zone. If the cooking zone no longer works after cooling down, contact Customer Service.

### Cookware detection

Each cooking zone has a minimum limit for the cookware detection and this depends on the ferromagnetic diameter and the material of the base of the cookware. Therefore, use the cooking zone that best corresponds to the diameter of the pan base.

## 5 Familiarizing yourself with your appliance

### 5.1 Control panel

You can use the control panel to configure all functions of your appliance and to obtain information about the operating status.

The control panel image is representative. Your appliance may vary slightly.

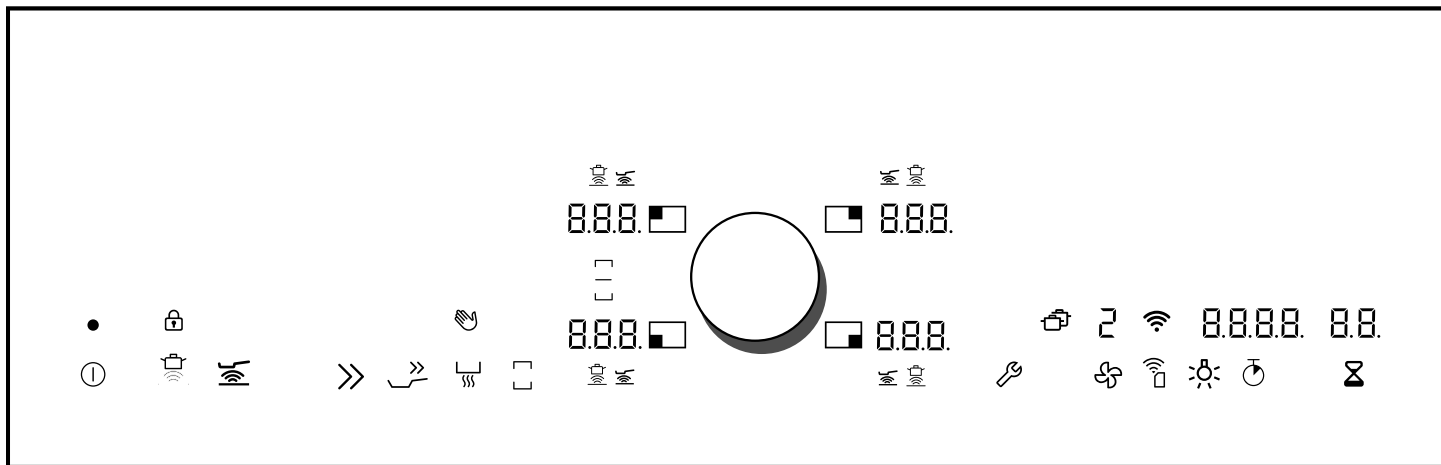

#### Touch keys

Touch keys are touch sensitive areas. Touch a symbol to activate the corresponding function.

- When the cooktop is turned on, the touch keys for the function that can currently be selected light up in white. Once a function is selected the touch key lights up in orange.
- When you press a touch key, the respective function is activated. A confirmation signal sounds.

Touch key	Function
	Main switch
	Booster function for pots
	Booster function for pans
	Cooking sensor function
	Frying sensor function
	Flex flexible cooking zone
	Short-term timer
	Stopwatch
	Keep warm function
	Home Connect™ confirmation key
	Hood control function
	Hood light control
	Basic settings

#### Notes

- Keep the controls clean and dry. Moisture can impair the function of the controls.

- Do not place cookware close to the displays and sensors. The electronics may overheat.

#### Displays

The displays show active settings and functions. When you select a cooking zone, the settings for this cooking zone light up orange.

Display	Name
0.0	Cooktop ready
	Cooking zone rear left
	Cooking zone front left
	Cooking zone rear right
	Cooking zone front right
1-9	Power levels
H/h	Residual heat indicator
P	Booster function for pots
b	Booster function for pans
	Cooking sensor function active
	Frying sensor active
00	Short-term timer value
00.00	Stopwatch value
L	Keep warm function active
	Display cleaning protection active
	Wi-Fi
0, 1, 2, 3, P, r, j	Fan levels
	Transfer function active

## 5.2 Cooking zones

Here you can find an overview of the cooking zones available on your cooktop. Place the cookware on the cooking zone that best matches its size. When a cooking zone is active, the corresponding displays light up.

Symbol	Cooking zone	Function
	Single cooking zone	Use cookware that matches the size of the cooking zone.
	Flexible cooking zone	

## 6 Twistpad with twist knob

The twist pad is the area in which you can use the twist knob to select the cooking zones and power levels. The twist knob automatically centers itself in the twistpad area.

### 6.1 Using the twist knob

The twist knob is magnetic and is located on the twist pad.

1. Position the twist knob on the twist pad. It should be centered between the displays around the twist pad area.

The twist knob will still work if it is not perfectly centered.

2. To activate a cooking zone, tilt the twist knob towards the desired cooking zone ①.

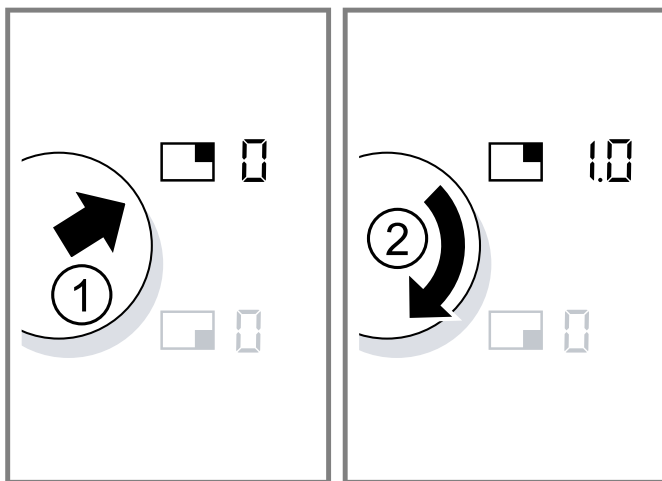

3. Turn the twist knob to select a power level ②.

### 6.2 Removing the twist knob

You can remove the twist knob during cooking.

#### ⚠ WARNING

If a metallic object is placed on the twist pad area, the cooktop may continue to heat up even though the twist knob has been removed.

- ▶ Always switch off the cooktop with the main switch.
- ▶ Remove the twist knob from the twist pad.
- ✓ The wipe-protection function is activated for 10 minutes.
- ✓ If you do not replace the twist knob within this interval the cooktop turns off.

Only use cookware that is suitable for induction cooking.  
→ "Induction cooking", Page 10  
Refer to the overview of models and dimensions.  
→ Page 2

### 6.3 Storing the twist knob

The twist knob contains a strong magnet that can cause interference or damage.

#### NOTICE:

Metal particles stuck to the bottom of the magnetic twist knob may scratch the surface of the cooktop.

- ▶ Always clean the twist knob thoroughly before you place it on the twist pad.
1. Keep the twist knob away from magnetic data carriers such as credit cards and cards with magnetic strips. The magnet in the twist knob may damage these objects beyond repair.
  2. The magnet in the twist knob may cause faults on televisions and screens.

## 7 Operation

Here you will find everything you need to know about operating your appliance.

### 7.1 Turning the cooktop on or off

Turn the cooktop on or off with the main switch.

#### Turning the cooktop on

1. Place the twist knob on the twist pad.
  2. Press ①.
    - When you first switch on the cooktop, lights up for a few seconds. This means that you have not set up Home Connect™, yet. This behavior will occur every time you turn on the cooktop, until you connect the cooktop to your home network, or if the connection has been interrupted.  
→ "Home Connect™", Page 33
    - Press and follow the instructions for Home Connect™ setup.
    - To exit the initial set-up, press any touch key.
- ✓ The indicator above ① turns on.
  - ✓ The symbols for the cooking zones and functions available at this time light up.
  - ✓ lights up in the cooking zone displays.

#### Turning the cooktop off

- ▶ Press and hold ① until all indicators go out.
- ✓ All cooking zones are turned off.
- ✓ The residual heat indicators remain lit until the cooking zones have cooled off sufficiently.

- ✓ The selected settings are stored for 5 seconds. If you turn on the appliance back on during this period, the previously set heating settings flash. To apply these settings, tap on the twist knob within 5 seconds. If you do not tap the twist knob or if you press a different touch key, all previous settings will be deleted.

**Note:** The cooktop turns off automatically when all the cooking zones have been turned off for more than 20 seconds.

## 7.2 Cooking zone settings

In order to make settings on a cooking zone, the cooking zone has to be selected.

Set the desired power level for each cooking zone in the settings area.

Setting	Power level
1	lowest power level
9	highest power level

Every power level has an intermediate setting. This is shown in the cooking zone display as .5.

**Note:** The cooktop may temporarily reduce the power automatically to protect the fragile parts of your appliance and to prevent the appliance from producing excess noise.

### Setting the power level

**Requirement:** The cooktop is turned on.

1. Place the cookware on the cooking zone.
  2. Select the cooking zone by tilting the control knob in the direction of the cooking zone display ①.
- ✓ The cooking zone indicator and  light up in the cooking zone display.
  - ✓ The cooking zone remains selected for 10 seconds.
3. Turn the twist knob until the required heat setting is displayed ②.

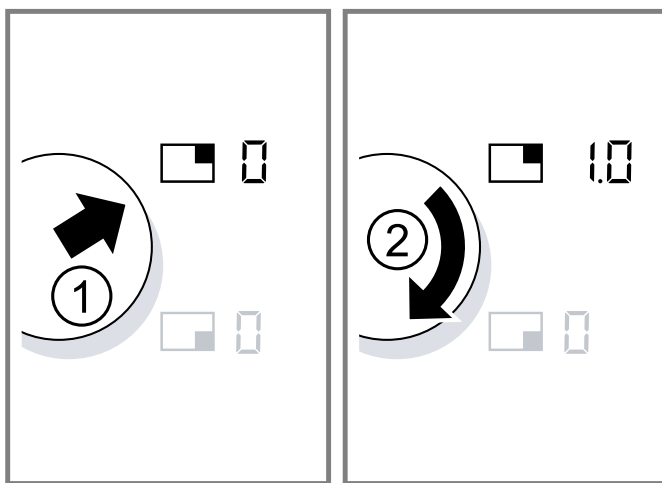

### Notes

- If there is no cookware on the cooking zone, the cooking zone display blinks. This means that the cooking zone tries to detect the cookware. Place cookware on the cooking zone within 30 seconds, or the cooking zone will switch itself off.
- If the indicators blink while cookware is present on the cooking zone, check whether the cookware is suitable for induction cooking.  
→ "Testing cookware suitability", Page 42

- If there is cookware on the cooking zone before switching the cooktop on, it is detected within 20 seconds after touching the main switch and the cooking zone is selected automatically. Set the power level within 10 seconds. Otherwise, the cooking zone switches off after 20 seconds.
- If there are several pieces of cookware on the cooktop when it is switched on, only one piece of cookware is detected.
- Place cookware on the flexible cooking zone in the correct position according to size.

### Changing the power level

- ▶ Tilt the twist knob to select the cooking zone and change the power level with the twist knob.

### Turning the cooking zone off

- ▶ Tilt the twist knob to select the cooking zone and turn the twist knob until  is displayed.
- ✓ The residual heat indicator lights up after approximately 10 seconds.

**Note:** You can also switch off the cooking zone directly by tilting the twist knob for longer than 3 seconds.

## 7.3 Recommended cooking settings

Here you can find recommendations on cooking and an overview of various dishes with suitable heat levels.

- Select power level 8 or 9 for bringing water to a boil or heating up the pan.
- Stir thick liquids occasionally.
- Food that needs to be seared quickly, or food which loses a lot of liquid during initial frying, is best seared in several small portions.
- When you cook with a lid on, turn the heat setting down as soon as steam escapes between lid and cookware.
- Keep the lid on the cookware after cooking until you serve the food.
- When you cook with a pressure cooker, observe the manufacturer's instructions.
- Do not cook food for too long or in too much water. Otherwise the nutrients will be lost. You can use the kitchen timer to set the optimum cooking time.  
→ "Short-term timer", Page 16
- Do not heat oil or grease until it smokes. You will achieve healthier cooking results.
- When you brown food, fry small portions one after the other.
- Cookware may become very hot during cooking. We recommend the use of pot holders.
- → "Saving energy", Page 10

### Cooking charts

The cooking chart shows which power level is suitable for each type of food. The cooking time may vary depending on the type, weight, thickness and quality of the food.

### ⚠ CAUTION

- Stews or liquids can heat up very quickly during cooking and may overflow or spatter, e.g. soups, sauces or drinks.
- ▶ Stir continuously.
  - ▶ Heat the food at a suitable power level.



**Melting**

Type of food	Power level
Chocolate	1.5
Butter	1.0 - 2.0

**Heating**

Frozen vegetables, e. g. spinach	2.5 - 3.5
Broth	7.0 - 8.0
Thick soup	1.5 - 2.5
Milk <sup>1</sup>	1.0 - 2.0

<sup>1</sup> Cook without lid

**Simmering**

Delicate sauce, e. g. Béchamel sauce	4.0 - 5.0
Spaghetti sauce	2.0 - 3.0
Pot roast	4.0 - 5.0
Fish <sup>1</sup>	4.0 - 5.0

<sup>1</sup> Ongoing cooking without lid

**Cooking**

Rice, with double amount of water	2.0 - 3.0
Potatoes boiled in their skins, with 1-2 cups of water	4.0 - 5.0
Boiled potatoes, with 1-2 cups of water	4.0 - 5.0
Fresh vegetables, with 1-2 cups of water	2.0 - 3.5
Frozen vegetables, with 1-2 cups of water	3.5 - 4.5
Pasta, with 2-4 qt. water <sup>1</sup>	6.0 - 7.0
Pudding <sup>2</sup>	1.0 - 2.0
Cereals	2.0 - 3.0

<sup>1</sup> Ongoing cooking without lid

<sup>2</sup> Cook without lid

**Frying**

Pork chop <sup>1</sup>	5.5 - 6.5
Chicken breast <sup>1</sup>	5.0 - 6.0
Bacon	6.0 - 7.0
Eggs	5.0 - 6.0
Fish	5.0 - 6.0
Pancakes	6.0 - 7.0

<sup>1</sup> Turn the food several times.

**Deep-fat frying**

Fry in 1-2 qt. oil without a lid.

Deep-frozen foods, e. g. chicken nuggets (0.5 lb per serving)	8.0 - 9.0
Other, e. g. doughnuts (0.5 lb per serving)	4.5 - 5.5

**Keep warm**

Tomato sauce	1.5
--------------	-----

**7.4 Flex function**

You can use the flexible cooking zone as one large cooking zone, or as two separate cooking zones. The flexible cooking zone has 4 induction elements, which are controlled independently from each other. When you use the Flex function, only the area that is covered by cookware is activated.

**Cookware recommendations for the flexible cooking zone**

Place the cookware in the middle of the cooking zone. This assures optimal pot detection and heat distribution.

**Flexible cooking zone as one large cooking zone**

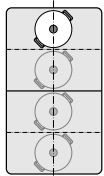
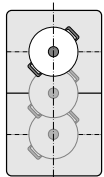
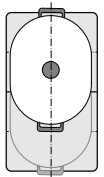
Possible cook-ware positions	Explanation
	The cookware diameter is smaller than or equal to 5 1/8" (13 cm). Place the cookware on one of the four positions shown in the illustration.
	The cookware diameter is larger than 5 1/8" (13 cm). Place the cookware on one of the three positions shown in the illustration.
	The cookware takes up more than one of the positions shown above. Position the cookware starting on the upper or lower edge of the flexible cooking zone.

**Flexible cooking zone as two separate cooking zones**

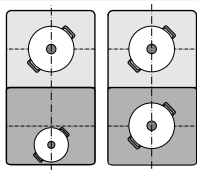
Possible cook-ware positions	Explanation
	The front and rear cooking zones each have two induction elements. They can be used independently of each other. Use only one item of cookware on each cooking zone. Select the required heat setting for each of the cooking zones.

**Using the flexible zone as two separate cooking zones**

- ▶ Make the settings for each cooking zone independently.  
→ "Cooking zone settings", Page 14

**Note:** The flexible cooking zone operates as two separate cooking zones as a default. If you want the Flex function to be activated automatically you can adjust the basic settings.

**Activating the Flex function**

1. Place the cookware on the flexible cooking zone.
2. Select one of the two cooking zones that belong to the flexible cooking zone.



3. Press .

✓  lights up in the cooking zone area.

4. Set the power level.



✓ The power level is displayed on both cooking zone displays.

**Note:** If both cooking zones are set to different power levels before being linked, both cooking zones switch to 0.

**Changing the power level for the flexible cooking zone**

1. Select one of the two cooking zones of the flexible cooking zone and adjust the power level with the twist knob.
2. Change the power level using the twist knob.

**Deactivating the Flex function**

1. Select one of the two cooking zones that belong to the flexible cooking zone.
2. Press .
  - ✓  lights up in the cooking zone area.
  - ✓ The flexible cooking zone is split into two separate cooking zones.

**Note:** If the cooking zone is switched off, and then switched back on again later, the flexible cooking zone is reset to function as two independent cooking zones.

**7.5 Transfer function**

You can use this function to transfer the settings from one cooking zone to another.

To transfer the settings, move the cookware from the cooking zone you are using to another cooking zone. You can also use this function on the flexible cooking zone. For additional information on how to position the cookware, refer to the information on using the flexible cooking zone.

→ "Flex function", Page 15

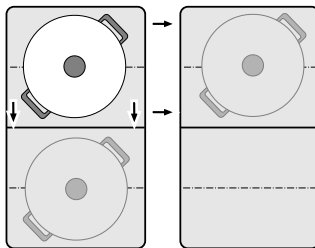

**General information for using this function:**

- Ensure that the new cooking zone is turned off, does not have any settings and there is no cookware on it.
- If you move several pieces of cookware, only the settings for the cookware you moved last are transferred.
- If you set down an additional item of cookware on a different cooking zone before you have confirmed the settings, the transferred settings are available for either item of cookware. Confirm the required cooking zone.
- You can only transfer the booster functions from left to right or vice versa if no other cooking zone is active.
- When you set down the cookware in its original position, the settings are kept.
- If the flexible cooking zone is activated when moving an item of cookware across the flexible cooking zone, the settings are applied automatically.

**Using the transfer function**

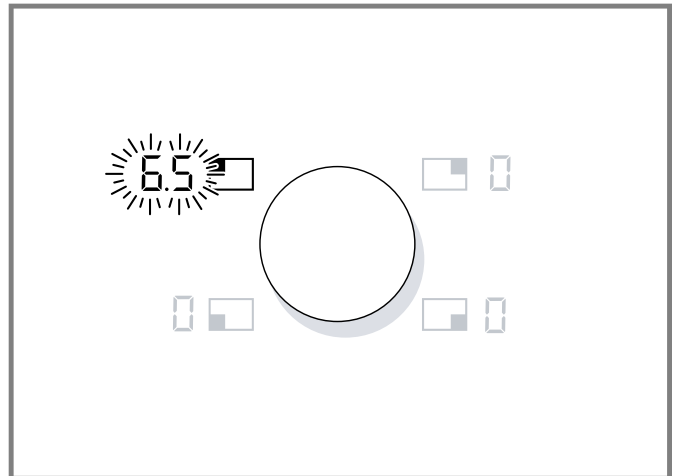

**Requirement:** The new cooking zone is turned off.

1. Lift the cookware off the active cooking zone.

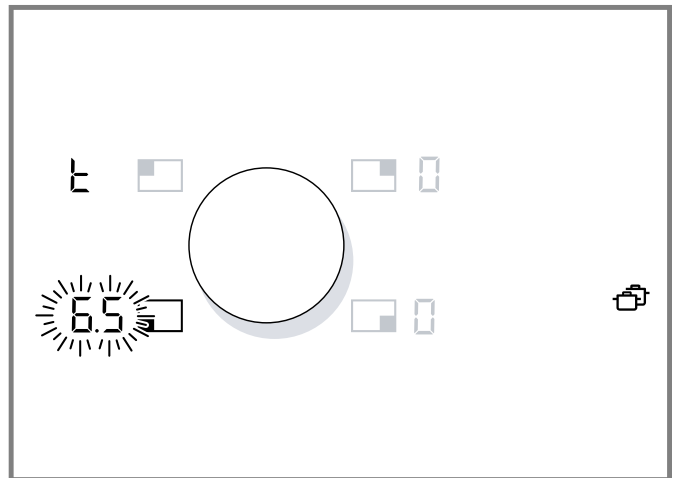

- ✓ The power level of the original cooking zone is blinking.
2. Set down the cookware on the new cooking zone.



- ✓ The cookware is detected on the new cooking zone.  lights up.
  - ✓ The transferred power level is blinking on the new cooking zone display.  lights up on the original cooking zone display.
3. Select the new cooking zone to confirm the settings.
- ✓ The power level of the original cooking zone is set to .

**7.6 Short-term timer**

You can use the Short-term timer to set a time of up to 99 minutes.

The Short-term timer is independent from other settings and does not switch off a cooking zone.

**Setting the Short-term timer**

**⚠ WARNING**

Boilovers can cause smoke and some foods and oils may catch fire if left on high temperature settings.

- ▶ When using a timer, always supervise the cooktop.
- ▶ Do not allow anything to boil over or burn.

1. Press **⏸**.
- ✓ **00** lights up in the Short-term timer display.
2. Set the desired time using the twist knob.
3. Press **⏸** to confirm.
- ✓ The time starts to count down.
- ✓ When the time has elapsed, a beep sounds. **00** blinks in the timer display.
4. Press **⏸** to turn off the signals.

### Changing or canceling the Short-term timer

1. Press **⏸**.
2. Set the desired time using the twist knob.  
To cancel the short-term timer, set the time to **00**.
3. Press **⏸** to confirm.

### Using the timer plus function

With the timer plus function you can determine how much time has elapsed since the Short-term timer has elapsed.

**Requirement:** The Short-term timer has run out and the timer end signal is still active.

1. Press and hold **⏸** for a few seconds.
- ✓ The Stopwatch is activated and is displayed on the Stopwatch display.
- ✓ The originally set Short-term timer value blinks on the Short-term timer display.
2. Press and hold **⏸** for a few seconds.
- ✓ Both timers are cleared.

## 7.7 Stopwatch

The Stopwatch displays the time that has elapsed since activating the function.

The Stopwatch works independently from the cooking zones and from other settings. This function does not automatically switch off a cooking zone.

### Starting the Stopwatch

#### **⚠ WARNING**

Boilovers can cause smoke and some foods and oils may catch fire if left on high temperature settings.

- ▶ When using a timer, always supervise the cooktop.
- ▶ Do not allow anything to boil over or burn.

- ▶ Press **⏸**.
- ✓ **00.00** lights up on the stopwatch display.
- ✓ The time begins to count up.

**Note:** The maximum duration is 99 minutes and 59 seconds (99.59). If this value is reached, the display starts again at 00.00.

### Canceling the Short-term timer

1. Press **⏸**.
- ✓ The timer is paused, the display remains on.
2. If you press **⏸** while it still lights up orange, the timer continues to count up.
3. Press and hold **⏸** to cancel the short-term timer.

## 7.8 Booster function for pots

With this function you can heat larger quantities of water faster than with power level 9. This function temporarily increases the top output of the selected cooking zone. You can also use this function on the flexible cooking zone if it is used as a joined cooking zone.

### Restrictions for using the Booster function

- This function can only be used on one cooking zone of the same cooktop segment at a time. The illustration shows these segments of your cooktop.
- If the function is not available, **b** and **9** blink on the display of the selected cooking zone. The power level **9** is set automatically.

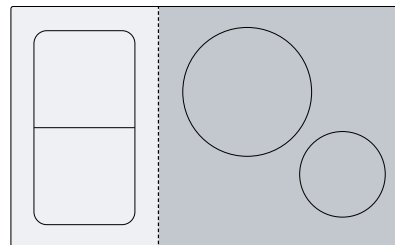

### Activating the booster function for pots

1. Select the cooking zone with the twist knob.
2. Press **»»**.
- ✓ **P** lights up in the cooking zone display.

### Deactivating the booster function for pots

1. Select the cooking zone with the twist knob.
2. Press **»»**.
- ✓ **P** goes out.
- ✓ The cooking zone switches to power level **9**.

### Notes

- In certain circumstances, this function may switch off automatically in order to protect the electronic elements inside the cooktop.
- If you have set a power level before activating the function, this power level is used automatically after the function has been deactivated.

## 7.9 Booster function for pans

With this function you can heat cookware faster than with power level **9**.

You can also use this function on the flexible cooking zone if it is used as a joined cooking zone.

Recommendations for using this function:

- Always use cookware that has not been pre-heated.
- Use cookware with a flat base.
- Do not use cookware with a thin base.
- Never leave empty cookware, oil, butter or lard to heat up unattended.
- Do not place a lid on the cookware.
- Place the cookware on the center of the cooking zone.
- Ensure that the diameter of the base of the cookware matches the size of the cooking zone.
- Refer to the information on cooking with induction for information on the type, size and positioning of the cookware. → Page 10

### Restrictions for using the Booster for pans function

- This function can only be used on one cooking zone of the same cooktop segment at a time. The illustration shows these segments of your cooktop.
- If the function is not available, **b** and **9** blink on the display of the selected cooking zone. The power level **9** is set automatically.

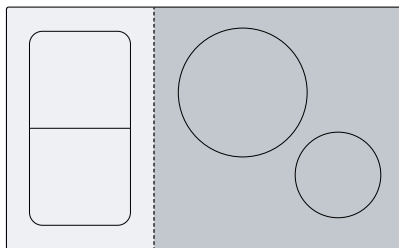

### Activating the booster function for pans

#### **⚠ WARNING**

Oil and fat heat up quickly with the Booster for pans function. Overheated oil and fat may ignite.

- ▶ Never leave the cooktop unattended during cooking.

1. Select the cooking zone.
  2. Press **↵**.
- ✓ **b** lights up on the cooking zone display.

### Deactivating Booster for pans

The function is turned off automatically after 30 seconds. You can turn it off manually before that.



- ▶ Press **↵**.
- ✓ **b** goes out.
- ✓ The cooking zone switches to power level **9**.

**Note:** If you have set a power level before activating the function, this power level is used automatically after the function has been deactivated.

### Types of cooking assistance functions



You can use the cooking assistance functions to select the best type of cooking for each kind of food.

#### Frying sensor technology for frying pans

Cooking process	Temperature levels °F (°C)	Cookware	Availability	Activating
Frying with a little oil	1, 2, 3, 4, 5		All cooking zones	

#### Cooking sensor function

If there is no wireless cooking sensor included with your cooktop, you can purchase it from specialist retailer, Customer Service, or our official website.

Cooking process	Temperature levels °F (°C)	Cookware	Availability	Activating
Keeping warm, heating	160 (70)		All cooking zones	

### 7.10 Keep warm

This function is suitable for melting chocolate or butter and for keeping food warm.

#### Activating the keep warm function

1. Select the cooking zone.
  2. Press **⏸**.
- ✓ **⏸** lights up on the display.

#### Deactivating the keep warm function

1. Select the cooking zone.
  2. Press **⏸**.
- ✓ **⏸** goes out.
  - ✓ The cooking zone turns off and the residual heat indicator lights up.

**Note:** You can also deactivate the function by turning the twist knob or selecting a different function.













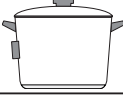

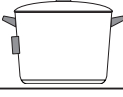
### 7.11 Cooking assistance functions

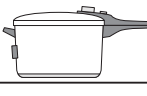
These functions help to make cooking easier and promise outstanding cooking results. The recommended temperature settings are suitable for any type of cooking.

Advantages with using the cooking assistance functions:

- The functions enable you to cook without using excessive heat and promise the perfect cooking and frying results.
- The sensors measure the temperature of the cookware continuously. This allows the cooking power to be regulated so that the right temperature is maintained at all times.
- You can add your food once the selected temperature has been reached. The temperature is automatically kept constant without you having to change the temperature setting.
- The functions are available on all cooking zones. For the cooking sensor function you require a wireless cooking sensor.

The table shows the various function settings that are available for the cooking assistants.

Cooking process	Temperature levels °F (°C)	Cookware	Availability	Activating
Poaching in milk	185 (85)		All cooking zones	
Poaching in water	195 (90)		All cooking zones	
Boiling	212 (100)		All cooking zones	
Cooking in a pressure cooker	240 (115)		All cooking zones	
Deep-fat frying at a low temperature	320 (160)		All cooking zones	
Deep-fat frying at a medium temperature	340 (170)		All cooking zones	
Deep-fat frying at a high temperature	355 (180)		All cooking zones	

### Suitable cookware for the cooking assistance functions

Select the cooking zone with the diameter that most closely matches that of the base of the cookware. Place the cookware in the center of this cooking zone.

#### Cooking sensor function

- Use cookware that is tall enough. The water level must be higher than the silicone patch for the wireless cooking sensor, once you have added the required volume of water.
- Any cookware that is suitable for induction cooking can be used for the cooking sensor. Refer to the information on induction cooking. → *Page 10*

#### Frying sensor function

- For the frying sensor function, you can purchase special sensor frying pans designed for this function.
- These frying pans have a non-stick coating so that you can fry food with only a small amount of oil.
- The frying sensor has been configured specifically for this type of frying pan. Other types of frying pans may overheat. They may reach a temperature below or above the selected temperature setting. Try the lowest temperature setting first and change it if necessary.
- If you use the frying sensor on the flexible cooking zone, make sure the pan matches the size of the cooking zone and is positioned correctly. Otherwise the frying sensor may not be activated.  
→ *"Flex function", Page 15*

### ⚠ CAUTION

When using a conventional frying pan observe the following notes.

- ▶ The Frying sensor function has been configured specifically for our system pans.

- ▶ Other frying pans may overheat. They may reach a temperature above or below the selected frying level. Try the lowest frying level first and then change it according to your requirements.
- ▶ Make sure that the diameter of the base of the frying pan corresponds to the size of the cooking zone. Place the pan in the center of the cooking zone.

These special pans can be purchased as an optional accessory from specialist retailers or through our Customer Service. Always quote the relevant reference number:

Reference number	Part
GP900001	6" (15 cm) frying pan
GP900002	7" (18 cm) frying pan
GP900003	9" (21 cm) frying pan
GP900004	11" (28 cm) frying pan. Only recommended for the single 11" (28 cm) cooking zone.
CA051300	Teppan Yaki. Recommended for the flexible cooking zone only.

**Note:** The chart in the section on cooking assistance functions lists which cookware is suitable for which functions.  
→ *"Types of cooking assistance functions", Page 18*

### Sensors and special accessories

The sensors measure the temperature of the cookware continuously. This regulates the cooking power very precisely in order to retain the correct temperature and achieve perfect cooking results.

Your cooktop has two different systems for temperature measurement in order to achieve the best results:

- Temperature sensors that are inside the cooktop and check the temperature at the base of the cookware. Suitable for frying sensor technology for frying pans.

- A wireless cooking sensor that transmits information about the temperature of the cookware to the control panel. Suitable for the cooking functions. The wireless cooking sensor is essential for using the cooking sensor functions.
- If your cooktop does not have a wireless cooking sensor included, you can purchase it from specialist retailers, our Customer Service, or our official website. Refer to the section on the wireless cooking sensor for more information.  
→ "Wireless cooking sensor", Page 29

### Frying sensor

With the Frying sensor function, a sensor controls the temperature of the pan. You can fry while the pan maintains the selected temperature.

### Frying levels

The Frying sensor function offers 5 frying levels.

Frying level	Temperature	Suitable for
1	Very low	Preparing and reducing sauces, sweating vegetables and frying food in extra virgin olive oil, butter or margarine.
2	Low	Frying food using extra virgin olive oil, butter or margarine, e.g. omelettes, French toast, hash browns.
3	Medium-low	Frying fish, pancakes and thick food such as Hamburgers or pork chops.
4	Medium-high	Frying ground meat, vegetables or thin slices of meat, e.g. veal cutlet.
5	High	Frying food at high temperatures, e.g. steaks medium rare or fried cooked potatoes.

### Setting the frying sensor function

#### ⚠ CAUTION

Hot oil or fat may ignite.

- ▶ Never leave hot fat or oil unattended.
- ▶ Do not place a lid on the frying pan. This will prevent the Frying sensor function from activating correctly. Use a mesh splatter guard to prevent fat from spitting out.
- ▶ Only use fat or oil that is suitable for frying.
- ▶ When you are using butter, margarine, olive oil or lard, select frying level 1 or 2.
- ▶ Do not use Frying sensor for boiling.

#### Requirements

- The cooktop is turned on.
- You have selected a suitable frying level from the chart.

1. Place the frying pan in the center of the cooking zone.
2. Select the cooking zone.

#### Advantages when using the Frying sensor function:





- The cooking zone only continues heating for as long as this is necessary to maintain the temperature. This saves energy and prevents the oil or fat from overheating.
- The frying function reports when the empty frying pan has reached the optimum temperature for adding oil and then for adding the food.

#### General notes for using the Frying sensor function:

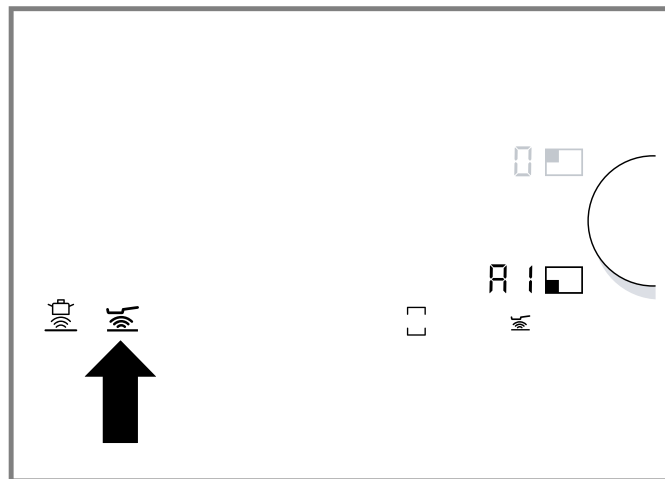
- Do not place a lid on the frying pan. This will prevent the function from activating correctly. Use a splatter guard to prevent fat from spitting out.
- Use suitable oil or fat. If you are using butter, margarine, cold-pressed olive oil or lard, use temperature setting 1 or 2.
- Never leave fat or oil unattended while you are heating it.
- If the cooking zone is a higher temperature than the cookware or vice versa, the cooking sensor is not activated correctly.

3. Press .



- ✓  and the frying level **Ri** light up on the cooking zone display.
- 4. Select the desired frying level with the twist knob.
- ✓  blinks.
- ✓ The cooking zone starts to heat up. The cooking zone display shows the heating progress from  to  and flashes alternately with the set frying level.



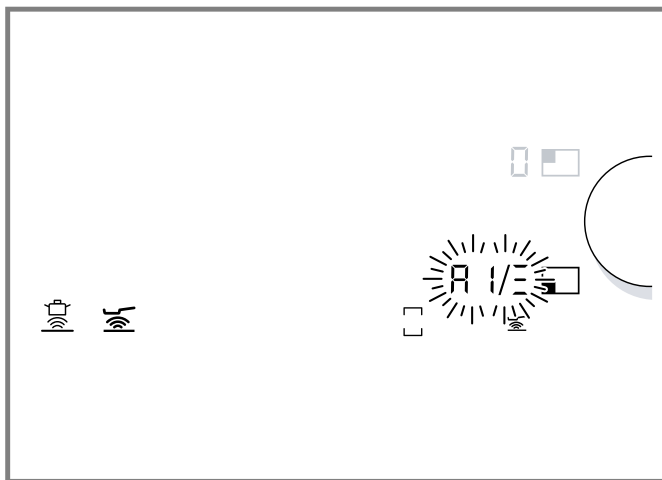

✓ Once the set frying level is reached, a signal sounds and the heat-up indicator goes out. The frying level is displayed.

5. Add the frying oil to the pan.

6. Add the ingredients.

Turn the food over as usual to avoid burning.

### Turning the frying sensor off

1. Select the cooking zone.

2. Press  or set the frying level to  with the twist knob.

✓ A signal sounds and  goes out.

### Cooking sensor function

You can use this function to heat, simmer or cook food, cook it in a pressure cooker, or fry it in a pot with sufficient oil at a controlled temperature.

#### Advantages when using the cooking sensor function:

- The cooking zone only heats up in order to maintain the temperature. This saves energy. Oil or fat will not over-heat.
- The temperature is continuously monitored. This prevents the food from spilling over and you do not need to change the temperature level.
- The cooking sensor functions tell you when the water or oil has reached the optimal temperature for adding the food; in some cases the food should be added at the beginning, refer to the cooking chart.

#### General notes for using the cooking sensor function:

- Use cookware with a thick, flat base. Do not use cookware with a thin or domed base.
- Fill the cookware so that the contents reach high enough to cover the cooking sensor's silicone patch.
- If you are frying with little oil using a frying pan, always use the frying sensor function.
- Position the cookware in such a way that the wireless cooking sensor is pointing towards the outer side of the cooktop.
- Do not remove the wireless cooking sensor from the cookware during cooking.
- Remove the wireless sensor from the cookware after cooking. Take care as you do so because the wireless cooking sensor can become very hot.
- If no signal sounds, ensure that there is a lid on the container. For optimum operation of the cooking sensor, we recommend always using a lid, except when you use the function for deep-fat frying with a large amount of oil in a pot at 340°F (170°C).
- Never leave oil unattended when it is being heated. Use oil that is suitable for deep-fat frying. Do not mix different cooking fats and oils, such as oil and lard. These mixtures may foam up when they become hot.
- If you are not satisfied with the cooking result use more water the next time, for example when boiling potatoes. Maintain the recommended temperature level.

### Temperature ranges and settings for the cooking sensor function

Cooking function	Temperature range °F (°C)	Suitable for, e.g.	Tips
Heating / keeping warm	140 - 160 (60 - 70)	soups, punch	<ul style="list-style-type: none"> <li>■ Portioned frozen products, such as spinach.</li> <li>■ Place the frozen product in the cookware.</li> <li>■ Add the volume of water specified by the manufacturer.</li> <li>■ Place a lid on the cookware and set the temperature to 160°F (70°C).</li> <li>■ Stir occasionally.</li> </ul>
Poaching	175 - 195 (80 - 90)	rice, milk	<ul style="list-style-type: none"> <li>■ This function is suitable for cooking food at low temperatures and for thickening sauces and stews.</li> <li>■ Set the temperature to 195°F (90°C).</li> </ul>
Boiling	195 - 212 (90 - 100)	pasta, vegetables	<ul style="list-style-type: none"> <li>■ You can use this function to boil water with the lid on without it boiling over.</li> <li>■ The temperature control allows for efficient cooking.</li> <li>■ Set the temperature to 212°F (100°C).</li> </ul>
Cooking in a pressure cooker	230 - 250 (110 - 120)	chicken, stew	<ul style="list-style-type: none"> <li>■ Follow the manufacturer's recommendations.</li> <li>■ After the audible signal sounds, continue cooking for the recommended time.</li> <li>■ Set the temperature to 240°F (115°C).</li> </ul>

Cooking function	Temperature range °F (°C)	Suitable for, e.g.	Tips
Frying with a large amount of oil in a pot	340 - 355 (170 - 180)	doughnuts, dumplings	<ul style="list-style-type: none"> <li>■ Heat the oil with the lid on.</li> <li>■ Remove the lid after the audible signal and add the food, unless there are different instructions in the cooking charts.</li> <li>■ Set the temperature to 340°F (170°C).</li> </ul>

### Setting the boiling point

The point at which water starts to boil depends on the height of your home above sea level. If the water is boiling too vigorously or not vigorously enough, you can set the boiling point.

1. Select the basic setting  $\epsilon 5$ .  
→ "Basic settings", Page 32

2. The boiling point is set to setting 3 by default. If your home is at an elevation between 650 and 1300 ft. (200 - 400 m) above sea level, there is no need to change the boiling point. If not, choose the correct setting from the following table according to your altitude.

Altitude ft. (m)	Basic setting $\epsilon 5$
0 - 330 (0 - 100)	1
330 - 650 (100 - 200)	2
650 - 1300 (200 - 400)	3 <sup>1</sup>
1300 - 2000 (400 - 600)	4
2000 - 2600 (600 - 800)	5
2600 - 3300 (800 - 1000)	6
3300 - 4000 (1000 - 1200)	7
4000 - 4600 (1200 - 1400)	8
Above 4600 (1400)	9

<sup>1</sup> Factory setting (may vary according to model)

**Note:** The temperature level 212°F (100°C) is sufficient for efficient boiling, even if the water does not boil very quickly. However, you can change the boiling point. For example, if you want it to boil more quickly, you can select a lower altitude.

### Setting the cooking sensor function

**Requirement:** The cooktop is turned on.

1. Attach the wireless cooking sensor to the cookware.  
→ "Wireless cooking sensor", Page 29
2. Place a pot filled with sufficient liquid on the cooking zone and cover it with a lid.
3. Select the cooking zone with the twist knob.
  - ✓  $\square \square$  lights up in the cooking zone display.
4. Press  $\epsilon 5$ .
  - ✓ A signal sounds.
  - ✓  $\epsilon 5$  lights up in the cooking zone display.

5. Press the  $\epsilon 5$  symbol on the wireless cooking sensor.

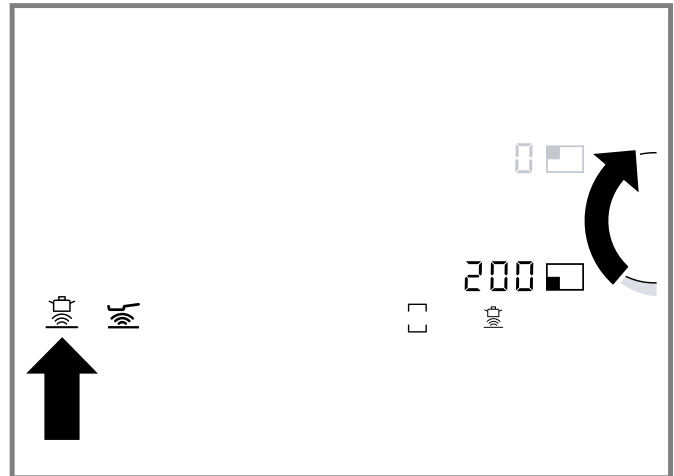

- ✓ Once the cooking sensor has been detected, the default temperature of 200°F (95°C) lights up in the cooking zone display.
6. Set the desired temperature with the twist knob. The temperature can be changed in increments of 5 or 10°F (approx. 5°C).
  7. The cooking zone starts to heat up. The cooking zone display shows the heating progress from  $\_$  to  $\bar{\_}$  and flashes alternately with the set cooking temperature.

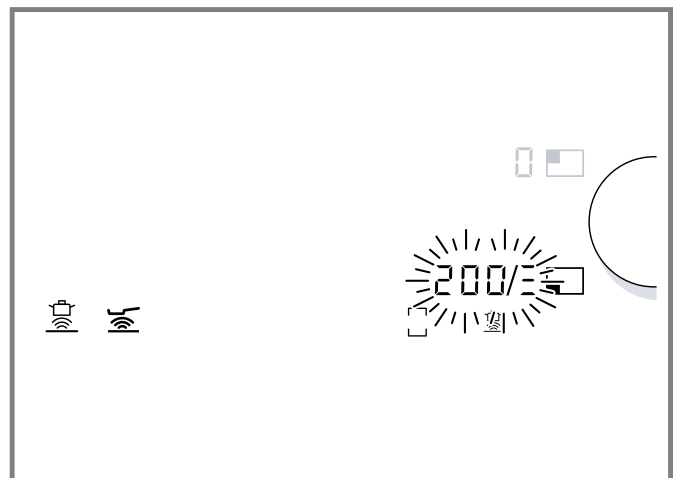





- ✓ Once the set cooking temperature is reached, a signal sounds and the heat-up indicator goes out. The cooking temperature is displayed.
8. Remove the lid after the signal tone and add the food. Keep the lid closed during the cooking process.
  9. You can also call up the cooking sensor functions via the wireless cooking sensor:
    - Place the cookware and press the  $\epsilon 5$  symbol on the wireless cooking sensor.
    - Select the cooking zone with the twist knob. When the cooking sensor function is ready,  $\square \square$  lights up in the cooking zone display.
    - Set the desired temperature with the twist knob.



**Note:** When frying with a large amount of oil, do not cover the pot with a lid.



### Turning the cooking sensor function off

- ▶ You can deactivate the cooking sensor functions in different ways:



























- Select the cooking zone and press .
- Select the cooking zone and set the temperature to .
- Press the  symbol on the wireless cooking sensor.
- ✓ A signal sounds and  goes out.

### Cooking charts for the cooking assistance functions









The following charts provide a selection of dishes and are sorted according to foods. Temperature and cooking time depend on the quantity, condition and quality of the foods.

Touch key	Cooking assistance function
	Frying sensor function for frying pans
	Cooking sensor function









#### Meat

Food	Function	Temperature °F (°C)	Total cooking time from sound signal
<b>Frying with a little oil</b>			
Escalope, plain		4	6-10
Escalope, breaded		4	6-10
Fillet		4	6-10
Chops		3	10-15
Cordon bleu		4	10-15
Viennese schnitzel		4	10-15
Steak, rare, 1¼" (3 cm) thick		5	6-8
Steak, medium, 1¼" (3 cm) thick		5	8-12
Steak, well done, 1¼" (3 cm) thick		4	8-12
Poultry breast, ¾" (2 cm) thick		3	10-20
Meat cut into strips		4	7-12
Gyros		4	7-12
Bacon		4	5-8
Ground meat		4	6-10
Hamburgers, ½" (1.5 cm) thick		3	6-15
Rissoles, ¾" (2 cm) thick		3	10-20
Filled rissoles		3	10-20
Boiled sausages		3	8-20
Raw sausages		3	8-20
<b>Poaching</b>			
Sausages		195 (90)	10-20
<b>Boiling</b>			
Meatballs		212 (100)	20-30
Stewing poultry		212 (100)	60-90
Viennese boiled beef		212 (100)	60-90
<b>Cooking with a pressure cooker</b>			
Stewing poultry		250 (115)	15-25
Viennese boiled beef		250 (115)	15-25
<b>Deep-fat frying</b>			
Deep-fat frying chicken portions		340 (170)	10-15
Deep-fat frying meatballs		340 (170)	10-15















## Fish











Food	Function	Temperature °F (°C)	Total cooking time from sound signal
<b>Frying with little oil</b>			
Fish fillet, plain		4	10-20
Fish fillet, breaded		3	10-20
Scampi		4	4-8
Shrimp		4	4-8
Fried whole fish		3	10-20
<b>Poaching</b>			
Braised fish		195 (90)	15-20
<b>Deep-fat frying</b>			
Deep-fat frying fish in beer batter		340 (170)	340 (170)
Deep-fat frying breaded fish		340 (170)	10-15

## Egg dishes









Food	Function	Temperature °F (°C)	Total cooking time from sound signal
<b>Frying with little oil</b>			
Fried eggs in butter		2	2-6
Fried eggs		4	2-6
Scrambled eggs		2	4-9
Omelettes		2	3-6
Crêpes		5	1,5-2,5
French toast		3	4-8
Shredded raisin pancake		3	10-15
<b>Boiling</b>			
Boiled eggs		212 (100)	5-10

## Vegetables and legumes







Food	Function	Temperature °F (°C)	Total cooking time from sound signal
<b>Frying with a little oil</b>			
Garlic		2	2-10
Onions, sautéed		2	2-10
Onion rings		3	5-10
Zucchini		3	4-12
Eggplant		3	4-12
Peppers		3	4-15
Frying green asparagus		3	4-15
Mushrooms		4	10-15
Sautéing vegetables in oil		1	10-20
Glazed vegetables		3	6-10
<b>Boiling</b>			
Broccoli		212 (100)	10-20
Cauliflower		212 (100)	10-20
Brussels sprouts		212 (100)	30-40
Green beans		212 (100)	15-30
Chickpeas		212 (100)	60-90

Food	Function	Temperature °F (°C)	Total cooking time from sound signal
Peas		212 (100)	15-20
Lentils		212 (100)	45-60
<b>Cooking in a pressure cooker</b>			
Vegetables in a pressure cooker		250 (115)	3-6
Chickpeas in a pressure cooker		250 (115)	25-35
White beans in a pressure cooker		250 (115)	25-35
Lentils in a pressure cooker		250 (115)	10-20
<b>Deep-fat frying</b>			
Deep-fat frying breaded vegetables		340 (170)	4-8
Deep-fat frying vegetables in beer batter		340 (170)	4-8
Deep-fat frying breaded mushrooms		340 (170)	4-8
Deep-fat frying mushrooms in beer batter		340 (170)	4-8

### Potatoes



Food	Function	Temperature °F (°C)	Total cooking time from sound signal
<b>Frying with a little oil</b>			
Fried potatoes, made from unpeeled boiled potatoes		5	6-12
French fries, made from raw potatoes		4	15-25
Potato pancakes		5	2,5-3,5
Swiss rösti		2	50-55
Glazed potatoes		3	10-15
<b>Poaching</b>			
Cooking potato dumplings		185 (85)	30-40
<b>Boiling</b>			
Boiling potatoes		212 (100)	30-45
<b>Cooking in a pressure cooker</b>			
Potatoes in a pressure cooker		250 (115)	10-20

### Pasta and cereals





Food	Function	Temperature °F (°C)	Total cooking time from sound signal
<b>Poaching</b>			
Rice		195 (90)	25-35
Polenta		185 (85)	3-8
Semolina pudding		185 (85)	5-10
<b>Boiling</b>			
Pasta		212 (100)	7-10
Dumplings		212 (100)	6-15
<b>Cooking in a pressure cooker</b>			
Rice in a pressure cooker		250 (115)	5-8

### Soups







Food	Function	Temperature °F (°C)	Total cooking time from sound signal
<b>Poaching</b>			
Instant creamy soups		195 (90)	10-15
<b>Hervir</b>			

Food	Function	Temperature °F (°C)	Total cooking time from sound signal
Home-made broths		212 (100)	60-90
Instant soups		212 (100)	5-10
<b>Cooking in a pressure cooker</b>			
Home-made broths in a pressure cooker		250 (115)	20-30













**Sauces**













Food	Function	Temperature °F (°C)	Total cooking time from sound signal
<b>Frying with a little oil</b>			
Tomato sauce with vegetables		1	25-35
Béchamel sauce		1	10-20
Cheese sauce		1	10-20
Reducing sauces		1	25-35
Sweet sauces		1	15-25

**Desserts**

Food	Function	Temperature °F (°C)	Total cooking time from sound signal
<b>Poaching</b>			
Rice pudding		185 (85)	40-50
Porridge		185 (85)	10-15
Chocolate pudding		185 (85)	3-5
<b>Boiling</b>			
Compote		212 (100)	15-25
<b>Deep-fat frying</b>			
Deep-fat frying jam-filled doughnuts		320 (160)	5-10
Deep-fat frying ring doughnuts		320 (160)	5-10
Deep-fat frying buñuelos		320 (160)	320 (160)

**Frozen products**

Food	Function	Temperature °F (°C)	Total cooking time from sound signal
<b>Frying with a little oil</b>			
Escalope		4	15-20
Cordon bleu		4	10-30
Poultry breast		4	10-30
Chicken nuggets		4	10-15
Gyros		4	10-15
Kebab		4	10-15
Fish fillet, plain		3	10-20
Fish fillet, breaded		3	10-20
Fish sticks		4	8-12
Frying French fries		5	4-6
Stir-fries		3	6-10
Spring rolls		4	10-30
Camembert		3	10-15
<b>Keeping warm, heating</b>			

Food	Function	Temperature °F (°C)	Total cooking time from sound signal
Vegetables in cream sauce		160 (70)	160 (70)
<b>Boiling</b>			
Green beans, frozen		212 (100)	15-30
<b>Deep-fat frying</b>			
Deep-fat frying French fries		355 (180)	4-8
<b>Miscellaneous</b>			
Food	Function	Temperature °F (°C)	Total cooking time from sound signal
<b>Frying with a little oil</b>			
Camembert		3	6-10
Croutons		3	6-10
Dried ready meals		1	5-10
Toasting almonds		4	3-15
Toasting nuts		4	3-15
Toasting pine nuts		4	3-15
<b>Keeping warm, heating</b>			
Heating goulash soup		160 (70)	10-20
Heating mulled wine		160 (70)	5-15
<b>Poaching</b>			
Heating milk		185 (85)	3-10

### Teppan Yaki for the flexible cooking zone

The Teppan Yaki accessories are ideal for the flexible cooking zone and are optimal cookware for using the frying sensor function.











With Teppan Yaki  you can cook meat, fish, seafood, vegetables, desserts and bread with very little oil, easily and healthily. The Teppan Yaki adapts perfectly to the flexible cooking zone. Direct contact with the plate and



uniform heat transfer make it possible to retain the consistency, color and succulence of the food when searing and browning.

The following table shows a selection of dishes and is arranged by food type. The temperature and the cooking time depend on the amount, the condition and the quality of the food.





**Note:** Set up the flexible cooking zone as a joined cooking zone to ensure the function is activated correctly.

### Meat









Food	Cookware	Frying sensor level	Total frying time after the signal (min)
Escalope, plain		4	6 - 10
Fillet		4	4
Chops		3	3
Steak, rare, 1¼" (3 cm) thick		5	5
Steak, medium, 1¼" (3 cm) thick		5	8 - 12
Steak, well done, 1¼" (3 cm) thick		4	4
Poultry breast, ¾ (2 cm) thick		3	10 - 20
Bacon		3	3
Hamburgers		3	6 - 15
Boiled sausages		4	8 - 20
Raw sausages		4	8 - 20

Food	Cookware	Frying sensor level	Total frying time after the signal (min)
Gyros		4	7 - 12
Ground meat		4	6 - 10



**Fish and seafood**

Food	Cookware	Frying sensor level	Total frying time after the signal (min)
Fish fillet, plain		4	10 - 20
Scampi		4	4 - 8
Prawns		4	4 - 8
Fried fish, whole		3	15 - 30







**Verduras****Vegetables**

Food	Cookware	Frying sensor level	Total frying time after the signal (min)
Zucchini		3	4 - 12
Eggplant		3	4 - 12
Peppers		3	4 - 15
Frying green asparagus		3	4 - 15
Mushrooms		4	10 - 15
Garlic		2	2 - 10
Sweating onions		2	2 - 10
Glazing vegetables		3	6 - 10



**Potatoes**



Food	Cookware	Frying sensor level	Total frying time after the signal (min)
Fried potatoes, made from unpeeled boiled potatoes		5	6 - 12
Potato pancakes		5	2,5 - 3,5
Glazed potatoes		3	10 - 15

**Egg dishes**

Food	Cookware	Frying sensor level	Total frying time after the signal (min)
Fried eggs in butter		2	2 - 6
Fried eggs in oil		4	2 - 6
Scrambled eggs		2	4 - 9
Omelettes		2	3 - 6
Pancakes		5	1,5 - 2,5
French toast		3	4 - 8
Shredded raisin pancake		3	10 - 15

**Miscellaneous**

Food	Cookware	Frying sensor level	Total frying time after the signal (min)
Toasting		4	4 - 6
Croûtons		3	6 - 10
Toasting almonds		4	4

Food	Cookware	Frying sensor level	Total frying time after the signal (min)
Toasting nuts		4	3 - 15
Toasting pine nuts		4	3 - 15

## 7.12 Wireless cooking sensor

Before you use the cooking functions for the first time, establish the connection between the wireless cooking sensor and the control panel.

### Preparing and maintaining the wireless cooking sensor

This section provides you with the following information:

- Attaching the silicone patch
- Using the wireless cooking sensor
- Cleaning
- Replacing the battery

You can retroactively purchase the silicone patch and cooking sensor from specialist retailers, our technical customer service or our official website. When doing so, quote the relevant reference number:

00577921	Set of 5 silicone patches
CA060300	Cooking sensor and set of 5 silicone patches

### Attaching the silicone patch

The silicone patch secures the cooking sensor to the cookware. If you are using an item of cookware with the cooking functions for the first time, attach the silicone patch to the cookware. Note:

1. The part of the pan to which the patch is to be adhered must be free of grease. Clean the cookware, dry it thoroughly and wipe the area where the patch is to be adhered using alcohol, for example.
2. Remove the protective film from the silicone patch. Adhere the silicone patch in the correct place on the outside of the pan using the supplied template as a guide.

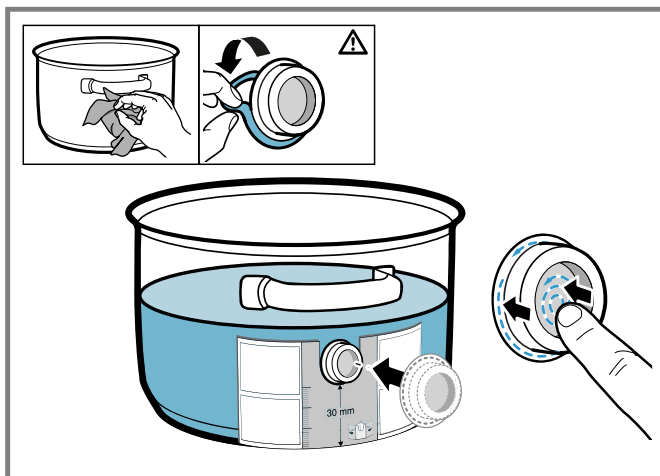

3. Press down all over the surface of the silicone patch, including in the center.

The adhesive requires 1 hour to fully cure. Do not use or clean the cookware during this time.

### Notes

- The cookware with the silicone patch must not be left to soak for long periods in soapy water.
- If the silicone patch comes loose, use a new one.

### Attaching the wireless cooking sensor

Place the cooking sensor squarely onto the silicone patch.

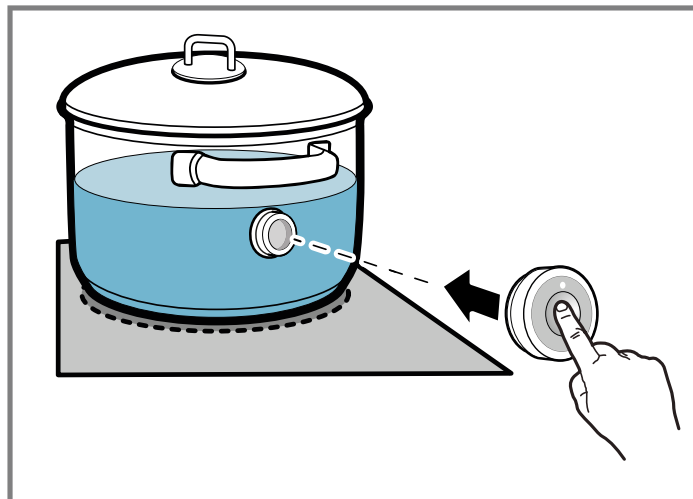





### Notes

- Ensure that the silicone patch is completely dry before attaching the cooking sensor.
- Position the cookware in such a way that the cooking sensor is pointing towards the outer side of the cooktop.
- To prevent overheating, do not align the cooking sensor to any other hot cookware.
- When you are not using the cooking sensor, remove it from the cookware and store it in a clean, secure location, away from any heat sources.
- You can use up to three cooking sensors at the same time.

### Connecting the wireless cooking sensor to the control panel

The cooking functions are available as soon as the wireless cooking sensor has been connected to the control panel correctly.

1. Select the basic setting  $\epsilon 5$ .  
→ "Basic settings", Page 32
- ✓  lights up white.
2. Press .
- ✓ A signal sounds.
- ✓  lights up orange.
3. The cooking zone indicators light up white and the cooking sensor indicators on the cooking zones flash.
4. Briefly touch the  symbol on the wireless cooking sensor within the next 30 seconds.

After a few seconds, the status of the connection between the cooking sensor and the control panel is indicated.

- |                             |   |
|-----------------------------|---|
| <p>Detection successful</p> | <ul style="list-style-type: none"> <li>■ The wireless temperature sensor is detected within a few seconds.</li> <li>■ Three short beeps sound and the  symbol changes from orange to white.</li> </ul> |
|-----------------------------|---|



- The cooking sensor indicators on the cooking zones go out.

Detection failed



- Five beeps sound.
- The  symbol changes immediately from orange to white.
- The cooking sensor indicators on the cooking zones go out.

**Note**

The connection may not be established correctly for the following reasons:

- Bluetooth® communication error.
  - You have not pressed the  symbol on the cooking sensor within 30 seconds after selecting the cooking zone.
  - The battery in the wireless cooking sensor is almost flat.
5. If the connection has failed, reset the wireless cooking sensor and repeat the connection procedure.  
→ "Resetting the wireless cooking sensor", Page 30
  6. If there are problems with the connection due to a transmission error, repeat the connection procedure.
  7. If no connection can be established, inform Customer Service.

**Resetting the wireless cooking sensor**

1. Press and hold  for 8 to 10 seconds.
  - ✓ While you keep the touch key pressed, the LED indicator on the wireless cooking sensor lights up three times.
2. When the LED lights up for the third time, release the  touch key.
  - ✓ The reset procedure starts.
  - ✓ When the LED goes out, the wireless cooking sensor has been reset.
3. Repeat the connection process.  
→ "Connecting the wireless cooking sensor to the control panel", Page 29

**Cleaning**

Do not clean the wireless cooking sensor in the dishwasher.

**Cooking sensor**

Clean with a damp cloth. Do not place in the dishwasher and do not get it wet. When you are not using the cooking sensor, remove it from the cookware and store it in a clean, secure location, away from any heat sources.

**Silicone patch**

Clean and dry before attaching the cooking sensor. Suitable for dishwashers.

**Note:** The cookware with the silicone patch must not be left to soak for long periods in soapy water.

**Cooking sensor window**

The cooking sensor window must always be clean and dry. Note:

- Remove dirt and oil splatters regularly.
- For cleaning, use a cloth or q-tips and window cleaning solution.

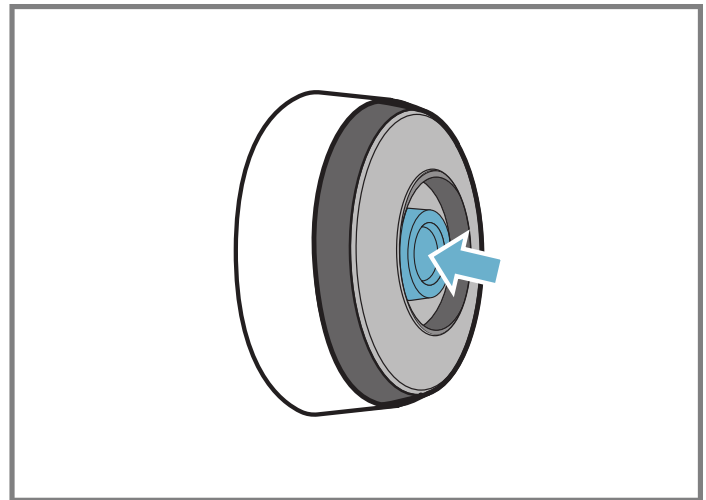

**Notes**

- Do not use hard or rough objects such as bristle brushes or scouring pads to clean the cooktop, and do not use scouring agents.
- Do not touch the window of the wireless cooking sensor with your fingers; this will soil or scratch it.

**Replacing the battery**

If the cooking sensor does not light up when you touch the symbol, the battery has discharged. Replacing the battery:

1. Remove the silicone cover from the lower section of the cooking sensor casing and remove both screws using a screwdriver.

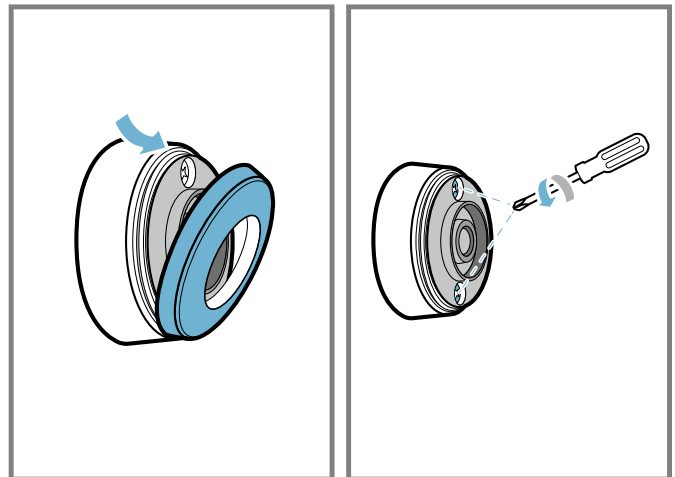

2. Open the cap on the cooking sensor. Remove the battery from the lower section of the casing and insert a new battery. In doing so, pay attention to the correct alignment of the battery terminals.

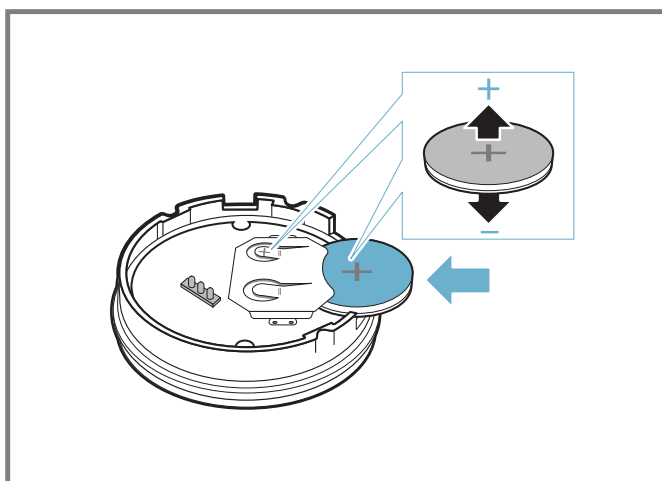
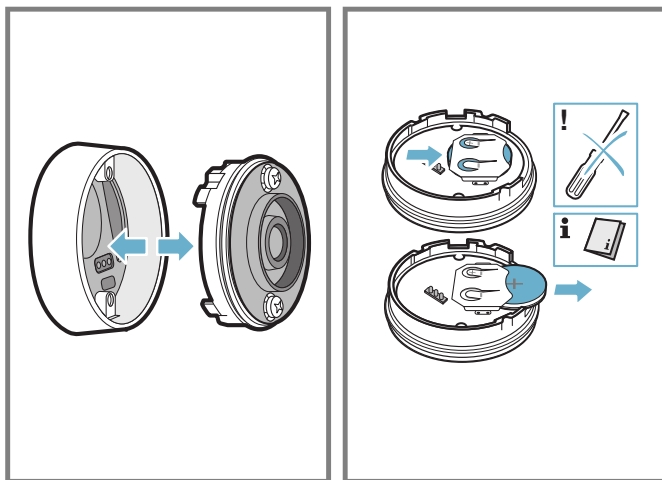

**Note:** Do not use any metal objects to remove the battery. Do not touch the battery terminals.

3. Close the cap on the cooking sensor. The indentations for the screws on the cap must be aligned with the indentations on the lower section of the casing. Tighten the screws with a screwdriver.

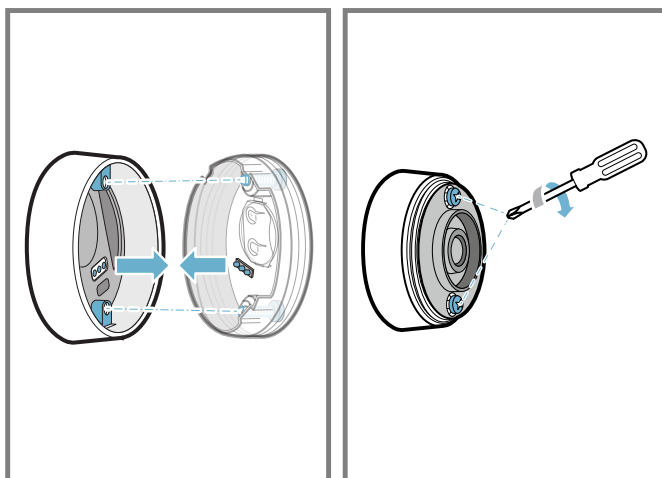

4. Reattach the silicone cover back to the lower section of the cooking sensor casing.

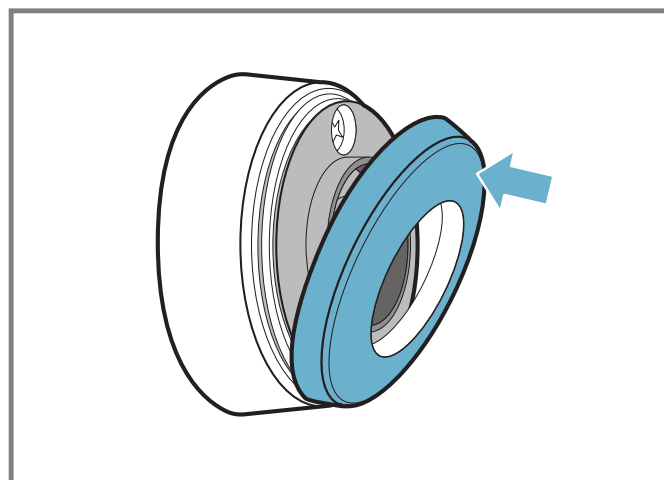

**Note:** Use only high-quality CR2032 batteries in order to guarantee a long service life.

### Declaration of Conformity

BSH Home Appliances Corporation hereby declares that the appliance with wireless cooking sensor function meets the basic requirements and other relevant provisions of the Directive 2014/53/EU.

A detailed Declaration of Conformity in accordance with Directive RED can be found at [www.gaggenau.com](http://www.gaggenau.com) on the product page for your appliance under "Additional documents."

The logos and the Bluetooth® brand are registered trademarks and property of Bluetooth SIG, Inc. These trademarks are used by BSH Home Appliances Corporation under licence. All other marks and trade names are the property of the respective companies.

### 7.13 Panel lock

You can use the panel lock to prevent the cooktop from being turned on accidentally.

#### Activating the panel lock

**Requirement:** The cooktop is turned off.

- ▶ Remove the twist knob from the cooktop.
- ✓ A signal sounds.
- ✓  lights up for 10 seconds.
- ✓ The control panel is locked.

#### Deactivating the panel lock

- ▶ Place the twist knob onto the twist pad.
- ✓ The control panel is unlocked.

**Note:** Removing the twist knob when the cooktop is switched on initially activates the display cleaning protection. If you do not place the twist knob back on after 10 minutes, the cooktop switches itself off and the panel lock is activated.

### 7.14 Wipe protection

With this function you can avoid changing the settings while cleaning the control panel during cooking. This function does not lock the main switch. You can turn the cooktop off at any time.

### Activating the display cleaning protection

With this function, you can clean the control panel while the cooktop is switched on, without accidentally changing any settings.

- ▶ Remove the twist knob from the cooktop.
- ✓ A signal sounds.
- ✓  and the cooktop settings are blinking.
- ✓ The heating process is interrupted.
- ✓ If a timer is running, it will be paused.
- ✓ The control panel is locked for 10 minutes.

**Note:** If you do not place the twist knob back on after 10 minutes, the cooktop switches itself off and the panel lock is activated.

### Deactivating the display cleaning protection

- ▶ Put the twist knob back onto the twist pad within 10 minutes.
- ✓ The control panel is unlocked. Operation is resumed.

## 7.15 Basic settings

You can configure the basic settings for your appliance to meet your needs.

### Basic settings overview

Here you can find an overview of the basic settings and the preset factory settings.

Display	Function
c1	Signal tones ON - All signals are switched on. <sup>1</sup> OFF - Most of the signals are switched off.
c2	Time for setting a cooking zone after selection 5 - The cooking zone remains selected for 5 seconds. 10 - The cooking zone remains selected for 10 seconds. <sup>1</sup> 15 - The cooking zone remains selected for 15 seconds. OFF - Unlimited: The last selected cooking zone remains selected. You can adjust the settings without having to select it again.
c3	Power management function. Limiting the total power of the cooktop. The available settings depend on the maximum power of the cooktop. 0 - Deactivated <sup>1, 2</sup> 1 - 1.000 W minimum power 1.5 - 1.500 W ... 3 - 3.000 W recommended for 13 A 3.5 - 3.500 W recommended for 16 A 4 - 4.000 W 4.5 - 4.500 W recommended for 20 A ... 9 or 9.5 - Maximum power of the cooktop <sup>2</sup>
c4	Restore factory settings OFF - Keep personal settings. <sup>1</sup> ON - Restore factory settings.

<sup>1</sup> Factory setting (may vary according to model)

<sup>2</sup> The cooktop's maximum power output is shown on the rating plate

Display	Function
c5	Cooking sensor Connect the wireless cooking sensor to the cooktop. Set according to height above sea level: ■ 1 - 2: Decrease 3: Default setting <sup>1</sup> 4 - 9: Increase
c7	Results for suitability test for cookware 0 - Not suitable. 1 - Not ideal. 2 - Suitable.
c9	Home Connect™ → "Home Connect™", Page 33

<sup>1</sup> Factory setting (may vary according to model)

<sup>2</sup> The cooktop's maximum power output is shown on the rating plate

### Changing the basic settings

**Requirement:** The cooktop is turned off.

1. Turn on the cooktop.
  2. Within the next 10 seconds, press .
- The first four displays provide the product information. To call up the individual displays, turn the twist knob.

Product information	Display
Customer Support index (CI)	01
Production number	Fd
Production number 1	95.
Production number 2	0.5

3. Press  again to access the basic settings.

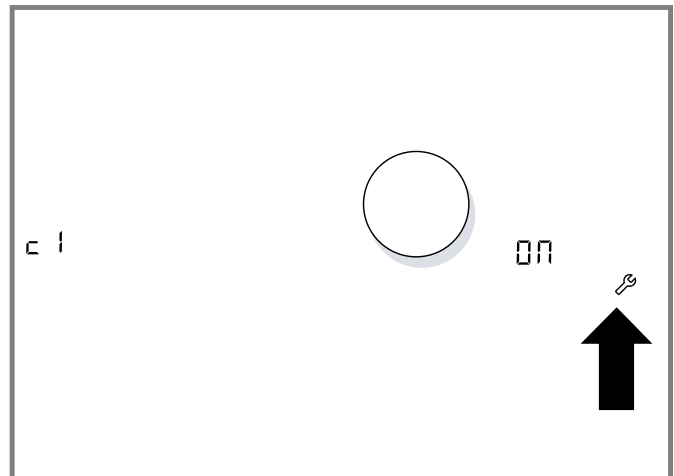

4. Press  repeatedly until the required basic setting is displayed.

5. Select the required value with the twist knob.

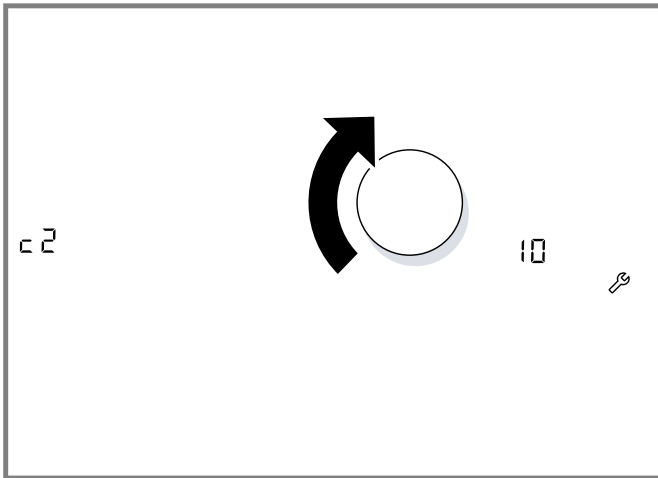

6. Press  for at least 4 seconds.  
✓ The setting is saved.

**Tip:** Press  to leave the basic settings and turn off the cooktop.

### Changing the basic settings

**Requirement:** The cooktop is turned off.

1. Turn on the cooktop.
2. Within the next 10 seconds, press .

The first four displays provide the product information. To call up the individual displays, turn the twist knob.

Product information	Display
Customer Support index (CI)	01
Production number	Fd
Production number 1	95.
Production number 2	05

3. Press  again to access the basic settings.

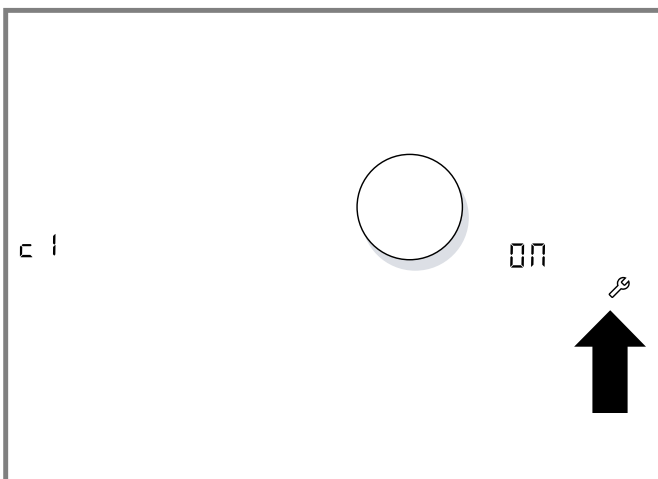

4. Press  repeatedly until the required basic setting is displayed.

5. Select the required value with the twist knob.

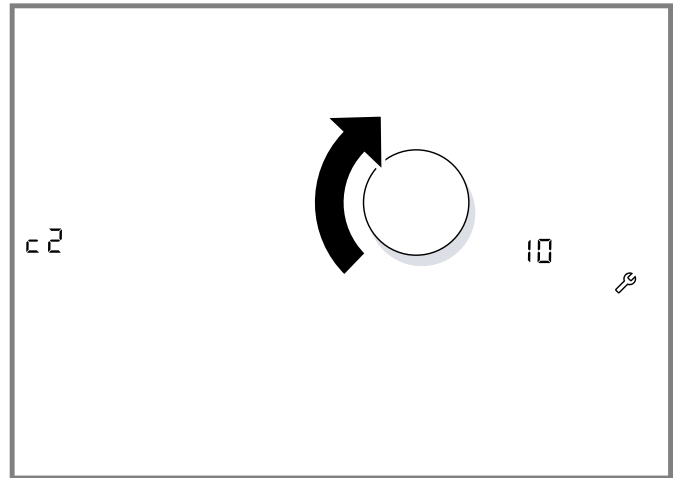

6. Press  for at least 4 seconds.  
✓ The setting is saved.

**Tip:** Press  to leave the basic settings and turn off the cooktop.

### 7.16 Power limitation

You can use the PowerManager function to set the total power of the cooktop.

The cooktop is set at the factory; the cooktop's maximum power is shown on the rating label. You can use this function to adjust the configuration to the requirements of each electrical installation.

In order to not exceed this set value, the cooktop automatically distributes the available power as needed between the cooking zones that are switched on.

While this function is activated, the output of each cooking zone may temporarily fall below the nominal value. In order to not exceed this set value, the cooktop automatically distributes the available power as needed between the cooking zones that are switched on. The appliance regulates and selects the highest power level automatically.

For more information, go to  
→ "Basic settings", Page 32

## 8 Home Connect™

This appliance is network-capable. Connecting your appliance to a mobile device lets you control its functions via the Home Connect™ app, adjust its basic settings and monitor its operating status.

The Home Connect™ services are not available in every country. The availability of the Home Connect™ function depends on the availability of Home Connect™ services in your country. You can find information on this at: [www.home-connect.com](http://www.home-connect.com).

The Home Connect™ app guides you through the entire registration process. Follow the instructions in the Home Connect™ app to implement the settings.

#### Tips

- Consult the Home Connect™ documents supplied.
- Follow the instructions in the Home Connect™ app as well.

**Notes**

- Also note the safety information in this instruction manual and ensure that it is also observed when operating the appliance using the Home Connect™ app.
- Cooktops are not designed to be left unattended. Always monitor the cooking process.
- Operating the appliance on the appliance itself always takes priority. It is not possible to operate the appliance using the Home Connect™ app during this time.
- In networked standby mode, the appliance requires a maximum of 2 watts.

**8.1 Setting up Home Connect™**

**Requirements**

- The appliance is connected to the power supply and is switched on.
- You have a mobile device with a current version of the iOS or Android operating system, e.g. a smartphone.
- The mobile device and the appliance are within range of your home network's Wi-Fi signal.

**8.2 Overview of the Home Connect™ settings**

You can adjust the settings and network settings for Home Connect™ by going to your hob's basic settings.

Setting	Selection or display	Additional information
<i>H C 1/NET</i>	Network connection <i>OFF</i> – Not connected/disconnect network <i>001</i> – Connect automatically <i>002</i> – Connect manually <i>00</i> – Connected	Log the hob on in the WLAN home network (Wi-Fi) or disconnect from the network.
<i>H C 2/PRI</i>	Connecting to the app <i>OFF</i> – Not connected <i>00</i> – Connect	<i>H C 2/PRI</i> is only displayed if the hob is connected to the home network.
<i>H C 3/CON</i>	Connecting to the Wi-Fi <i>OFF</i> – Wireless module switched off <i>00</i> – Wireless module switched on	If Wi-Fi has been activated, you can use the Home Connect™ function. <i>H C 3/CON</i> is only displayed if the hob has been previously connected to a network.
<i>H C 4/FES</i>	Setting via the app <i>OFF</i> – Switched off <i>00</i> – Switched on <sup>1</sup>	If the setting is switched off, only the hob's operating statuses are displayed in the Home Connect™ app.
<i>H C 5/UPd</i>	Software update <i>dEF</i> – Update available and ready to install <i>005</i> – Start installation	<i>H C 5/UPd</i> is only displayed if a software update is available.
<i>H C 6/FEd</i>	Control remote access by customer service <i>OFF</i> – Not authorized <i>00</i> – Authorized	<i>H C 6/FEd</i> is only displayed if customer service is attempting to connect to the hob. Once you grant access, you can end this at any time.
<i>H C 7/SEF</i>	Display Wi-Fi signal strength <i>00</i> – Not connected to the WLAN home network (Wi-Fi) <i>1</i> – Signal strength 1 (poor) <i>2</i> – Signal strength 2 (moderate) <i>3</i> – Signal strength 3 (good)	<i>H C 7/SEF</i> is only displayed if there is a connection to the WLAN home network (Wi-Fi).

<sup>1</sup> Factory setting

1. Download the Home Connect™ app.



2. Open the Home Connect™ app and scan the following QR code.



3. Follow the instructions in the Home Connect™ app.



Setting	Selection or display	Additional information
<i>HC B/Set</i>	Connection to the Home Connect™ server <i>OFF</i> – Not connected <i>ON</i> – Connected	<i>HC B/Set</i> is only displayed if there is a connection to the WLAN home network (Wi-Fi).

<sup>1</sup> Factory setting

### 8.3 Changing settings via the Home Connect™ app



You can use the Home Connect™ app to change the settings for the cooking zones and send them to the cooktop.

#### Requirements

- The appliance is connected to the home network and to the Home Connect™ app.
- In order to set the hob via the app, the basic setting *HC4* must be switched on.
- The hob is switched on.

1. Select the setting in the Home Connect™ app and send it to the cooktop.

Follow the instructions in the Home Connect™ app.

2. If the setting was previously *ON*, two steps are required:
  - If  flashes, touch .
  - If the cooking zone display alternately flashes the old and new value, select the cooking zone.
3. If the setting was not previously *ON*, the old and new value alternately flash directly on the cooking zone display.
  - To accept the setting for the cooking zone, select the cooking zone.
4. To discard the setting, touch any other button on the cooktop.

### 8.4 Software update

Your appliance's software can be updated using the software update function, e.g. for the purposes of optimization, troubleshooting or security updates.

To do this, you must be a registered Home Connect™ user, have installed the app on your mobile device and be connected to the Home Connect™ server.

As soon as a software update is available, you are informed via the Home Connect™ app and can start the software update via the app. Once the update has been successfully downloaded, you can start installing it via the Home Connect™ app if you are in your WLAN home network (Wi-Fi). The Home Connect™ app informs you once the installation is successful.

#### Notes

- You can continue to use your appliance as normal while updates are downloading. Depending on your personal settings in the app, software updates can also be set to download automatically.
- We recommend that you install security updates as soon as possible.

### 8.5 Remote diagnostics

The Customer Service can access your appliance via Remote Diagnostics if you ask them to do so, if your appliance is connected to the Home Connect™ server and if Remote Diagnostics is available in the country where you are using the appliance.

**Tip:** Further information and details about the availability of Remote Diagnostics in your country can be found in the Service/Support section of your local website: [www.home-connect.com](http://www.home-connect.com).

### 8.6 Data Protection

Please see the information on data protection.

The first time your appliance is registered on a home network connected to the Internet, your appliance will transmit the following types of data to the Home Connect™ server (initial registration):

- Unique appliance identification (consisting of appliance codes as well as the MAC address of the installed Wi-Fi communication module).
- Security certificate of the Wi-Fi communication module (to ensure a secure data connection).
- The current software and hardware version of your appliance.
- Status of any previous reset to factory settings.

This initial registration prepares the Home Connect™ functions for use and is only required when you want to use the Home Connect™ functions for the first time.

**Note:** Please note that the Home Connect™ functions can be utilized only with the Home Connect™ app. Information on data protection can be called up in the Home Connect™ app.

### 8.7 Wi-Fi module

#### FCC/IC Statements

Model:	COM2
FCC ID:	2AHES-COM2
IC ID:	21152-COM2

The Home Connect™ Wi-Fi module is a communication device designed to provide communication between appliances and smart devices.

This module is integrated at the factory, under direct control of BSH Home Appliances Corporation, and is not user serviceable or upgradable. At least 7 $\frac{7}{8}$  inch (20 cm) separation distance should be maintained from device to user.

#### FCC COMPLIANCE STATEMENT

#### CAUTION

Changes or modifications not expressly approved could void your authority to use this equipment.



This device complies with Part 15 of the FCC Rules.

Operation is subject to the following two conditions:

- This device may not cause harmful interference, and
- This device must accept any interference received, including interference that may cause undesired operation.

## INDUSTRY CANADA STATEMENT

This device complies with Industry Canada license exempt RSS standard(s).

Operation is subject to the following two conditions:

- This device may not cause interference, and
- This device must accept any interference, including interference that may cause undesired operation of the device.

## 9 Hood Control

You can connect your appliance to a hood and, in this way, control the functions of your hood via the cooktop. If both appliances are Home Connect™ compatible, the easiest way to connect the appliances is in the Home Connect™ app. To do this, connect the two appliances to Home Connect™ and follow the instructions in the app. Alternatively, you have the following options for connecting the appliances together:

- Connecting the appliances directly.
- Connecting the appliances via your home network.

### Notes



- Make sure you follow the safety instructions in the Use and Care Manual for your hood and that these are complied with even when operating the appliance via the hood controls on the cooktop.
- If the appliance is being operated by means of the controls on the hood, this mode of operation always has priority. It is not possible to use the hood controls on the cooktop during this time.
- In networked standby mode, your appliance requires a maximum of 2 W.

### 9.1 Connecting appliances directly

Connect the appliance directly to your hood to control the hood via the cooktop. If you connect your cooktop directly to the hood, it cannot be connected to your home network as well and you will not be able to use Home Connect™.

**Note:** Note the information for connecting the cooktop in the Assembly Instructions for your hood.

**Requirement:** The hood is switched off.

1. Turn on the cooktop.
2. Touch  to enter the basic settings menu.
3. Press  repeatedly until you reach the setting  $cE$ .
  - ✓  $FFF$  lights up on the cooking zone display.
4. Set the settings value to  $i$  using the twist knob.
  - ✓  $i$  is blinking on the cooking zone display.
5. Within 2 minutes, initiate the connection process on the hood. Refer to the operating instructions of your hood.
  - ✓ When the connection is completed  $FF$  lights up on the cooking zone display.
  - ✓ The hood control icons light up on the control panel.
6. Exit the basic settings.

**Note:** You can change the settings anytime in the basic settings menu.



### 9.2 Connecting appliances via your home network (Wi-Fi)

If the appliances are connected to each other via your home network, you can operate the hood via the cooktop controls or with Home Connect™.

**Note:** The appliances can only be connected when both are connected to the home network and are simultaneously engaged in connecting. If the time allowed for connecting has already expired for one of the two appliances, start the connection process again.

#### Requirements



- Your router has a WPS button. You will find information about this in the manual for your router.
- The hood is connected to the same home network (Wi-Fi).

1. Turn on the cooktop.
2. Touch  to enter the basic settings menu.
3. Press  repeatedly until you reach the setting  $cE$ .
  - ✓  $FFF$  lights up on the cooking zone display.
4. Set the settings value to  $i$  using the twist knob.
  - ✓  $i$  is blinking on the cooking zone display.
5. Press the WPS button on the router within the next 2 minutes.
  - ✓ The cooktop is connected to your home network.  $z$  lights up on the cooking zone display.
6. Initiate the connection process on the hood.
  - ✓ When the connection is completed  $FF$  lights up on the cooking zone display.
  - ✓ The hood control icons light up on the control panel.

### 9.3 Resetting the connection

If you have problems connecting your appliance to your home network (Wi-Fi) or if you want to log your appliance onto a different home network (Wi-Fi), you can reset the Home Connect™ settings.

**Note:** If you reset the Home Connect™ settings, the connection to any hood will also be terminated.

1. Turn on the cooktop.
2. Touch  to enter the basic settings menu.
3. Press  repeatedly until you reach the setting  $cE$ .
4. Set the settings value to  $FFF$  using the twist knob.

### 9.4 Controlling the hood via the cooktop



In the basic settings menu, you can configure what the hood should do when the cooktop or individual cooking zones are switched on or off.

You can select other settings using the control panel.

#### Setting the fan

1. Touch .
2. Turn the twist knob clockwise or anti-clockwise to select the fan level.

The following settings are possible:

	Fan off
	Automatic mode The fan starts automatically when steam is detected.

1, 2, 3	Fan level intensity: Low, medium, high
P	PowerBoost function
3	Interval mode
f	Fan run-on The fan runs on after the cooktop has been turned off.

### Turning off the fan

1. Touch .

2. Turn the twist knob until  lights up.

- ✓ Once the cooktop and hood have been switched off,  may still be faintly visible.

### Setting the hood lighting

You can switch the hood light on and off via the control panel of the cooktop.

- ▶ Press .

**Note:** Depending on the basic settings you have selected, the light will automatically be switched on or off when the cooktop is switched on or off.

## 9.5 Overview of the hood control settings

You can adjust the cooktop based hood controls to suit your requirements at any time.

**Note:** The settings will only be displayed if the appliance is connected to a hood. Some of these settings may not be available.

Setting	Values	Description
cE	<ul style="list-style-type: none"> <li>■ OFF - Not connected<sup>1</sup>/disconnect</li> <li>■ 1 - Start connection process</li> <li>■ 2 - Connected to home network (Wi-Fi)</li> <li>■ ON - Connected to hood</li> </ul>	Connection between cooktop and hood
cA	<ul style="list-style-type: none"> <li>■ OFF - Deactivated The hood must be switched on manually, if required.</li> <li>■ A - Switched on in automatic mode.<sup>1</sup> In automatic mode, the hood switches itself on when one of the cooking zones is switched on.</li> <li>■ 1 - Switched on in manual mode. The hood switches itself on at the lowest level when one of the cooking zones is switched on.</li> <li>■ 2 - Switched on in manual mode. The hood switches itself on at medium level when one of the cooking zones is switched on.</li> <li>■ 3 - Switched on in manual mode. The hood switches itself on at the highest level when one of the cooking zones is switched on.</li> </ul>	Automatic fan switch-on The display shows this setting only when the appliance has been connected to the hood.
cb	<ul style="list-style-type: none"> <li>■ OFF - Deactivated The fan switches off when the cooktop is turned off.</li> <li>■ A - Switched on in automatic mode<sup>1</sup></li> <li>■ ON - Switched on with standard delayed shut-off</li> <li>■ NO - No change to the settings</li> </ul>	Delay shut-off Setting for whether/how the fan is to run on after the cooktop is turned off. The display shows this setting only when the appliance has been connected to the hood.
cc	<ul style="list-style-type: none"> <li>■ 0 - Turned off<sup>1</sup></li> <li>■ 1 - Turned on The light turns on automatically when you turn on the cooktop.</li> </ul>	Turn light on automatically The display shows this setting only when the appliance has been connected to the hood.
cd	<ul style="list-style-type: none"> <li>■ OFF - Turned off<sup>1</sup></li> <li>■ ON - Turned on The light turns off automatically when you turn off the cooktop.</li> </ul>	Turn off the light automatically

<sup>1</sup> Factory setting (may vary according to model)

## 10 Cleaning and maintenance

To keep your appliance working efficiently for a long time, it is important to clean and maintain it carefully.

### 10.1 Cleaning agents

You can purchase suitable cleaners and glass scrapers from Customer Support or in our online shop [www.gaggenau.com/zz/store](http://www.gaggenau.com/zz/store).

#### Recommended cleaning agents

- Glass ceramic cooktop cleaner
- BonAmi®<sup>1</sup>
- Soft Scrub®<sup>1</sup> (without bleach)
- White vinegar

#### Unsuitable cleaning agents

- Glass cleaners which contain ammonia or chlorine bleach. These cleaners may damage or permanently stain the cooktop.
- Caustic cleaners such as Easy Off®<sup>1</sup>. These cleaners may stain the cooktop surface.
- Abrasive cleaners.
- Metal scouring pads and scrub sponges such as Scotch Brite®<sup>1</sup>. These cleaners may scratch the cooktop surface and/or leave metal marks.
- Soap-filled scouring pads such as SOS®<sup>1</sup>. These cleaners may scratch the cooktop surface.
- Powdery cleaners containing chlorine bleach. These cleaners may permanently stain the cooktop surface.
- Flammable cleaners such as lighter fluid or WD-40.

### 10.2 Cleaning the glass ceramic cooktop

#### WARNING

Clean Cooktop With Caution.

- ▶ If a wet sponge or cloth is used to wipe spills on a hot cooking area, be careful to avoid steam burn.
- ▶ Some cleaners can produce noxious fumes if applied to a hot surface.
- ▶ Do not clean the appliance while it is still hot.

#### CAUTION

Do not use any kind of cleaner on the glass while the surface is hot; use only the glass scraper. The resulting fumes can be hazardous to your health. Heating the cleaner can chemically attack and damage the surface.

#### Requirements

- The cooktop has cooled off.
  - Exception: Remove dry sugar, sugar syrup, milk and tomato products immediately.  
→ "Cleaning recommendations", Page 38
1. Wipe off spatters with a clean, damp sponge or a paper towel.
  2. Rinse and dry.
  3. If a smudge remains use white vinegar.
  4. Rinse and dry again.
  5. Apply a small amount of cooktop cleaner with a clean paper towel or cloth and let it dry.
  6. Buff the surface with a clean paper towel or cloth.

### 10.3 Cleaning the twist knob

#### NOTICE:

Incorrect cleaning may damage the twist knob.

- ▶ Do not use harsh or abrasive cleaning agents.
- ▶ Do not clean the twist knob in the dishwasher or using rinsing water.
- ▶ Clean the twist knob with lukewarm soapy water.

### 10.4 Cleaning recommendations

Follow these cleaning instructions for removing common soiling.

#### WARNING

The blade of the glass scraper is extremely sharp. You can cut yourself.

- ▶ Replace the blade immediately, when you see any imperfections.
- ▶ Follow the manufacturer's instructions.

#### NOTICE:

Diamond rings may scratch the ceramic cooktop surface.

- ▶ Take off any rings before you clean the ceramic cooktop surface.

Type of soil	Recommendation
<ul style="list-style-type: none"> <li>■ Dry sugar</li> <li>■ Sugar syrup</li> <li>■ Milk</li> <li>■ Tomato spills</li> <li>■ Melted plastic film or foil</li> </ul>	<p>REMOVE IMMEDIATELY. Failure to remove these substances immediately can permanently damage the ceramic cooktop surface.</p> <p>Remove the soil with the glass scraper while the cooktop surface is still hot.</p> <p>Use a new, sharp razor in the glass scraper.</p> <ul style="list-style-type: none"> <li>■ Remove the cookware and turn off the cooking zone.</li> <li>■ Put on an oven mitt.</li> <li>■ Hold the glass scraper at 30° angle and scrape off the soil. Be careful not to gouge or scratch the glass ceramic surface.</li> <li>■ Push the soil off the heated area.</li> <li>■ Let the surface cool.</li> <li>■ Remove the residue and apply glass ceramic cooktop cleaner.</li> </ul>
<ul style="list-style-type: none"> <li>■ Burned-on food soil</li> <li>■ Dark streaks</li> <li>■ Dark specks</li> </ul>	<ul style="list-style-type: none"> <li>■ Lay a damp paper towel or sponge on top of the soil for 30 minutes to soften the soil.</li> <li>■ Remove the soil with a plastic scrubber and glass ceramic cooktop cleaner or with the glass scraper.</li> <li>■ Rinse the cooktop surface and dry it.</li> </ul>

<sup>1</sup> These marks are registered trademarks of their respective owners. All other trademarks are trademarks of BSH Home Appliances Corporation or its affiliated companies.

Type of soil	Recommendation
Greasy spatters	<ul style="list-style-type: none"> <li>■ Remove grease with a soapy sponge or cloth.</li> <li>■ Rinse the cooktop surface thoroughly and dry it.</li> <li>■ Apply glass ceramic cooktop cleaner.</li> </ul>
Metal marks: iridescent stain	<p>Pans with aluminum, copper or stainless steel bases may leave marks.</p> <p>Treat metal marks immediately after the cooktop surface has cooled off. Failure to do so makes removal very difficult.</p> <ul style="list-style-type: none"> <li>■ Clean the cooktop surface with glass ceramic cooktop cleaner.</li> <li>■ If this does not remove the marks, clean the cooktop surface with a damp paper towel and a mild abrasive (Bon Ami®, Soft Scrub® without bleach).</li> <li>■ Rinse the cooktop surface and apply glass ceramic cooktop cleaner.</li> </ul>
Hard water spots	<p>Hot cooking liquids may drip or spill on the cooktop surface. The minerals in some water can be transferred onto the surface and cause stains.</p> <p>Remove boilovers and stains before using the cooktop again.</p> <ul style="list-style-type: none"> <li>■ Clean the cooktop surface with undiluted white vinegar.</li> <li>■ Rinse the cooktop surface and dry it.</li> <li>■ Apply glass ceramic cooktop cleaner.</li> </ul>
Surface scratches	<p>Small scratches are common and do not affect cooking. They become smoother and less noticeable with daily use of the glass ceramic cooktop cleaner.</p> <ul style="list-style-type: none"> <li>■ Apply glass ceramic cooktop cleaner before cooking. to remove sand-like grains and grit such as salt and seasoning.</li> <li>■ Scratches can be reduced by using pans with bases that are smooth, clean, and dry before use. Use recommended glass ceramic cooktop cleaner daily.</li> </ul>

## 10.5 Maintenance

This appliance requires no maintenance other than daily cleaning.

For best results, apply cooktop cleaning cream daily.

## 11 Troubleshooting

You can eliminate minor issues on your appliance yourself. Please read the information on eliminating issues before contacting Customer Service. This may avoid unnecessary repair costs.

### WARNING

Improper repairs are dangerous.

- ▶ Only authorized service providers should repair the appliance.
- ▶ If the appliance has an issue, call Customer Service.

### WARNING

Improper repairs are dangerous.

- ▶ Repairs to the appliance should only be performed by authorized service providers.
- ▶ Only original spare parts may be used to repair the appliance.

### WARNING

The cooktop switches off automatically and can no longer be operated. It may switch on unintentionally at a later point.

- ▶ Switch off the circuit breaker or fuse in the electrical panel.
- ▶ Call Customer Service.

Issue	Cause and troubleshooting
No display information	<p>The power supply has been disconnected.</p> <ul style="list-style-type: none"> <li>▶ Check whether the lighting in your kitchen or other appliances in the room are working.</li> </ul> <p>The appliance has not been connected as shown in the circuit diagram.</p> <ol style="list-style-type: none"> <li>1. Disconnect the appliance from the power supply.</li> <li>2. Make sure the appliance has been connected as shown in the circuit diagram.</li> </ol> <p>There is an electronics fault</p> <ul style="list-style-type: none"> <li>▶ If the fault cannot be eliminated, call Customer Service.</li> </ul>
All indicators are flashing	<p>The control panel is wet or an object is covering it.</p> <ul style="list-style-type: none"> <li>▶ Dry the control panel or remove the object.</li> </ul>
<i>F 2 / E7015</i>	<p>The electronics have overheated. The corresponding cooking zone has switched off.</p> <ol style="list-style-type: none"> <li>1. Wait until the electronics have cooled down sufficiently.</li> <li>2. Touch any control element.</li> </ol> <p>✓ When error message disappears, the electronics have cooled down sufficiently. You can continue to cook.</p>
<i>F 4 / E7015</i>	<p>The electronics have overheated. All cooking zones have switched off.</p> <ol style="list-style-type: none"> <li>1. Wait until the electronics have cooled down sufficiently.</li> <li>2. Touch any control element.</li> </ol> <p>✓ When error message disappears, the electronics have cooled down sufficiently. You can continue to cook.</p>
<i>F 2 / E8207</i>	<p>The electronics have overheated. The corresponding cooking zone has switched off.</p> <ol style="list-style-type: none"> <li>1. Wait until the electronics have cooled down sufficiently.</li> <li>2. Touch any control element.</li> </ol> <p>✓ When error message disappears, the electronics have cooled down sufficiently. You can continue to cook.</p>
<i>F 4 / E8208</i>	<p>The electronics have overheated. All cooking zones have switched off.</p> <ol style="list-style-type: none"> <li>1. Wait until the electronics have cooled down sufficiently.</li> <li>2. Touch any control element.</li> </ol> <p>✓ When error message disappears, the electronics have cooled down sufficiently. You can continue to cook.</p>
<i>F 5</i> + heat level and signal tone	<p>There is hot cookware near the control panel. The electronics are at risk of overheating.</p> <ul style="list-style-type: none"> <li>▶ Remove the cookware from the control panel.</li> <li>✓ You can continue to cook.</li> </ul>

Issue	Cause and troubleshooting
<i>F 5</i> and signal tone	There is hot cookware near the control panel. The cooking zone has switched off to protect the electronics. <ol style="list-style-type: none"> <li>1. Remove the cookware from the control panel.</li> <li>2. Wait a few seconds.</li> <li>3. Touch any control element.</li> </ol> ✓ When error message disappears, the electronics have cooled down sufficiently. You can continue to cook.
<i>F 1 / F 6</i>	The cooking zone has overheated. It has switched off to protect the work surface. <ol style="list-style-type: none"> <li>1. Wait until the electronics have cooled down sufficiently.</li> <li>2. Switch the cooking zone back on.</li> </ol> ✓ You can continue to cook.
<i>F 0</i>	The transfer function cannot be activated <ol style="list-style-type: none"> <li>1. Acknowledge the fault code by touching any touch key.</li> <li>2. Test the transfer function by setting down the original item of cookware.</li> <li>3. If the issue persists, call Customer Support.</li> <li>4. You can cook as usual without using the transfer function.</li> </ol>
<i>F 8 + H / h</i> and cooking zones not heating	The cooking zone has been operating continuously for an extended period of time without interaction. The automatic time limitation has been triggered. <ul style="list-style-type: none"> <li>▶ Touch any control element.</li> </ul> ✓ You can set the cooking zone and continue to cook.
<i>E 7 0 1 0</i> is displayed.	The cooktop is unable to connect to your home network or to the hood. <ol style="list-style-type: none"> <li>1. Switch the appliance off and on again.</li> </ol> ✓ If the fault was a one-off occurrence, the message disappears. <ol style="list-style-type: none"> <li>2. If the message appears again, call Customer Service. Please specify the exact error message when calling.</li> </ol> → "Customer Service", Page 44
The cooking position has been switched off. <i>E 8 2 0 2</i> is displayed.	The cooking sensor has overheated. <ol style="list-style-type: none"> <li>1. Wait until the cooking sensor has cooled down.</li> <li>2. Activate the cooking sensor function again.</li> </ol>
All cooking position adjacent to the cooking sensor have been switched off. <i>E 8 2 0 3</i> is displayed.	The cooking sensor has overheated. <ol style="list-style-type: none"> <li>1. If you are not using the cooking sensor function, remove the wireless cooking sensor from the cookware and keep it away from the cooking zones and other heat sources.</li> <li>2. Turn the cooking zone back on.</li> </ol>
<i>E 8 2 0 4</i> is displayed.	The battery of the wireless cooking sensor is almost drained. <ul style="list-style-type: none"> <li>▶ Replace the 3 V CR2032 battery.</li> </ul>
<i>E 8 2 0 5</i> is displayed.	The connection to the cooking sensor is lost. <ul style="list-style-type: none"> <li>▶ Deactivate the cooking sensor function and activate it again.</li> </ul>
<i>E 8 2 0 6</i> is displayed.	The wireless cooking sensor is faulty. <ul style="list-style-type: none"> <li>▶ Inform Customer Support.</li> </ul>
The cooking sensor symbol does not light up and the wireless cooking sensor is not responding.	The battery of the wireless cooking sensor is almost drained. <ul style="list-style-type: none"> <li>▶ Replace the 3 V CR2032 battery.</li> </ul> The connection to the cooking sensor is lost. <ol style="list-style-type: none"> <li>1. Press and hold the symbol on the wireless cooking sensor for 8-10 seconds.</li> <li>2. Reconnect the wireless cooking sensor to the cooktop.</li> <li>3. If the problem persists, call Customer Support.</li> </ol>
The cooking sensor indicator flashes twice.	The battery of the wireless cooking sensor is almost drained. <ul style="list-style-type: none"> <li>▶ Replace the 3 V CR2032 battery.</li> </ul>
The cooking sensor indicator flashes three times.	The connection to the cooking sensor is lost. <ol style="list-style-type: none"> <li>1. Press and hold the symbol on the wireless cooking sensor for 8-10 seconds.</li> <li>2. Reconnect the wireless cooking sensor to the cooktop.</li> <li>3. If the problem persists, call Customer Support.</li> </ol>
<i>E 9 0 0 0 / E 9 0 1 0</i>	The supply voltage is incorrect. It is outside the normal operating range. <ul style="list-style-type: none"> <li>▶ Contact your electrical utility provider.</li> </ul>
<i>U 4 0 0</i>	The supply voltage is incorrect. It is outside the normal operating range. <ul style="list-style-type: none"> <li>▶ Contact your electrical utility provider.</li> </ul>



Issue	Cause and troubleshooting
$dE$ and cooking zones do not heat up	<p>Demo mode is activated.</p> <ol style="list-style-type: none"> <li>1. Disconnect the appliance from the power supply for 30 seconds by switching off the circuit breaker or fuse in the electrical panel.</li> <li>2. Touch any touch field within the next 3 minutes.</li> </ol>

## 11.1 Additional information

### Notes

- If  $E$  lights up on the display, press and hold the touch key for the cooking zone in question, in order to read the fault code.

- If the fault code is not listed in the table, disconnect the cooktop from the power supply, wait 30 seconds, and then reconnect it again. If the display appears again, contact Customer Support and tell them the precise fault code.
- If a fault occurs, the appliance will not switch to standby mode.

## 11.2 Testing cookware suitability

With this function you can check the speed and quality of the cooking process for individual pieces of cookware.

### Requirements

- The cookware is cold.
  - You have read the recommendations for induction cooking → *Page 10*.
1. Fill the cookware with approximately 8 oz. (200 ml) of water.
  2. Place the cookware on the cooking zone that best matches the base of the cookware. Center the cookware on the cooking zone.

If the diameter of the cooking zone is much smaller than the diameter of the cookware, only the middle of the cookware will heat up. This may have a negative effect on the cooking results.

3. Touch any control element in the settings range.
  - ✓  $_$  flashes in the cooking zone display.
  - ✓ The result of the test appears in the cooking zone display after 10 seconds.  
→ *"Possible Results for Cookware Suitability Test", Page 42*

**Note:** The flexible cooking zone only counts as a single cooking zone; place no more than one item of cookware on it.

## Possible Results for Cookware Suitability Test

There are three possible outcomes for the cookware suitability test.

Display	Meaning
$d$	The cookware is not suitable for the cooking zone. It will not heat up. If possible, test the cookware again on a smaller cooking zone.
$i$	The cookware takes longer than expected to heat up. The cooking process is not ideal. If possible, test the cookware again on a smaller cooking zone.
$z$	The cookware heats up correctly. The cooking process is good.

## 12 FAQs

### 12.1 Using the appliance

Question	Answer
Why can't I switch on the cooktop and why is the childproof lock symbol lit?	<ul style="list-style-type: none"> <li>■ The childproof lock is activated. You can find further information about this function under .</li> </ul>
Why are the illuminated displays flashing and why is a signal sounding?	<ul style="list-style-type: none"> <li>■ Clean any the surface of the control panel of any liquids or food residue. Remove any objects that may cover the control panel. You can find further information about deactivating the signal tone under → "<i>Basic settings</i>", Page 32.</li> </ul>
Why can I not activate the cooking assistance functions?	<ul style="list-style-type: none"> <li>■ The appliance has reached its maximum power consumption or the power manager function has been activated. Switch off or reduce the power levels of the active cooking zones. You can find further information about this function under → "<i>Power limitation</i>", Page 33.</li> </ul>

### 12.2 Noises

Question	Answer
Why I can hear noises while I'm cooking?	<ul style="list-style-type: none"> <li>■ Noises may be generated while using the cooktop depending on the properties of the base of the cookware. These noises are normal for induction technology. They do not indicate that there is a fault.</li> </ul>
Possible noises	<ul style="list-style-type: none"> <li>■ <b>A deep humming noise similar to a transformer:</b> Occurs when cooking at a high power level. This noise disappears or becomes quieter when you reduce the power level.</li> <li>■ <b>A quiet whistling noise:</b> This can be heard when the cookware is empty. This noise disappears when you add water or food to the cookware.</li> <li>■ <b>Crackling:</b> This noise occurs when the cookware is made from different multilayer materials, or if you use cookware of different sizes and different materials. The volume of the noise can vary depending on the quantity of food being cooked or the cooking method.</li> <li>■ <b>Loud whistling noises:</b> These may arise if you are operating two cooking zones at the same time and at the maximum power level. These whistling noises disappear or become quieter when you reduce the power level.</li> <li>■ <b>Fan noises:</b> The cooktop is equipped with a fan that switches on automatically at high temperatures. The fan may also continue to run after you have switched the cooktop off if the temperature measured is still too high.</li> </ul>

### 12.3 Items of cookware

Question	Answer
Which cookware is suitable for the induction cooktop?	<ul style="list-style-type: none"> <li>■ You can find additional information on which items of cookware are suitable for the induction cooking under → "<i>Induction cooking</i>", Page 10.</li> </ul>
Why is the cooking zone not heating up and why is the power level flashing?	<ul style="list-style-type: none"> <li>■ The cookware is on a different cooking zone to the one that has been switched on. Ensure that you have switched on the correct cooking zone for the cookware.</li> <li>■ The cookware is too small for the cooking zone that is switched on or it is not suitable for induction cooking. Ensure that the cookware is suitable for induction cooking and that it is placed on the cooking zone which best corresponds to its size. You can find more information about this under → "<i>Induction cooking</i>", Page 10 .</li> </ul>
Why is it taking so long for the cookware to heat up or why is it not heating up sufficiently despite being on a high power setting?	<ul style="list-style-type: none"> <li>■ The cookware is too small for the cooking zone that is switched on or it is not suitable for induction cooking. Ensure that the cookware is suitable for induction cooking and that it is placed on the cooking zone which best corresponds to its size. You can find more information about this under → "<i>Induction cooking</i>", Page 10.</li> </ul>

## 12.4 Cleaning

Question	Answer
How can I clean the cook-top?	<ul style="list-style-type: none"> <li>You can achieve the best results by using special glass-ceramic cleaning products. Do not use harsh or abrasive cleaning products, dishwasher detergent (concentrated) or scouring pads. You can find more information about this under → "Cleaning and maintenance", Page 38.</li> </ul>

## 13 Disposal

### 13.1 Disposal of your old appliance

Environmentally compatible disposal allows valuable raw materials to be recycled.

- ▶ Dispose of the appliance in an environmentally responsible manner.

Information about current disposal methods can be obtained from your specialist dealer or local authority.

## 14 Customer Service

With any warranty repair, we will make sure your appliance is repaired by an authorized service provider using genuine replacement parts. We use only genuine replacement parts for all repairs.

Detailed information on the warranty period and terms of warranty can be found in the Statement of Limited Product Warranty, from your retailer, or on our website.

If you contact the Customer Service, you will need the model number (E-Nr.) and the production number (FD) of your appliance.

USA:

1-877-442-4436

[www.gaggenau.com](http://www.gaggenau.com)

[www.gaggenau.com/us/appliances/eshop](http://www.gaggenau.com/us/appliances/eshop)

CA:

1-877-442-4436

[www.gaggenau.com](http://www.gaggenau.com)

[www.gaggenau.ca](http://www.gaggenau.ca)

For assistance with connecting to Home Connect™, you can also view instructions here:

[www.home-connect.com/us/en/help-support/set-up](http://www.home-connect.com/us/en/help-support/set-up)

### 14.1 Model number (E-Nr.) and production number (FD)

You can find the model number (E-Nr.) and the production number (FD) on the appliance's rating plate.

The model number (E-Nr.) can also be found on the glass ceramic. You can also display the customer service index (KI) and the production number (FD) in the Basic settings → Page 32.

Making a note of your appliance's details and the Customer Service telephone number will enable you to find them again quickly.

### 14.2 Rating plate location

You can find the rating plate of your appliance:

- on the underside of the appliance
- in the appliance pass

- You can also check the Customer Service Index (CSI) and the FD number in the basic settings.

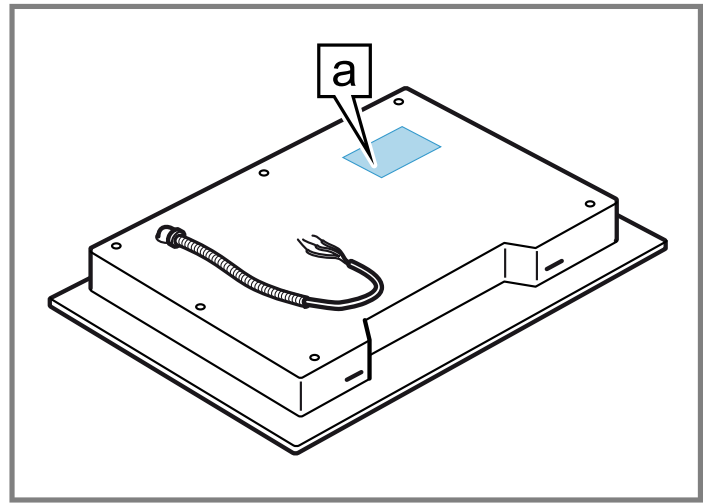

**a** Rating plate

## 15 STATEMENT OF LIMITED PRODUCT WARRANTY

### 15.1 What this warranty covers & Who it applies to

The limited warranty provided by BSH Home Appliances ("Gaggenau") in this Statement of Limited Product Warranty applies only to the Gaggenau appliance sold to you ("Product"), provided that the Product was purchased:

- For your normal, household (non-commercial) use, and has in fact at all times only been used for normal household purposes.
- New at retail from a BSH authorized dealer or directly from BSH (not a display, "as is", or previously returned model), and not for resale, or commercial use.
- Within the United States or Canada, and has at all times remained within the country of original purchase.

The warranties stated herein apply to the original purchaser of the product warranted herein and to each succeeding owner of the product purchased for ordinary home use during the term of the warranty.

Please make sure to register your Product; while not necessary to effectuate warranty coverage, it is the best way for Gaggenau to notify you in the unlikely event of a safety notice or product recall.

## 15.2 How long the warranty lasts

Gaggenau warrants that the Product is free from defects in materials and workmanship for a period of seven hundred and thirty (730) days from the date of the original delivery. The foregoing timeline begins to run upon the date of original delivery, and shall not be stalled, tolled, extended, or suspended, for any reason whatsoever. This Product is also warranted to be free from **cosmetic** defects in material and workmanship (such as scratches of stainless steel, paint/porcelain blemishes, chips, dents, or other damage to the finish) of the Product, for a period of sixty (60) days from the date of delivery or closing date for new construction. This **cosmetic** warranty excludes slight color variations due to inherent differences in painted and porcelain parts, as well as differences caused by kitchen lighting, product location, or other similar factors. This **cosmetic** warranty specifically excludes any display, floor, "As Is", or "B" stock appliances.

## 15.3 Repair/replace as your exclusive remedy

During this warranty period, Gaggenau or one of its authorized service providers will repair your Product without charge to you (subject to certain limitations stated herein) if your Product proves to have been manufactured with a defect in materials or workmanship. If reasonable attempts to repair the Product have been made without success, then Gaggenau will replace your Product (upgraded models may be available to you, in Gaggenau's sole discretion, for an additional charge). Nothing in this warranty requires damaged or defective parts to be replaced with parts of a different type or design than the original parts. All removed parts and components shall become the property of Gaggenau at its sole option. All replaced and/or repaired parts shall assume the identity of the original part for purposes of this warranty and this warranty shall not be extended with respect to such parts. Gaggenau's sole liability and responsibility hereunder is to repair manufacturer-defective Product only, using a Gaggenau authorized service provider during normal business hours. For safety and property damage concerns, Gaggenau highly recommends that you do not attempt to repair the Product yourself, or use a non-authorized service provider; Gaggenau will have no responsibility or liability for damage resulting from repairs or work performed by a non-authorized service provider. Authorized service providers are those persons or companies that have been specially trained on Gaggenau products, and who possess, in Gaggenau's opinion, a superior reputation for customer service and technical ability (note that they are independent entities and are not agents, partners, affiliates or representatives of Gaggenau). Nevertheless, taking your product to be serviced by a repair shop that is not affiliated with or an authorized dealer of Gaggenau will not void this warranty. Also, using third-party parts will not void this warranty. Notwithstanding the foregoing, Gaggenau will not incur any liability, or have responsibility, for the Product if it is located in a remote area (more than 100 miles from an authorized service provider) or is reasonably inaccessible, hazardous, threatening, or treacherous locale, surroundings, or environment; in any such event, if you request, Gaggenau would still pay for labor and parts and ship the parts to the nearest authorized service provider, but you would still be fully liable and responsible for any travel time or other special charges by the service company, assuming they agree to make the service call. Further, to the ex-

tent you have installed the Product in a difficult-to-access location or have otherwise installed temporary or permanent fixtures that create barriers to accessing or removing the Product, Gaggenau will not incur any liability for, or have responsibility, for work or costs associated with moving the Product or otherwise creating access to the Product in order to repair or replace it. All such costs shall be your sole responsibility.

## 15.4 Out of warranty product

Gaggenau is under no obligation, at law or otherwise, to provide you with any concessions, including repairs, pro-rates, or Product replacement, once this warranty has expired.

## 15.5 Warranty exclusions

The warranty coverage described herein excludes all defects or damage that are not the direct fault of Gaggenau, including without limitation, one or more of the following:

- Use of the Product in anything other than its normal, customary and intended manner (including without limitation, any form of commercial use, use or storage of an indoor product outdoors, use of the Product in conjunction with air or water-going vessels).
- Any party's willful misconduct, negligence, misuse, abuse, accidents, neglect, improper operation, failure to maintain, improper or negligent installation, tampering, failure to follow operating instructions, mishandling, unauthorized service (including selfperformed "fixing" or exploration of the appliance's internal workings).
- Adjustment, alteration or modification of any kind.
- A failure to comply with any applicable state, local, city, or county electrical, plumbing and/or building codes, regulations, or laws, including failure to install the product in strict conformity with local fire and building codes and regulations.
- Ordinary wear and tear, spills of food, liquid, grease accumulations, or other substances that accumulate on, in, or around the Product.
- Any external, elemental and/or environmental forces and factors, including without limitation, rain, wind, sand, floods, fires, mud slides, freezing temperatures, excessive moisture or extended exposure to humidity, lightning, power surges, structural failures surrounding the appliance, and acts of God.
- Service calls to correct the installation of your Product, to instruct you how to use your Product, to replace house fuses or correct house wiring or plumbing.
- Removal and replacement of trim or decorative panels that interfere with servicing the Product.
- Damage or defects caused by labor or parts installed by any non-authorized service provider, unless approved by Gaggenau before service is performed.

In no event shall Gaggenau have any liability or responsibility whatsoever for damage to surrounding property, including cabinetry, floors, ceilings, and other structures or objects around the Product. Also excluded from this warranty are Products, on which the serial numbers have been altered, defaced, or removed; service visits to teach you how to use the Product, or visits where there is nothing wrong with the Product; correction of installation problems (you are solely responsible for any structure and setting for the Product, including all electrical, plumbing or other connecting facilities, for proper foundation/flooring,

and for any alterations including without limitation cabinetry, walls, floors, shelving, etc.); and resetting of breakers or fuses

TO THE EXTENT ALLOWED BY LAW, THIS WARRANTY SETS OUT YOUR EXCLUSIVE REMEDIES WITH RESPECT TO PRODUCT, WHETHER THE CLAIM ARISES IN CONTRACT OR TORT (INCLUDING STRICT LIABILITY, OR NEGLIGENCE) OR OTHERWISE. THIS WARRANTY IS IN LIEU OF ALL OTHER WARRANTIES, WHETHER EXPRESS OR IMPLIED. ANY WARRANTY IMPLIED BY LAW, WHETHER FOR MERCHANTABILITY OR FITNESS FOR A PARTICULAR PURPOSE, OR OTHERWISE, SHALL BE EFFECTIVE ONLY FOR THE PERIOD THAT THIS EXPRESS LIMITED WARRANTY IS EFFECTIVE. IN NO EVENT WILL THE MANUFACTURER BE LIABLE FOR CONSEQUENTIAL, SPECIAL, INCIDENTAL, INDIRECT, "BUSINESS LOSS", AND/OR PUNITIVE DAMAGES, LOSSES, OR EXPENSES, INCLUDING WITHOUT LIMITATION TIME AWAY FROM WORK, HOTELS AND/OR RESTAURANT MEALS, REMODELLING EXPENSES IN EXCESS OF DIRECT DAMAGES WHICH ARE DEFINITELY CAUSED EXCLUSIVELY BY GAGGENAU, OR OTHERWISE. SOME STATES DO NOT ALLOW THE EXCLUSION OR LIMITATION OF INCIDENTAL OR CONSEQUENTIAL DAMAGES, AND SOME STATES DO NOT ALLOW LIMITATIONS ON HOW LONG AN IMPLIED WARRANTY LASTS, SO THE ABOVE EXCLUSIONS OR LIMITATIONS MAY NOT APPLY TO YOU. THIS WARRANTY GIVES YOU SPECIFIC LEGAL RIGHTS, AND YOU MAY ALSO HAVE OTHER RIGHTS WHICH VARY FROM STATE TO STATE.

No attempt to alter, modify or amend this warranty shall be effective unless authorized in writing by an officer of BSH.

### 15.6 Obtaining warranty service

To obtain warranty service for your product, you should contact Gaggenau Customer Support at 1-877-442-4436 to schedule a repair.

### 15.7 Product information

For handy reference, copy the information below from the rating plate. Keep your invoice and/or delivery documents for warranty validation.

Model number (E-Nr.)
Production number (FD)
Date of delivery



A series of horizontal lines for writing, starting from the top line and extending to the bottom of the page.



**BSH Home Appliances Corporation**  
1901 Main Street, Suite 600  
Irvine, CA 92614  
USA  
[www.gaggenau.com](http://www.gaggenau.com)  
1-877-442-4436  
© 2022 BSH Home Appliances Corporation

**GAGGENAU**



9001444922 en-us (021110)