

Gaggenau

Use and care manual

VI 492 613

Cooktop

VI 492 613

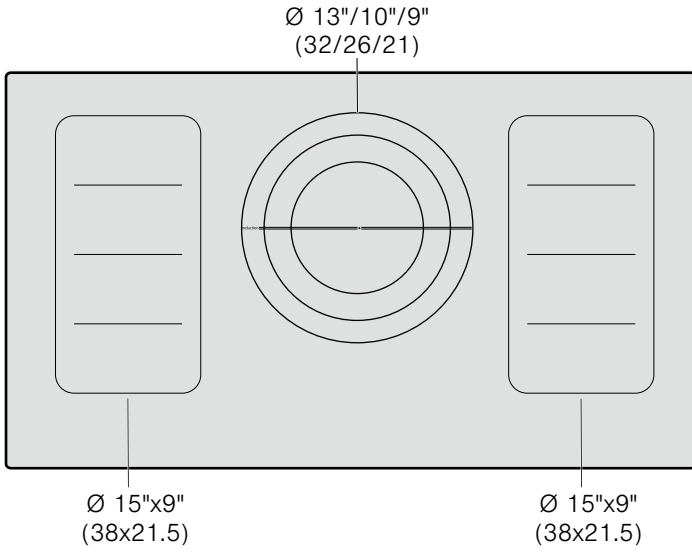

Table of Contents

▲ Safety Definitions	4	Timer functions	22
IMPORTANT SAFETY INSTRUCTIONS	5	The kitchen timer	22
Fire Safety	5	Stopwatch Function	22
Cooking Safety	6	PowerBoost Function	23
Burn Prevention	6	Activate	23
Child Safety	7	Deactivate	23
Cleaning Safety	7	Frying Sensor	23
Cookware Safety	8	Advantages When Frying	23
Proper Installation and Maintenance	8	Frying Pans for the Frying Sensor	23
Electromagnetic Interference	9	Temperature Settings	24
Cooling Fan	10	Frying Chart	24
Proposition 65 Warning	10	Setting Procedure	26
Causes of Damage	11	Locking the Control Panel for Cleaning	27
Overview	11	Basic Settings	27
Environmental protection	12	Access the Basic Settings	28
Energy-Saving Advice	12	Home Connect	29
Cooking with induction	12	Setting Up	29
Advantages of Induction Cooking	12	Open or close the Home Connect settings menu	29
Cookware	12	Overview of the Home Connect settings menu	30
Getting to Know your Appliance	14	Connecting the appliance to your home network (Wi-Fi)	30
Control Panel	14	Manual Registration in the Home Network	30
Control Knob	15	Logging in to your home network automatically (WPS)	31
Cooking Zones	15	Exiting the Home Connect settings menu	32
Residual Heat Indicator	15	Switch the wireless network connection (LAN or WLAN) on or off	32
Optional accessories	15	Resetting the Home Connect connections	33
Operating the Appliance	16	Software Update	33
Setting a cooking zone	16	Remote Diagnostics	33
Setting a cooking zone	16	Information on Data Protection	33
Chef's recommendations	17	Declaration of Conformity	33
Wok Function	19	Wi-Fi® Module	34
Wok and Wok Accessories	19	Connecting the extractor hood	34
Cooking with the Wok	19	Connecting appliances via the home network	34
Activate	19	Connecting appliances directly	35
Deactivate	19	Controlling the extractor hood via the cooktop	35
Table	20	Cleaning and Maintenance	36
Flexible cooking zone	21	Daily Cleaning	36
Cookware Use Recommendations	21	Cleaning Guidelines	36
As Two Independent Cooking Zones	21	Cleaning Chart	36
As a Combined Cooking Zone	21	Maintenance	37

FAQ	38
<hr/>	
Faults – what to do?	40
Demo Mode	41
Suitability Test of Cookware	41
<hr/>	
Customer Service	42

Additional information on products, accessories, replacement parts and services, as well as the Use and care manual and the Installation instructions can be found at www.gaggenau.com and in the online shop www.gaggenau.com/zz/store

Safety Definitions

WARNING

This indicates that death or serious injuries may occur as a result of non-observance of this warning.

CAUTION

This indicates that minor or moderate injuries may occur as a result of non-observance of this warning.

NOTICE

This indicates that damage to the appliance or property may occur as a result of non-compliance with this advisory.

Note: This alerts you to important information and/or tips.

IMPORTANT SAFETY INSTRUCTIONS

READ AND SAVE THESE INSTRUCTIONS

WARNING

When properly cared for, your new appliance has been designed to be safe and reliable. Read all instructions carefully before use. These precautions will reduce the risk of burns, electric shock, fire, and injury to persons. When using kitchen appliances, basic safety precautions must be followed, including those in the following pages.

Examine the appliance after unpacking it. In the event of transport damage, do not plug it in.

This appliance is not intended for operation with an external clock timer or a remote control.

This appliance is not intended for use by persons (including children) with reduced physical, sensory or mental capabilities, or lack of experience and knowledge, unless they have been given supervision or instruction concerning use of the appliance by a person responsible for their safety.

Fire Safety

Do not allow pans to boil dry. Do not allow aluminum foil, plastic, paper or cloth to come in contact with a hot surface element, burner or grate. Improper installation of these protective liners may result in a risk of electric shock, or fire.

If the cooktop is near a window, forced air vent or fan, be certain that flammable materials such as window coverings do not blow over or near the burners or elements. They could catch on fire.

Always have a working smoke detector near the kitchen.

Never leave the cooktop unattended when in use. Boilovers cause smoking and greasy spillovers may ignite.

WARNING

TO REDUCE THE RISK OF A GREASE FIRE:

1. Never leave surface units unattended at high settings. Boilovers cause smoking and greasy spillovers that may ignite. Heat oils slowly on low or medium settings.
 2. Always turn hood ON when cooking at high heat or when flambeing food (i.e. Crepes Suzette, Cherries Jubilee, Peppercorn Beef Flambé).
 3. Clean Ventilating Hoods Frequently. Grease should not be allowed to accumulate on hood or filter.
 4. Use proper pan size. Always use cookware appropriate for the size of the surface element.
-

In the event that personal clothing or hair catches fire, drop and roll immediately to extinguish flames.



IMPORTANT SAFETY INSTRUCTIONS

READ AND SAVE THESE INSTRUCTIONS

Have an appropriate fire extinguisher available, nearby, highly visible and easily accessible near the appliance.

Smother flames from food fires other than grease fires with baking soda. Never use water on cooking fires.



WARNING

TO REDUCE THE RISK OF INJURY TO PERSONS IN THE EVENT OF A GREASE FIRE, OBSERVE THE FOLLOWING:

1. Do Not Use Water on Grease Fires - Smother fire or flame or use dry chemical or foam-type extinguisher.
 2. SMOTHER FLAMES with a close-fitting lid, cookie sheet, or metal tray, then turn off the burner. BE CAREFUL TO PREVENT BURNS. If the flames do not go out immediately, EVACUATE AND CALL THE FIRE DEPARTMENT.
 3. NEVER PICK UP A FLAMING PAN – You may be burned.
 4. DO NOT USE WATER, including wet dishcloths or towels – a violent steam explosion will result.
 5. Use an extinguisher ONLY if:
 - You know you have a Class ABC extinguisher, and you already know how to operate it.
 - The fire is small and contained in the area where it started.
 - The fire department is being called.
 - You can fight the fire with your back to an exit.
-

Whenever possible, do not operate the ventilation system during a cooktop fire. However, do not reach through fire to turn it off.

Cooking Safety



WARNING

Use this appliance only for its intended use as described in this manual. NEVER use this appliance as a space heater to heat or warm the room. Doing so may result in overheating the appliance. Never use the appliance for storage.

Burn Prevention

DO NOT TOUCH SURFACE UNITS OR AREAS NEAR UNITS - Surface units may be hot even though they are dark in color. Areas near surface units may become hot enough to cause burns. During and after use, do not touch, or let clothing, potholders, or other flammable materials contact surface units or areas near units until they have had sufficient time to cool. Among these areas are the cooktop and areas facing the cooktop.

Do not heat or warm unopened food containers. Build-up of pressure may cause the container to burst and cause injury.

Always use dry potholders. Moist or damp potholders on hot surfaces may result in burns from steam. Do not let potholder touch hot heating elements. Do not use a towel or other bulky cloth.



IMPORTANT SAFETY INSTRUCTIONS

READ AND SAVE THESE INSTRUCTIONS

Always turn hood ON when cooking at high heat or when flambéing food (i.e. Crêpes Suzette, Cherries Jubilee, Peppercorn Beef Flambé).

Use high heat settings on the cooktop only when necessary. To avoid bubbling and splattering, heat oil slowly, on no more than a low-medium setting. Hot oil is capable of causing extreme burns and injury.

Never move a pan of hot oil, especially a deep fat fryer. Wait until it is cool.

Secure all loose garments, etc., before beginning. Tie long hair so that it does not hang loose, and do not wear loose-fitting clothing or hanging garments, such as ties, scarves, jewelry, or dangling sleeves.



WARNING

Risk of burns!

Metallic objects become hot very quickly on the cooktop. Never set down metallic objects such as knives, forks, spoons and lids on the cooktop.



WARNING

Risk of burns!

After each use, turn off the cooking zone using the control knob. Don't wait until the cooking zone automatically shuts off because there are no cooking vessels on it anymore.

Child Safety

When children become old enough to use the appliance, it is the responsibility of the parents or legal guardians to ensure that they are instructed in safe practices by qualified persons.

Do not allow anyone to climb, stand, lean, sit, or hang on any part of an appliance, especially a door, warming drawer, or storage drawer. This can damage the appliance, and the unit may tip over, potentially causing severe injury.

Do not allow children to use this appliance unless closely supervised by an adult. Children and pets should not be left alone or unattended in the area where the appliance is in use. They should never be allowed to play in its vicinity, whether or not the appliance is in use.



CAUTION

Items of interest to children should not be stored in an appliance, in cabinets above an appliance or on the backsplash. Children climbing on an appliance to reach items could be seriously injured.

Cleaning Safety

Clean Cooktop With Caution - If a wet sponge or cloth is used to wipe spills on a hot cooking area, be careful to avoid steam burn. Some cleaners can produce noxious fumes if applied to a hot surface.

Do not use steam cleaners to clean the appliance.



IMPORTANT SAFETY INSTRUCTIONS

READ AND SAVE THESE INSTRUCTIONS

Cookware Safety

Hold the handle of the pan when stirring or turning food. This helps prevent spills and movement of the pan.

Use Proper Pan Size.

The use of undersized cookware will expose a portion of the heating element or burner to direct contact and may result in ignition of clothing. Select cookware having flat bottoms large enough to cover the surface heating unit. This appliance is equipped with one or more surface units of different sizes. Proper relationship of cookware to heating element or burner will also improve efficiency.

Cookware not approved for use with ceramic cooktops may break with sudden temperature changes. Use only pans that are appropriate for ceramic induction cooktops.

Always position handles of utensils inward so they do not extend over adjacent work areas, burners, or the edge of the cooktop. This reduces the risk of fires, spills and burns.



WARNING

RISK of injury!

Inappropriate woks may cause accidents. Use only the wok provided by the manufacturer as a special accessory.



WARNING

RISK of injury!

When cooking with a double-boiler, the cooktop and cooking vessel may crack due to overheating. The cooking vessel in the double-boiler must not come in direct contact with the bottom of the pot filled with water. Use only heat-resistant cookware.



WARNING

Danger of injury!

Cookware may jump upward due to fluid trapped between the cookware bottom and cooking zone. Always keep cooking zone and cookware bottom dry.

Proper Installation and Maintenance

Have the installer show you the location of the circuit breaker or fuse. Mark it for easy reference.

This appliance must be properly installed and grounded by a qualified technician. Connect only to properly grounded outlet. Refer to Installation Instructions for details.

This appliance is intended for normal family household use only. It is not approved for outdoor use. See the Statement of Limited Product Warranty. If you have any questions, contact the manufacturer.

IMPORTANT SAFETY INSTRUCTIONS

READ AND SAVE THESE INSTRUCTIONS

Do not store or use corrosive chemicals, vapors, flammables or nonfood products in or near this appliance. It is specifically designed for use when heating or cooking food. The use of corrosive chemicals in heating or cleaning will damage the appliance and could result in injury.

Make sure reflector pans or drip bowls are in place - Absence of these bowls or pans during cooking may subject wiring or components underneath to damage.

WARNING

Failure to operate knobs properly may result in personal injury and damage to the appliance.

Do not operate this appliance if it is not working properly, or if it has been damaged. Contact an authorized service provider.

Do Not Cook on Broken Cooktop - If cooktop should break, cleaning solutions and spillovers may penetrate the broken cooktop and create a risk of electric shock. Contact a qualified technician immediately.

WARNING

If the surface is cracked, switch off the appliance to avoid the possibility of electric shock.

Do not repair or replace any part of the appliance unless specifically recommended in this manual. Refer all

servicing to an authorized service provider.

To avoid electrical shock hazard, before servicing the appliance, switch power off at the service panel and lock the panel to prevent the power from being switched on accidentally.

Electromagnetic Interference

WARNING

This induction cooktop generates and uses ISM frequency energy that heats cookware by using an electromagnetic field. It has been tested and complies with Part 18 of the FCC Rules for ISM equipment. This induction cooktop meets the FCC requirements to minimize interference with other devices in residential installation. Induction cooktops may cause interference with television or radio reception. If interference occurs, the user should try to correct the interference by:

- Relocating the receiving antenna of the radio or television.
 - Increasing the distance between the cooktop and the receiver.
 - Connecting the receiver into an outlet different than the cooktop.
-

It is the user's responsibility to correct any interference.

IMPORTANT SAFETY INSTRUCTIONS

READ AND SAVE THESE INSTRUCTIONS

CAUTION

Persons with a pacemaker or similar medical device should exercise caution when standing near an induction cooktop while it is in use. Consult your doctor or the manufacturer of the pacemaker or similar medical device for additional information about its effects with electromagnetic fields from an induction cooktop.

Proposition 65 Warning:

This product may contain a chemical known to the State of California, which can cause cancer or reproductive harm. Therefore, the packaging of your product may bear the following label as required by California:

STATE OF CALIFORNIA PROPOSITION 65 WARNING:

 **WARNING**

Cancer and Reproductive Harm - www.P65Warnings.ca.gov

Cooling Fan

The cooktop is equipped with a cooling fan on its underside. Should the cooktop lie above a drawer, there must be no objects or paper in it. They may be sucked in and compromise the cooling of the appliance or damage the fan.

There must be a minimum distance of $\frac{3}{4}$ " (20mm) between the content of the drawer and the fan input.

Causes of Damage

NOTICE

- Rough pot and pan bases scratch the cooktop.
 - Never leave cookware cooking empty. This can cause damage.
 - Do not place hot pots or pans on the control panel, the displays or the cooktop surround. This can cause damage.
 - Damage can occur if hard or pointed objects fall on the cooktop.
 - Aluminum foil and plastic containers can melt and stick on hot cooking zones. The use of oven protective foil on the cooktop is not recommended.
-

Overview

You will find the most frequently caused damage in the following table.

Damage	Cause	Remedy
Stains	Boiled-over food.	Remove boiled-over food immediately with a glass scraper.
	Unsuitable cleaning agent.	Only use cleaning agents that are suitable for this type of cooktop.
Scratches	Salt, sugar and sand.	Do not use the cooktop as a work surface or storage space.
	Cookware with rough bases scratch the cooktop.	Check the cookware.
Discoloration	Unsuitable cleaning agent.	Only use cleaning agents that are suitable for this type of cooktop.
	Pan abrasion.	Lift pots and pans when moving them.
Blisters	Sugar, food with a high sugar content.	Remove boiled-over food immediately with a glass scraper.

Environmental protection

Energy-Saving Advice

- Place a lid on cookware. Cooking with an uncovered pan will result in a considerable increase in energy use. Use a glass lid to provide visibility and avoid having to lift the lid.
- Use cookware equipped with a solid, flat bottom. Curved pan bases increase energy consumption.
- The diameter of the pan base must match the size of the cooking zone. Note: The manufacturer normally indicates the pan's upper diameter. This is normally greater than the diameter of the pan's base.
- Choose cookware of a size suited to the amount of food you are going to cook. A large pan that is only half full will use a lot of energy.
- Use a small amount of water when cooking. This saves energy, and vegetables retain a larger percentage of their vitamins and minerals.
- Select the lowest power level to maintain cooking. If the power level is too high, energy is wasted.

Cooking with induction

Advantages of Induction Cooking

Induction cooking is very different from traditional cooking methods, as heat builds up directly in the item of cookware. This offers numerous advantages:

- Saves time when boiling and frying.
- Saves energy.
- Easier to care for and clean. Spilled food does not burn on as quickly.
- Heat control and safety – the cooktop increases or decreases the heat supply as soon as the user changes the setting. The induction cooking zone stops the heat supply as soon as the cookware is removed from the cooking zone, without having to switch it off first.

Cookware

Only use ferromagnetic cookware for induction cooking, such as:

- Cookware made from enameled steel
- Cookware made from cast iron
- Special induction-compatible cookware made from stainless steel.

To check whether your cookware is suitable for induction cooking, refer to the section on → *"Suitability Test of Cookware"*.

To achieve a good cooking result, the ferromagnetic area on the base of the pan should match the size of the element. If a element does not detect an item of cookware, try placing it on another element with a smaller diameter.

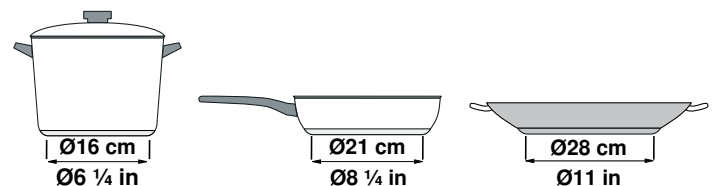

If the only element being used is the flexible cooking zone, larger cookware that is particularly suited to this zone can be used. You can read more information on the positioning of the cookware here → *"Flexible cooking zone"* on page 21

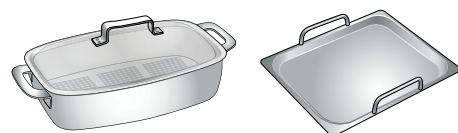

Some induction cookware does not have a fully ferromagnetic base:

- If the base of the cookware is only partially ferromagnetic, only the area that is ferromagnetic will heat up. This may mean that heat will not be distributed evenly. The non-ferromagnetic area may not heat up to a sufficient temperature for cooking.

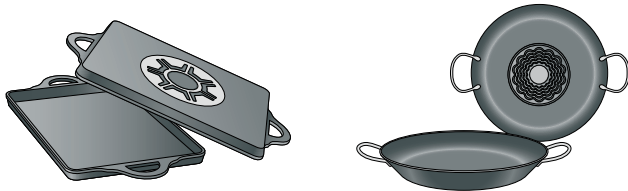

- The ferromagnetic area will also be reduced if the material of which the base of the cookware is made contains aluminum, for example. This may mean that the cookware will not become sufficiently hot or even that it will not be detected.

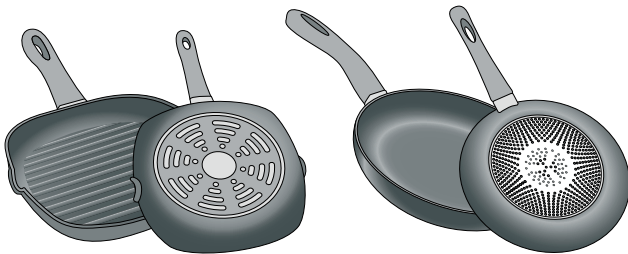

Unsuitable Cookware

Do not ever use adapter plates for induction or cookware made of:

- Traditional stainless steel
- Glass
- Clay
- Copper
- Aluminum

Properties of the Base of the Cookware

The material(s) of which the base of the cookware is made can affect the cooking result. Using pots and pans made from materials that distribute heat evenly through them, such as stainless-steel pans with a three-layer base, saves time and energy.

Use cookware with a flat base; if the base of the cookware is uneven, this may impair the heat supply.

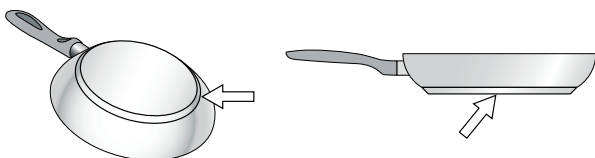

No Cookware on Cooking Zone/Cookware of an Unsuitable Size

If no cookware is placed on the selected cooking zone, if the cookware is made of an unsuitable material, or if it is not the right size for the cooking zone, the cooking zone indicator will start to flash. To stop the indicator from flashing, place suitable cookware on the cooking zone. If it is left flashing for more than 30 seconds, the cooking zone will automatically switch off.

Empty Pans or Pans with a Thin Base

Do not heat up empty pans, or use pans with a thin base. The cooktop is equipped with an internal safety system. However, an empty pan may heat up so quickly that the "automatic shut-off" function may not have time to react, and the pan may reach very high temperatures. The pan base could melt and damage the cooktop glass. In this case, do not touch the pan and switch the cooktop off. If the cooktop fails to work after it has cooled down, please contact Customer Support.

Pan Detection

Each cooking zone has a lower limit for pan detection. This depends on the diameter of the ferromagnetic area of the cookware and the material of which its base is made. For this reason, you should always use the cooking zone that best matches the diameter of the base of the pan.

Automatic Detection in Double and Triple Cooking Zones

These cooking zones can detect cookware of different sizes. Depending on the material and the properties of the cookware, the cooking zone automatically activates the single, double or triple cooking zone, supplying the proper power to obtain good cooking results.

Getting to Know your Appliance

You can find information on the dimensions and power of the cooking zones in → *Page 2*

Note: Depending on the appliance model, individual details and colors may differ.

This appliance can be networked and also controlled remotely using a mobile device. To do this, first connect the appliance to your home network. → *"Home Connect" on page 29*

Control Panel



Controls

	Locking the control panel for cleaning
	Frying sensor
	Basic settings
	Select settings
	Stopwatch
	Short-term timer

Displays

	Operating status
	Power levels
	Residual heat
	Short-term timer
	Stopwatch
	Cooktop
	PowerBoost function
	Flex Zone activated
	Flex Zone deactivated
	Wok function
	Frying Sensor
	Frying sensor temperature display
	Home network

Controls

When the cooktop heats up, the symbols for the controls available at this time light up.

Touch a symbol to activate the function it represents. A confirmation signal sounds.

Notes

- The corresponding symbols for the controls will light up, depending on whether they are available.
- The controls that are available will be lit white. When a function is selected, they turn orange.
- Always keep the control panel clean and dry. Moisture reduces their effectiveness.
- Do not place hot cookware anywhere other than the front cooking zone, and never on the control panel. There is a risk that the control panel's electronics will overheat.

Control Knob

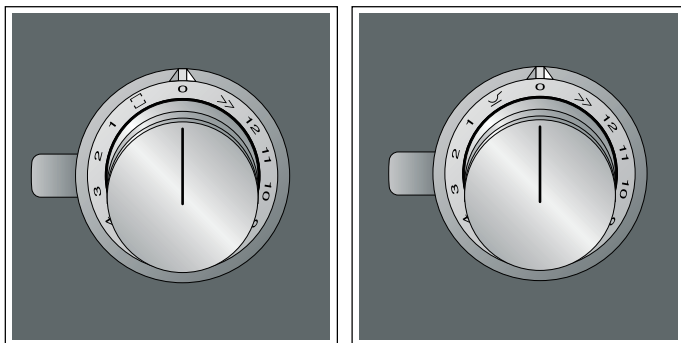

You can use the control knobs to select the heat setting, the PowerBoost function, the flex zone, and the wok function.

1	Lowest heat setting
12	Highest heat setting
>>	PowerBoost Feature
☐	Flex zone activated
☞	Wok Function

The control knobs have an illuminated ring with an illuminated symbol for each function. The illuminated ring changes color when particular functions or processes are activated.

Display	Meaning
○ Off	Appliance OFF
● Lights up orange	Appliance ON
☀ Flashes orange	Appliance OFF Residual heat indicator
● Lights up blue	Home Connect
☀ Flashes blue	Home Connect
☀ Flashes orange and white alternately	Safety shut-off, power failure
☀ Flashes yellow and magenta alternately	Appliance fault Please contact customer service.
● Lights up green for a few seconds, then turns yellow	Appliance initialized, only after initial connection or power failure

The illuminated ring on the control knob lights up orange during operation. You can choose between two shades. If you have several appliances installed next to each other, you can change the shades in the settings for the appliances so that all of the illuminated rings light up in the same shade. → *"Changing the shade of orange for the illuminated ring" on page 17*

Cooking Zones

Cooking zones	
☐ / ○	Single-ring cooking zone Use cookware that is a suitable size.
☉	Triple-ring zone The cooking zone switches on automatically when you use cookware with a base that covers the outer edge of the zone (☉ or ☉).
☐	FlexZone See the section entitled → <i>"Flexible cooking zone"</i> .

Only use cookware that is suitable for induction cooking – see section entitled → *"Cooking with induction"*.

Residual Heat Indicator

The cooktop has a residual heat indicator for each cooking zone. This indicates that a cooking zone is still hot. Do not touch a cooking zone while the residual heat indicator is lit up or immediately after it goes out.

The following are shown depending on the amount of residual heat:

- Display *H*: High temperature
- Display *h*: Low temperature

and the illuminated ring around the control knob will flash.

If the cookware is removed from the cooking zone while cooking is in progress, the heat setting indicator will flash, and the control knob will be lit orange.

Turn the control knob to the 0 position.

If the cooking zone is switched off, the residual heat indicator will be lit, and the illuminated ring around the control knob will flash. Even after the cooktop has been switched off, the residual heat indicator will remain lit for as long as the cooking zone is still warm.

Optional accessories

You can purchase the following accessories from your specialist retailer:

CA 051 300	Multilayer Teppanyaki plate
CA 052 300	Cast aluminum grill plate
WP 400 001	Wok pan
WZ 400 001	Wok ring

Use the accessories only as indicated. The manufacturer assumes no liability for incorrect usage of the accessories.

Operating the Appliance

This chapter explains how to set a cooking zone. The table shows heat settings and cooking times for various meals.

Setting a cooking zone

Use the control knob to select the heat setting you require.

0	Cooking zone off
Heat setting 1	Lowest setting
Heat setting 12	Highest setting

Notes

- To protect the fragile parts of your appliance from overheating and electrical overloading, the cooktop may temporarily reduce the power automatically.
- In order to prevent the appliance from producing excess noise, the cooktop may temporarily reduce the power automatically.

Selecting a Heat Setting

Push in the control knob and turn it to the heat setting you require.

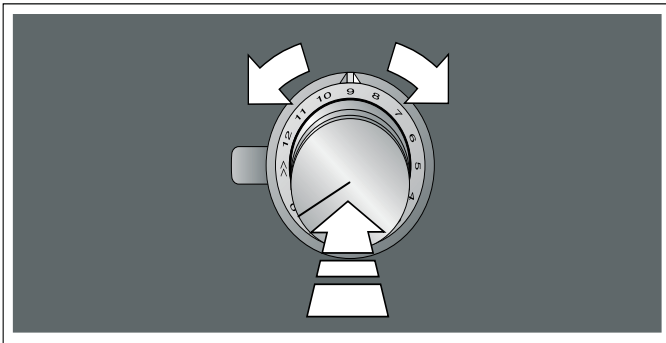

The selected heat setting will be lit on the cooking zone display. The illuminated ring around the control knob will be lit.

Switching Off the Cooking Zone

Turn the control knob to the 0 position.

The residual heat indicator will be lit, and the illuminated ring around the control knob will flash until the cooking zone has cooled down.

Note: If there is no cookware on the cooking zone or if the cookware is not detected, the selected heat setting will flash and the illuminated ring around the control knob will be lit orange. After approx. 30 seconds, the cooking zone will switch off.

In this case, the illuminated ring around the control knob will flash. Turn the control knob back to position 0; the illuminated ring will stop flashing.

Changing the shade of orange for the illuminated ring

The illuminated ring on the control knob lights up orange during operation. You can choose between two shades.

1. Carry out the following operating steps one after the other without interruption.
2. Push in the control knob and turn it anti-clockwise to \gg . Keep the control knob pressed in.
3. Turn the control knob clockwise to position 1. Keep the control knob pressed in.
4. Turn the control knob anti-clockwise to position 0.
The ⌚ symbol will be lit. The illuminated ring around the control knob will be lit yellow.

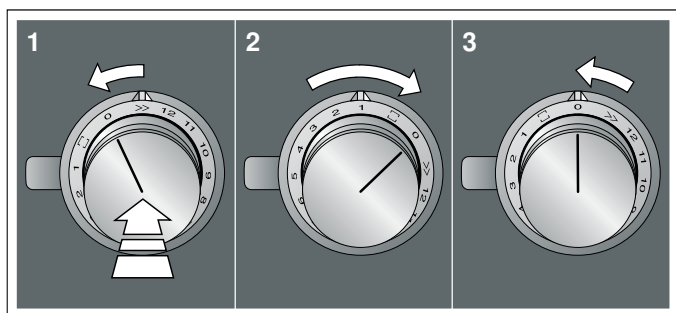

5. Push in the control knob and turn it clockwise to \square .
After approx. five seconds, the illuminated ring around the control knob lights up green. The color has changed.
6. To change the setting back, push in the control knob in and turn it anti-clockwise to position 0 and then back to \square .
The control knob lights up yellow.

Cooking table

The table shows which heat setting is suitable for each type of food. The cooking time may vary depending on the type, weight, thickness and quality of the food.

Heat setting	Cooking methods	Examples
11 - 12	Boiling Searing Heating Bringing to a boil Blanching	Water Meat Fat/oil, liquids Soups, sauces Vegetables
7 - 10	Frying	Meat, potatoes
6 - 8	Frying	Fish
8 - 9	Baking	Flour-based and/or egg-based dishes, e.g., pancakes
	Simmering in an uncovered dish	Dough-based foods, liquids
7 - 8	Browning Roasting Rendering Reducing	Flour, onions Almonds, breadcrumbs Bacon Stocks, sauces

7. To save the setting, exit the menu in the same way:
Push in the control knob and turn it anti-clockwise to \gg . Turn the control knob clockwise to position 1. Turn the control knob anti-clockwise to position 0.

The illuminated ring around the control knob goes out.

The settings have been saved.

Chef's recommendations

Recommendations

- When heating up puree, cream soups, and thick sauces, stir occasionally.
- Set heat setting 10 to 12 for preheating.
- When cooking with the lid on, reduce the heat as soon as you see steam escaping. The cooking result is not affected by the steam escaping.
- After cooking, keep the lid on the cookware until you serve the food.
- To cook with the pressure cooker, observe the manufacturer's instructions.
- Do not cook food for too long, otherwise the nutrients will be lost. The short-term timer can be used to set the optimum cooking time.
- For a healthier result, ensure that the oil does not smoke.
- To brown food, fry it in small batches.
- Cookware may reach high temperatures while the food is cooking. Use oven mitts.
- You can find recommendations for energy-efficient cooking in section → "Environmental protection"

Heat setting	Cooking methods	Examples
6 - 7	Poaching in an uncovered dish	Dumplings, soup pasta, soup vegetables, soup meat, poached eggs
5 - 6	Poaching in an uncovered dish	Boiled sausages
6 - 7	Steaming	Vegetables, potatoes, fish
	Steaming	Vegetables, fruit, fish
	Braising	Roulade, roasts, vegetables
3 - 4	Braising	Goulash
4 - 5	Cooking with the lid on	Soups, sauces
3 - 4	Defrosting	Frozen foods
	Soaking	Rice, legumes, vegetables
	Thickening	Egg-based dishes, e.g., omelette
1 - 2	Heating/keeping warm	Soup, vegetables in sauce
1	Heating/keeping warm	Stew
	Melting	Butter, chocolate

Wok Function

The wok feature is only to be used with the wok pan and wok accessories; it is not suitable for other types of cookware.

Wok and Wok Accessories

(Not included with the appliance)

Wok pans and wok pan supports can be purchased from our sales partner Gaggenau.

Since the base of the wok pan is round, it can only be used with a wok pan support.

Ensure that the wok is properly positioned on the wok pan support when using it for cooking. Always position the wok pan support in the center of the cooking zone.

Do not heat the wok up when it is empty.

Use a special curved turner (chan) or a long-handled wooden turner.

Use a ladle to spoon the food out of the pan. The easiest way to spoon out food cooked in hot fat or large quantities of sauce is with a skimming ladle.

Use a bamboo steamer for steaming.

Notes

- Use the wok and wok pan support in conjunction with the wok function only.
- Do not clean the wok pan support in the dishwasher.

Cooking with the Wok

Sautéing is one of the most popular cooking methods to use with a wok. The ingredients are cut small and cooked very quickly at a high temperature, with constant stirring. The large, round-bottomed pan allows you to stir all the ingredients easily and quickly and turn them as you would in a normal frying pan. Stirring prevents the ingredients from sticking to the pan. Any excess fat collects in the center of the pan. The meat pores will close and the meat will remain succulent. Vegetables will remain crunchy. The flavor and vitamins will be retained.

Note: The wok allows you to cook more quickly than with a conventional frying pan. For this reason, all the ingredients should be prepared before you start cooking. The order in which the ingredients are added is equally important: Ingredients that take longer to cook (high-fiber vegetables such as carrots) should be added first, and ingredients with a shorter cooking time (e.g., mushrooms, bean sprouts) should not be added until the end.



Proceed as follows here:

- Pour oil into the wok. Peanut oil and soybean oil work well in woks.
- Cut the food into small pieces, but not so small that they burn easily.
- Heat the oil to just below its smoke point; you can now start sautéing the food.
- If you wish to sauté large quantities of food, we recommend that you do this in batches, otherwise not all the ingredients will be in contact with the base of the wok at the same time.

CAUTION

The wok and wok accessories become very hot during cooking. Keep out of reach of children. Do not remove the wok accessories until the residual heat indicator has gone out.

Activate

Push in the control knob and turn it to position . After a few seconds, an audible signal will sound and  will be lit.

The function has now been activated.

Use the control knob to select the heat setting you require.

Deactivate

Turn the control knob to the 0 position. The  display will go out, the residual heat indicator will appear, and the illuminated ring around the control knob will flash.

This function has now been deactivated.

Table

	Preheating setting	Heat setting
Heating large volumes of water		PowerBoost
Sautéing		
Fresh produce, e.g., vegetables	-	10 - 11
Frozen products, e.g., sautéed vegetables and chicken	-	11 - 12
Deep-frying (100-200 g per batch in 1 l oil, deep-fry in batches)		
Fresh products, e.g., spring rolls	12	8 - 9
Frozen products, e.g., spring rolls	12	8 - 9
Frozen vegetables in tempura batter	12	10 - 11
Vegetables in tempura batter	12	9 - 10
Cooking with the lid off		
Soup	12	6 - 7
Fondue		
Cheese fondue	6	3 - 4
Chocolate fondue	8	3 - 4
Making sauces		
e.g., teriyaki sauce	-	2 - 3
Keeping food Warm	-	1 - 2

Flexible cooking zone

You can use the flexible cooking zone as a single cooking zone or as two independent cooking zones, as required.

It consists of four inductors that work independently of each other. If the flexible cooking zone is in use, only the area that is covered by cookware is activated.

Note: Only use cookware with a suitable diameter. The base of the cookware should not protrude over the marked cooking zones.

Cookware Use Recommendations

Place the cookware in the middle. This assures optimal pot detection and heat distribution.

As a single cooking zone

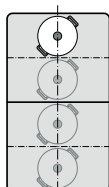

Diameter smaller than or equal to 5 1/8" (13 cm)

Place the cookware on one of the four positions that can be seen in the illustration.

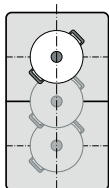

Diameter greater than 5 1/8" (13 cm)

Place the cookware on one of the three positions that can be seen in the illustration.

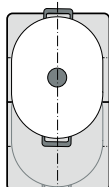

If the cookware takes up more than one cooking zone, place it starting on the upper or lower edge of the flexible cooking zone.

As two independent cooking zones

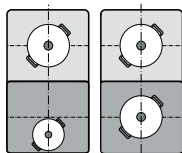

The front and rear cooking zones each have two inductors and can be used independently of each other. Select the required heat setting for each of the cooking zones. Use only one item of cookware on each cooking zone.

As Two Independent Cooking Zones

The flexible cooking zone is used like two independent cooking zones.



Activating

See the section entitled → "Operating the appliance".

As a Combined Cooking Zone

Using the entire cooking zone by connecting both individual zones.

Linking the two Cooking Zones

1. Position the cookware. Turn one of the control knobs to the  position.
2. Use the other control knob to select the heat setting. The  display lights up. The heat setting lights up on the displays for the two cooking zones.

The flex cooking zone has now been activated.

Changing the Heat Setting

To alter the heat setting, use the same control knob you used to select the original heat setting.

Adding New Cookware

Position the new cookware. Turn the control knob that was used to select the flex cooking zone to position 0 and then back to the  position.

The cookware will be detected, and the heat setting that was previously selected will be retained.

Note: If the cookware is moved from the cooking zone being used or lifted up, the cooking zone begins an automatic search and the heat setting selected previously is retained.

Unlinking the Two Cooking Zones

Turn the control knob that was used to select the flex cooking zone to the 0 position. The  display lights up.

The flex cooking zone has now been deactivated. The two cooking zones will now function independently.

Note: If you switch the cooking zone off, and then switch it back on again later, the flexible cooking zone is reset to function as two independent cooking zones.

Timer functions

Your cooktop has two timer functions:

- Timer
- Stop watch

The kitchen timer

You can use the kitchen timer to set a time of up to 99 minutes.

This works independently from the elements and from other settings. This function does not automatically switch off an element.

Setting Procedure

1. Touch the ⌚ symbol; 00 and the – and + symbols will light up on the short-term timer display.
2. Set the required cooking time using the – and + symbols within the next 10 seconds.

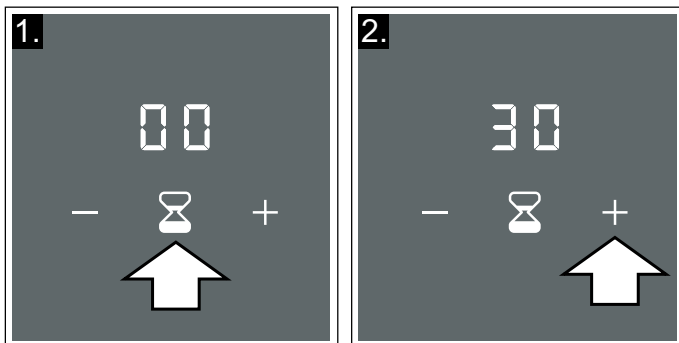

Note: If you press and hold the – or + symbol, you can set the cooking time more quickly.

3. Touch the ⌚ symbol again to confirm the selected cooking time.

The time begins to elapse.

Note: If you do not confirm the setting within 10 seconds, the short-term timer will start automatically.

Changing or Cancelling the Cooking Time

1. Touch the ⌚ symbol.
2. Alter the cooking time using the – and + symbols or set it to 00.
3. Touch the ⌚ symbol to confirm the cooking time.

When the Cooking Time Has Elapsed

An audible signal will sound. 00 flashes in the short-term timer display.

Touch the ⌚ symbol; the indicators will go out and the signal tone will cease.

Stopwatch Function

The stopwatch shows the cooking time that has elapsed so far in minutes and seconds (mm.ss). The maximum duration is 99 minutes and 59 seconds (99.59). If this value is reached, the display starts again at 00.00.

The stopwatch works independently of the cooking zones and other settings. This function does not automatically switch off a cooking zone.

Activate

1. Select a heat setting. The ⌚ display lights up.
2. Touch the ⌚ symbol. 00.00 will light up in the stopwatch display.

The time begins to elapse.

Stopping the Stopwatch

Touching the ⌚ symbol stops the stopwatch function. The stopwatch displays remain lit.

Touching the ⌚ symbol again restarts the stopwatch.

Deactivate

Press and hold the ⌚ symbol for a few seconds. This will stop the stopwatch, and the stopwatch indicators will go out.

This function has now been deactivated.

PowerBoost Function

The PowerBoost function enables you to heat up large volumes of water faster than when using heat setting $i2$.

This function is available for all cooking zones, provided the other cooking zone in the same group is not in use. Otherwise, P and $i2$ will flash on the display for the selected cooking zone; the $i2$ heat setting will then be set automatically without activating this function. In this case, turn the control knob to position 0.

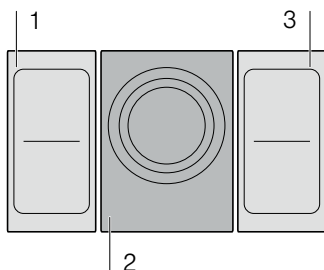

Note: The power boost function can also be activated in the flexible cooking zone if the cooking zone is being used as a single cooking zone.

Activate

Push in the control knob and turn it to the \gg position. The P and \gg displays will light up.

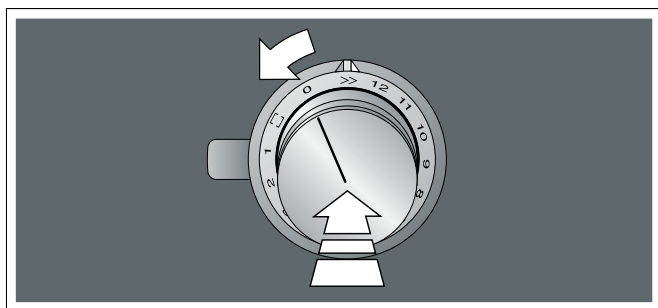

The function has now been activated.

Deactivate

Turn the control knob to the heat setting you require. The P and \gg display will go out and the heat setting you have selected will be lit.

This function has now been deactivated.

Note: In certain circumstances, the PowerBoost function may switch itself off automatically in order to protect the electronic elements inside the cooktop.

In this case, the heat setting $i2$ will automatically be set. Turn the control knob to the 0 position or whichever heat setting you require.

Frying Sensor

This function can be used to fry food while maintaining the suitable frying pan temperature.

Advantages When Frying

- The cooking zone only heats up if this is required to maintain the temperature. This saves energy and prevents the oil or fat from overheating.
- The frying sensor function reports when the empty frying pan has reached the optimum temperature for adding oil and then for adding the food.

Notes

- Do not place a lid on the pan. Otherwise, the function does not activate correctly. You can use a splash guard to prevent splashes of grease.
- Use oil or grease that is suitable for deep fat frying. If butter, margarine, extra virgin olive oil, or lard is used, use heat setting 1 or 2.
- Never leave a frying pan, with or without food, unattended when it is being heated.
- If the temperature of the cooking zone is higher than that of the cookware or vice-versa, the frying sensor is not activated correctly.

Frying Pans for the Frying Sensor

Frying pans specifically suited for use with the frying sensor are available. This optional accessory can be purchased separately from specialist retailers or through our technical after-sales service. Always quote the relevant reference number.

- GP900001 15 cm frying pan.
- GP900002 19 cm frying pan.
- GP900003 21 cm frying pan.
- GP900004 28 cm frying pan. Only recommended for the triple cooking zone.

These frying pans have a non-stick coating so that you only need a small amount of oil to fry food.

Notes

- The frying sensor has been configured specifically for this type of frying pan.
- Ensure that the diameter of the base of the frying pan corresponds to the size of the cooking zone. Place the frying pan in the center of the cooking zone.
- The frying sensor may not activate on the flex cooking zone if the frying pan does not match the size of the cooking zone or if it is positioned incorrectly. See section → *"Cookware Use Recommendations"*
- Other types of frying pan may overheat. They may reach a temperature above or below the selected temperature setting. Select the lowest temperature setting to begin with and change it if necessary.

Temperature Settings

Heat setting	Suitable for
1 Very low	Preparing and reducing sauces, steaming vegetables, and frying food in extra virgin olive oil, butter, or margarine.
2 Low	Frying food using extra virgin olive oil, butter, or margarine, e.g. omelettes.
3 Low – medium	Frying fish and thick food, such as, meatballs and sausages.
4 Medium – high	Frying steaks (medium or well done), frozen breaded products, thin fried food, such as schnitzel, strips of meat, and vegetables.
5 High	Frying food at high temperatures, e.g. rare steaks (bloody), potato fritters, and fried potatoes.

Frying Chart

The chart lists which heat setting is suitable for each type of food. The frying time may vary depending on the type, weight, size and quality of the food.

Preheat the empty pan; add oil and food after the acoustic signal has sounded.

The set heat setting varies depending on the frying pan that is used.

	Temperature setting	Total frying time after the signal tone sounds (min)
Meat		
Schnitzel, plain or breaded	4	6 - 10
Fillet	4	6 - 10
Chops*	3	10 - 15
Cordon bleu*	4	10 - 15
Steak, rare (1¼" / 3 cm thick)	5	6 - 8
Steak, medium or well done (1¼" / 3 cm thick)	4	8 - 12
Chicken breast (¾" / 2 cm thick)*	3	10 - 20
Sausages, pre-boiled or raw*	3	8 - 20
Hamburgers, rissoles*	3	6 - 30
Strips of meat, gyros	4	7 - 12
Ground meat	4	6 - 10
Bacon	2	5 - 8

* Turn several times.

** Total cooking time per portion. Fry one after the other.

	Temperature setting	Total frying time after the signal tone sounds (min)
Fish		
Fried whole fish, e.g. trout	3	10 - 20
Fish fillet, plain or breaded	3 - 4	10 - 20
Scampi, shrimps	4	4 - 8
Egg dishes		
Pancakes**	5	1,5 - 2,5
Omelet**	2	3 - 6
Fried eggs	2 - 4	2 - 6
Scrambled eggs	2	4 - 9
Raisin pancake	3	10 - 15
French toast**	3	4 - 8
Potatoes		
Fried potatoes (made from unpeeled boiled potatoes)	5	6 - 12
Fried potatoes (made from raw potatoes)	4	15 - 25
Potato pancakes**	5	2,5 - 3,5
Swiss rösti	2	50 - 55
Glazed potatoes	3	15 - 20
Vegetables		
Garlic, onions	1 - 2	2 - 10
Zucchini, eggplants	3	4 - 12
Peppers, green asparagus	3	4 - 15
Braising vegetables (fried in fat but with no water added), e.g. zucchini, green peppers	1	10 - 20
Mushrooms	4	10 - 15
Glazed vegetables	3	6 - 10
Fried onions	3	5 - 10
Frozen products		
Schnitzel	4	15 - 20
Cordon bleu*	4	10 - 30
Poultry breast*	4	10 - 30
Chicken nuggets	4	10 - 15
Gyros, kebab	4	10 - 15
Fish fillet, plain or breaded	3	10 - 20
Fish sticks	4	8 - 12
French fries	5	4 - 6
Pan-fried dishes, e.g. fried vegetables with chicken	3	6 - 10
Spring rolls	4	10 - 30
Camembert/cheese	3	10 - 15

* Turn several times.

** Total cooking time per portion. Fry one after the other.

	Temperature setting	Total frying time after the signal tone sounds (min)
Sauces		
Tomato sauce with vegetables	1	25 - 35
Béchamel sauce	1	10 - 20
Cheese sauce, e.g. Gorgonzola sauce	1	10 - 20
Reduced sauces, e.g. tomato sauce, Bolognese sauce	1	25 - 35
Sweet sauces, e.g. orange sauce	1	15 - 25
Miscellaneous		
Camembert/cheese	3	7 - 10
Dried instant meals to which water is added, e.g. pasta dishes	1	5 - 10
Croutons	3	6 - 10
Almonds/walnuts/pine nuts	4	3 - 15

* Turn several times.

** Total cooking time per portion. Fry one after the other.

Setting Procedure

Select the appropriate temperature setting from the table. Place the empty cooking vessel on the cooking zone.

1. Use the control knob to select the temperature setting you require. Temperature settings 1 to 5 are available for this function; see temperature settings table.

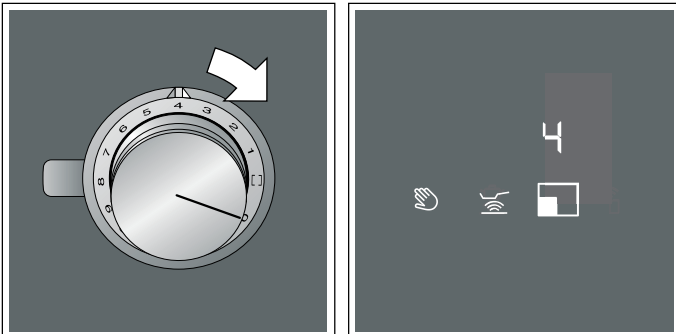



2. Touch the  symbol; it will be lit orange.

The  display and the temperature setting you have selected will be lit.



The function has now been activated.

The , , or  temperature indicator and the temperature setting you have selected will remain lit until the frying temperature has been reached. An audible signal will then sound, and the temperature indicator will go out.

3. Once the frying temperature has been reached, add the fat and then the food to the pan.

Notes

- If a temperature setting above 5 is selected, the setting will automatically be set to 5. In this case, turn the control knob to position 5.
- Turn the food so that it does not burn.

Switching Off the Frying Sensor

Turn the control knob that was used to select the temperature to the 0 position. The cooking zone will switch off, and the residual heat indicator will appear.

Locking the Control Panel for Cleaning

If you wipe over the control panel while the cooktop is switched on, settings may be changed. To avoid doing this, you can use the cooktop's "Lock control panel for cleaning" function.

To switch on: Touch the  symbol. An audible signal sounds. The indicators for the active functions will flash. The control panel is locked for 10 minutes. You will now be able to clean the surface of the control panel without altering the settings.

Switching off: Within the next 10 minutes, touch the  symbol again.

If the function does not deactivate during these 10 minutes, the cooking field switches off.

Notes

- The locking function does not affect the control knobs. The cook-top can be switched off at any time.
- While the locking function is active, the power supply to the cooktop is disconnected. The cooking zones may still be hot.

Basic Settings

The appliance has various basic settings. These basic settings can be altered to suit your individual requirements.

Notes

- The *c5*, *c6*, *c7* and *c8* settings are only displayed if the appliance is connected to an extractor hood.
- The *c7* and *c8* settings are only displayed if the appliance is connected to an extractor hood with lighting.

Display	Function
<i>c1</i>	Signal tones
<i>ON</i>	All signal tones activated.*
<i>OFF</i>	Only fault signal activated.
<i>c2</i>	Power management function. Limit the total power of the cooktop (watts)
<i>OFF</i>	Deactivated.*
<i>1000</i>	Lowest setting
<i>1500</i>	
<i>2000</i>	
...	
<i>9500</i>	Highest setting on the cooktop
<i>c3</i>	Check cookware; cooking results
<i>0</i>	Not suitable
<i>1</i>	Not ideal
<i>2</i>	Suitable
<i>c4</i>	Restore to standard settings
<i>OFF</i>	Individual settings.*
<i>ON</i>	Restore factory settings.
<i>c5</i>	Automatic fan switch-on
<i>OFF</i>	Switched off.
	The extractor hood must be switched on manually, if required.
<i>A</i>	Switched on in automatic mode.*
	In automatic mode, the extractor hood switches itself on when you switch on one of the cooking zones.
<i>1/2/3</i>	Switched on in manual mode.
	The extractor hood switches itself on at a fixed fan setting when you switch on any of the cooking zones.
<i>c6</i>	Fan run-on

* Basic setting

Display	Function
OFF	The fan switches itself off when the cooktop is switched off. Not recommended for the extractor hood in air circulation mode
F	Fan run-on in automatic mode.*
00	Fan run-on with the most recently selected setting.
c 7 Automatic switch-on of extractor hood lighting	
OFF	Switched off.*
00	Switched on. The light switches itself on when you switch on the cooktop.
c 8 Automatic switch-off of extractor hood lighting	
OFF	Switched off.* The light switches itself off when you switch off the cooktop.
00	Switched on. The light switches itself on when you switch off the cooktop.
F 00	Switched on. The light switches itself on when the fan runs on and goes out when the fan run-on time ends.

* Basic setting

Access the Basic Settings

The cooktop must be switched off.

- Carry out the following operating steps one after the other without interruption.
- Push in one of the control knobs and turn it anti-clockwise to >>>. Keep the control knob pressed in.
- Turn the control knob clockwise to position 1. Keep the control knob pressed in.
- Turn the control knob anti-clockwise to position 0.
The  symbol will be lit. The illuminated ring around the control knob will be lit yellow.

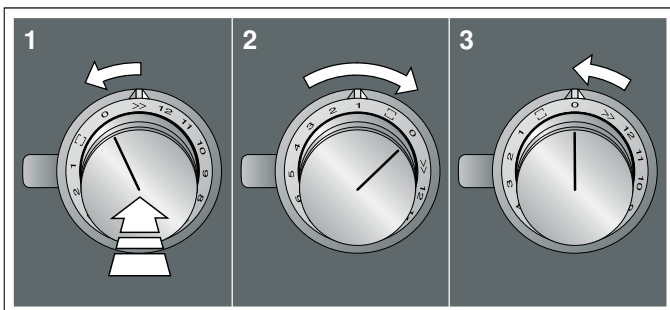

- Touch the  symbol.

The displays show the product information.

Product information	Display
Customer service index (CSI)	01
Production number	Fd
Production number 1	95.
Production number 2	05

- Press the  symbol again to call up the basic settings.

In the displays, **c 1** and **00** light up as a presetting.

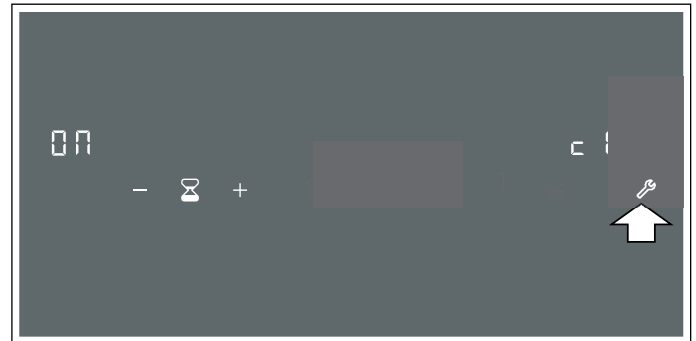

- Touch the  symbol repeatedly until the required function is displayed.
- Then use the **+** and **-** symbols to select the required setting.

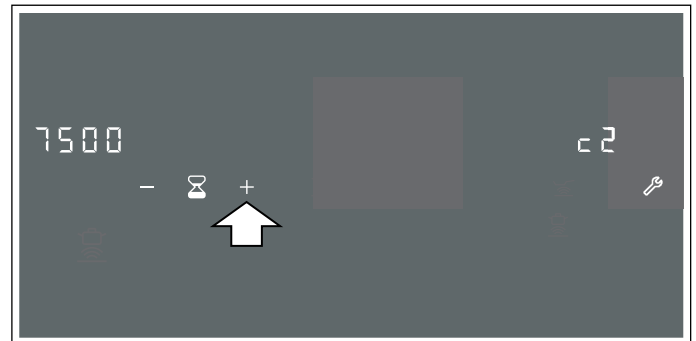

- Touch the  symbol for at least 4 seconds.

The settings have been saved.

Exiting the Basic Settings Menu

- Turn the control knob anti-clockwise to the >>> position.
- Turn the control knob clockwise to position 1.
- Turn the control knob anti-clockwise to position 0.
The  symbol and the illuminated ring around the control knob will go out.

Home Connect

This hob is Wi-Fi-enabled; settings can be sent to the hob via a mobile device.

If the hob is not connected to the home network, the appliance functions in the same way as a hob with no network connection. The hob can always be operated via the control knob.

The availability of the Home Connect function depends on the availability of Home Connect services in your country. Home Connect services are not available in every country. You can find more information on this at www.home-connect.com.

Notes

- Hobs are not designed to be used unattended – you must always keep an eye on the cooking process.
- Ensure that you follow the safety instructions in this instruction manual and that these are also observed when operating the appliance via the Home Connect app. Follow the instructions in the Home Connect app.
- You can use the Home Connect app to change the basic settings for your hob. Remote start or setting a power level is not possible.
- Operating the appliance directly from the appliance always takes priority. It is not possible to operate the appliance using the Home Connect app during this time.

Setting Up

To implement settings via Home Connect, you must have installed and set up the Home Connect app on your mobile device.

Note: In networked standby mode, your appliance requires a maximum of 2 W.

Your appliance must also be connected to the home network (router) and to the Home Connect app (on a mobile device, e.g. a smartphone or tablet).

You can connect your appliance to the home network manually or automatically. Establish the connection to your home network and then the connection to the Home Connect app.

Note: The app will guide you through the entire registration process. In case of doubt, follow the instructions in the app.

Setting up the Home Connect app

Note: You require a mobile device with the latest version of the relevant operating system.

1. On your mobile device, go to the App Store (Apple devices) or to the Google Play Store (Android devices).
2. Enter "Home Connect" in the search field.
3. Select the Home Connect app and install it on your mobile device.
4. Start the app and create your Home Connect login details. The app will guide you through the registration process. Make a note of your e-mail address and password.

Open or close the Home Connect settings menu

To connect your appliance to Home Connect or establish the connection to your home network, you will need to open the Home Connect settings menu on your appliance.

Note: It is important to carry out the following operating steps without interruption, one after the other.

1. Push in any control knob and turn one notch anti-clockwise to the >> position. Keep the control knob pressed in.
2. Turn the control knob two notches clockwise to position □ or ∩. Keep the control knob pressed in.
3. Turn the control knob one notch anti-clockwise to position 0.

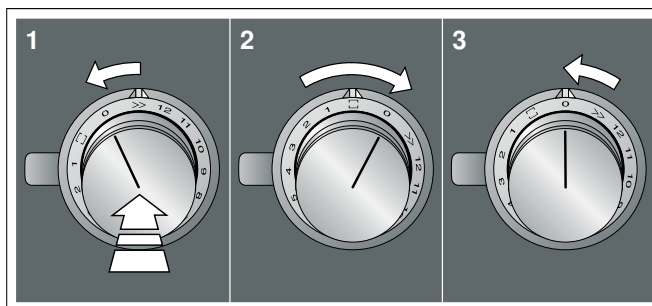

Note: If you select settings in the Home Connect settings menu, you will need to exit the Home Connect menu in the same way to save the settings.

Displays on the illuminated ring on the control knob

- While you are in the Home Connect menu, the illuminated ring on the control knob lights up blue.
- While the appliance is establishing a connection to the home network, the illuminated ring on the control knob flashes blue.
- If the appliance has established a connection to the home network, the illuminated ring on the control knob lights up green.

- If the appliance was not able to establish a connection to the home network, the illuminated ring on the control knob lights up red. Start the connection process again.

Overview of the Home Connect settings menu

- Manually logging in to the home network (Wi-Fi): To log in to the home network (Wi-Fi) manually, you require the network name (SSID) and password (key) for your home network. → *"Manual Registration in the Home Network" on page 30*



- Log in to the home network (Wi-Fi) with a WPS-enabled router. → *"Logging in to your home network automatically (WPS)" on page 31*



- Direct connection to a compatible extractor hood. → *"Connecting appliances directly" on page 35*

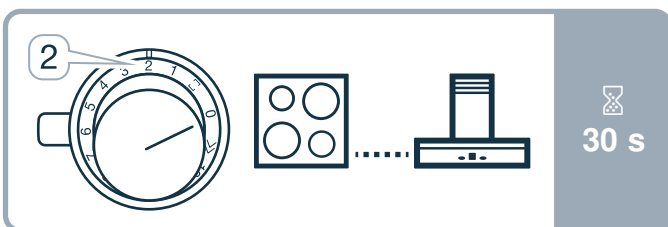

- Switch Wi-Fi off and on, e.g. while on holiday. → *"Switch the wireless network connection (LAN or WLAN) on or off" on page 32*

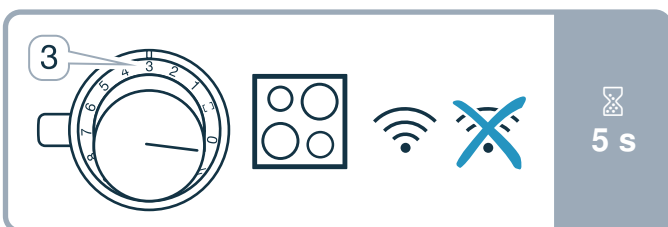

- Reset the Home Connect connections, e.g. for a new router, changing to a new Internet service provider. → *"Resetting the Home Connect connections" on page 33*

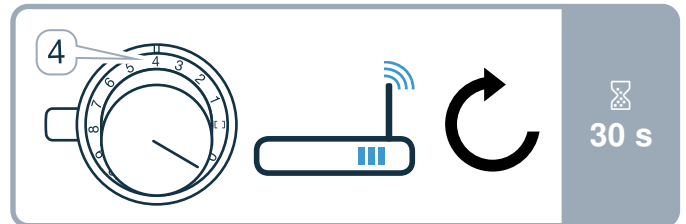

Connecting the appliance to your home network (Wi-Fi)

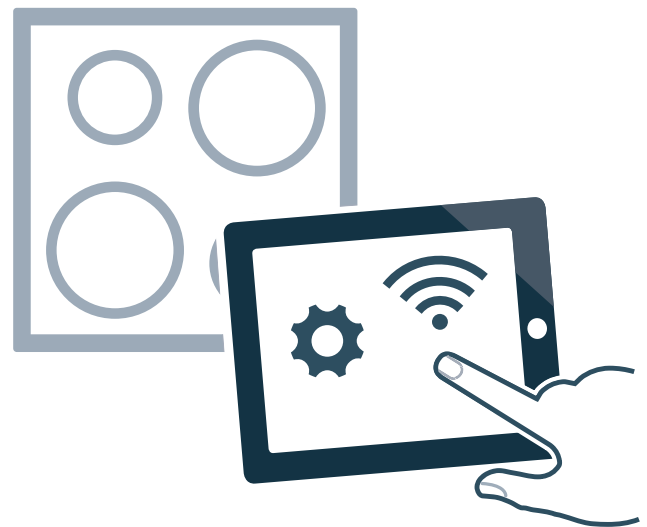

1. Carry out the following operating steps one after the other without interruption.
2. Open the Home Connect settings menu. → *"Open or close the Home Connect settings menu" on page 29*

The illuminated ring around the control knob lights up blue.



Manual Registration in the Home Network

Note: To log in to the home network (Wi-Fi) manually, you require the network name (SSID) and password (key) for your home network.



1. Turn the control knob clockwise to position ☐ or ☐. After around five seconds, the illuminated ring around the control knob flashes blue and yellow alternately. *CON 2* is displayed on the control panel.
The appliance is now in manual mode.

- Switch to the general settings menu of your mobile device and call up the Wi-Fi settings.
On your mobile device, the "HomeConnect" Wi-Fi connection is available for around 20 minutes.
- Connect to the "HomeConnect" Wi-Fi connection (password: "HomeConnect").
- Launch the Home Connect app on your mobile device and follow the instructions for network login. Enter the password (key) of the home network. Following successful connection to the router, the illuminated ring around the control knob lights up green for around three seconds. **PR I** and  are displayed on the control panel.
- The illuminated ring around the control knob flashes blue and white alternately. The connection to the mobile device is being established.
The appliance is available in the app on the mobile device once the illuminated ring around the control knob lights up green. If the illuminated ring around the control knob lights up red, it was not possible to establish a connection.
- To save the connection, exit the Home Connect settings menu. → *"Open or close the Home Connect settings menu" on page 29*

Connection to the router unsuccessful

- If a connection could not be established, check the router and turn the control knob to another position and then back to position  or .
The illuminated ring around the control knob lights up blue. After around five seconds, the illuminated ring around the control knob flashes blue and yellow. **COZ** is displayed on the control panel.
- Switch to the general settings menu of your mobile device and start the Wi-Fi connection again.
- Check that the password has been entered correctly.

Connection to the mobile device unsuccessful



- If a connection could not be established, turn the control knob to another position and then back to position  or .
The illuminated ring around the control knob lights up blue. After around five seconds, the illuminated ring around the control knob flashes blue and white. **PR I** is displayed on the control panel.
- Launch the Home Connect app on your mobile device and follow the instructions for automatic network login.

Connecting more mobile devices to the same Home Connect account

In the Home Connect app, you can connect more mobile devices to your appliance.

Connecting more mobile devices to another Home Connect account

Prerequisite: A mobile device is connected to the appliance. The appliance can be found in the Home Connect settings menu.

- Turn the control knob to another position and then back to position  or .
The illuminated ring around the control knob flashes blue and white. **PR I** is displayed on the control panel. The appliance is now ready to connect to another mobile device.
- Launch the Home Connect app on your mobile device and follow the instructions for automatic network login.
The appliance is available in the app on the mobile device once the illuminated ring around the control knob lights up green.

Logging in to your home network automatically (WPS)

You require a router that has WPS functionality. You will find information about this in the manual for your router. You need to be able to access your router.

If this is not the case, follow the steps in → *"Manual Registration in the Home Network" on page 30.*

- Push in the control knob and turn it to position **1**.
During the connection process, the illuminated ring around the control knob flashes blue and yellow alternately. **COZ** is displayed on the control panel.
- Press the WPS button on the router within the next two minutes.
Following successful connection to the router, the illuminated ring around the control knob lights up green for around three seconds. The illuminated ring around the control knob then flashes blue and white alternately. **PR I** is displayed on the control panel. The appliance is now ready to connect to your mobile device.
- Launch the Home Connect app on your mobile device and follow the instructions for automatic network login.
The appliance is available in the app on the mobile device once the illuminated ring around the control knob lights up green.  is displayed on the control panel. If the illuminated ring around the control knob lights up red, it was not possible to establish a connection.
- To save the connection, exit the Home Connect settings menu.

Connection to the router unsuccessful

1. If a connection could not be established, check the router, and turn the control knob to another position and then back to position 1.

The illuminated ring around the control knob lights up blue. After around five seconds, the illuminated ring around the control knob flashes blue and yellow.

CONN is displayed on the control panel.

2. Switch to the general settings menu of your mobile device and start the Wi-Fi connection again.

Connection to the mobile device unsuccessful

1. If a connection could not be established, turn the control knob to another position and then back to position 1.

The illuminated ring around the control knob lights up blue. After around five seconds, the illuminated ring around the control knob flashes blue and white. **PR** is displayed on the control panel.

2. Launch the Home Connect app on your mobile device and follow the instructions for automatic network login.

Connecting more mobile devices to the same Home Connect account

In the Home Connect app, you can connect more mobile devices to your appliance.

Connecting more mobile devices to another Home Connect account

Prerequisite: A mobile device is connected to the appliance. The appliance can be found in the Home Connect settings menu.

1. Turn the control knob to another position and then back to position 1.

The illuminated ring around the control knob flashes blue and white. **CONN** is displayed on the control panel. The appliance is now ready to connect to another mobile device.

2. Launch the Home Connect app on your mobile device and follow the instructions for automatic network login.

The appliance is available in the app on the mobile device once the illuminated ring around the control knob lights up green.

Exiting the Home Connect settings menu

1. Carry out the following operating steps one after the other without interruption.
2. Close the Home Connect settings menu. → *"Open or close the Home Connect settings menu" on page 29*

The illuminated ring on the control knob goes out.

Switch the wireless network connection (LAN or WLAN) on or off



You can switch off the Wi-Fi on your hob at any time (e.g. to save energy during a holiday). The connections to the home network and to the extractor hood remain saved.

When you switch the Wi-Fi back on, the saved connections are applied.

1. Carry out the following operating steps one after the other without interruption.
2. Open the Home Connect settings menu. → *"Open or close the Home Connect settings menu" on page 29*



The illuminated ring around the control knob lights up blue.

3. Turn the control knob clockwise to position 3. The illuminated ring around the control knob lights up green.

After around five seconds, the illuminated ring around the control knob flashes blue. After a few seconds, the illuminated ring around the control knob lights up blue. The  and  symbols on the control panel go out. Wi-Fi is deactivated.

4. Close the Home Connect settings menu. → *"Open or close the Home Connect settings menu" on page 29*

The illuminated ring on the control knob goes out.

If you want to switch the Wi-Fi back on, run through the same operating sequence. The illuminated ring around the control knob lights up blue. After around five seconds, the illuminated ring around the control knob flashes blue and then lights up green.  and  light up on the control panel.

Note: If the hob is connected directly to a extractor hood, the Wi-Fi cannot be switched off.

Resetting the Home Connect connections

You can reset the connections you have saved for your home network and cooktop at any time.

1. Carry out the following operating steps one after the other without interruption.
2. Open the Home Connect settings menu. → *"Open or close the Home Connect settings menu" on page 29*

The illuminated ring around the control knob lights up blue.

3. Turn the control knob clockwise to position 4.
FE5 lights up on the control panel. After around 30 seconds, the illuminated ring around the control knob lights up green and *DONE* lights up on the control panel. All Home Connect settings have been reset. The appliance will no longer be displayed in the Home Connect app.
4. Close the Home Connect settings menu. → *"Open or close the Home Connect settings menu" on page 29*

The illuminated ring on the control knob goes out.

Software Update

Using the software update function, your cooktop's software can be updated (e.g. for the purpose of optimization, troubleshooting or security updates). To do this, you need to be a registered Home Connect user, have installed the app on your mobile device and be connected to the Home Connect server.

As soon as a software update is available, you will be informed by the Home Connect app, from which you will also be able to download the update.

Notes

- You can continue to use your cooktop as normal while updates are downloading.
- Depending on your personal settings in the app, software updates can also be set to download automatically.
- We recommend that you install security updates as soon as possible.

Remote Diagnostics

Customer Service can use Remote Diagnostics to access your appliance if you contact them, have your appliance connected to the Home Connect server and if Remote Diagnostics is available in the country in which you are using the appliance

Note: For further information and details about the availability of Remote Diagnostics in your country, please visit the Service/Support section of your local website: www.home-connect.com

Information on Data Protection

When your appliance is connected to a WLAN network that is connected to the Internet for the first time, your appliance transmits the following categories of data to the Home Connect server (initial registration):

- Unique appliance identification (consisting of appliance codes as well as the MAC address of the installed Wi-Fi communication module).
- Security certificate of the Wi-Fi communication module (to ensure a secure data connection).
- The current software and hardware version of your appliance.
- Status of any previous resetting to factory settings.

This initial registration prepares the Home Connect functions for use and is only required when you want to use these Home Connect functions for the first time.

Note: Ensure that the Home Connect functions can be used only in conjunction with the Home Connect app. Information on data protection can be accessed in the Home Connect app.

Declaration of Conformity

Gaggenau Hausgeräte GmbH hereby declares that the appliance with Home Connect functionality meets the basic requirements and other relevant provisions of Directive 2014/53/EU.

A detailed RED Declaration of Conformity can be found online at www.gaggenau.com among the additional documents on the product page for your appliance.



2.4 GHz band: max. 100 mW

5 GHz band: max. 100 mW



BE	BG	CZ	DK	DE	EE	IE	EL
ES	FR	HR	IT	CY	LV	LT	LU
HU	MT	NL	AT	PL	PT	RO	SI
SK	FI	SE	UK	NO	CH	TR	

5 GHz WLAN (Wi-Fi): For indoor use only

Wi-Fi® Module

FCC/IC Statements

Model: COM2
FCC ID: 2AHES-COM2
IC: 21152-COM2

The Home Connect module is a communication device designed to provide communication between appliances and smart devices.

This module is integrated at the factory, under direct control of BSH Home Appliances Corporation, and is not user servicable or upgradable. At least 7⁷/₈ inch (20 cm) separation distance should be maintained from device to user.

FCC COMPLIANCE STATEMENT

CAUTION

Changes or modifications not expressly approved could void your authority to use this equipment.

This device complies with Part 15 of the FCC Rules. Operation to the following two conditions:

1. This device may not cause harmful interference, and
2. This device must accept any interference received, including interference that may cause undesired operation.

INDUSTRY CANADA STATEMENT

This device complies with Industry Canada license-exempt RSS standard(s).

Operation is subject to the following two conditions:

1. This device may not cause interference, and
2. This device must accept any interference, including interference that may cause undesired operation of the device.

Operation in the band 5150-5250 MHz is only for indoor use to reduce the potential for harmful interference to co-channel mobile satellite systems.

Connecting the extractor hood

You can connect this appliance to a compatible extractor hood and control the functions of the extractor hood via your cooktop.

You can connect one extractor hood to one or more cooktops. You cannot connect several extractor hoods to one cooktop.

Notes

- Make sure you follow the safety instructions in the user manual for your extractor hood and that these are complied with even when operating the appliance via the hood controls on the cooktop.
- Operating the extractor hood directly from the extractor hood always takes priority. It is not possible to use the hood controls on the cooktop during this time.
- In networked standby mode, your appliance requires a maximum of 2 W.

You have the following options for connecting the appliances together:

- Connecting appliances via the home network → *"Connecting appliances via the home network" on page 34*
- Connecting appliances directly → *"Connecting appliances directly" on page 35*

Connecting appliances via the home network

If the appliances are connected to each other via your home network, both the hood controls on the cooktop and the Home Connect functions can be used to operate the appliance.

Two appliances can be connected using the Home Connect app provided that both of them are Home Connect-compatible.

Refer to the Home Connect documents supplied for more information.

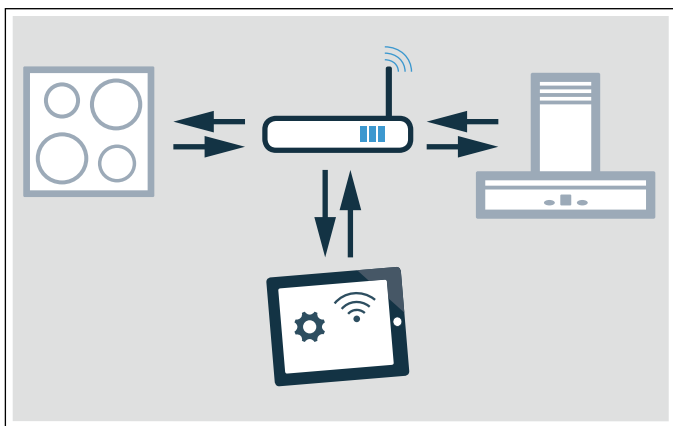

Establishing a connection via the home network

1. Open the Home Connect settings menu. → *"Open or close the Home Connect settings menu" on page 29*
2. Log in to the home network manually or automatically; see → *"Manual Registration in the Home Network" on page 30* or → *"Logging in to your home network automatically (WPS)" on page 31.*

Once the cooktop is connected to your home network, you can connect to the extractor hood via the Home Connect app. To do this, follow the instructions on your mobile device.

Connecting another cooktop to the extractor hood

1. Connect both cooktops to Home Connect. → *"Manual Registration in the Home Network" on page 30* or → *"Logging in to your home network automatically (WPS)" on page 31*
2. Connect the extractor hood to Home Connect. Follow the instructions in the user manual for your extractor hood.
3. In the Home Connect app, connect the first cooktop to the extractor hood.
4. In the Home Connect app, connect the second cooktop to the extractor hood.

Connecting appliances directly

If the appliance is connected directly to an extractor hood, it cannot be connected to your home network as well. The appliance functions in the same way as a cooktop with no network connection and can still be operated via the control panel.

Before connecting the appliances, reset all existing connections to your home network or other appliances.

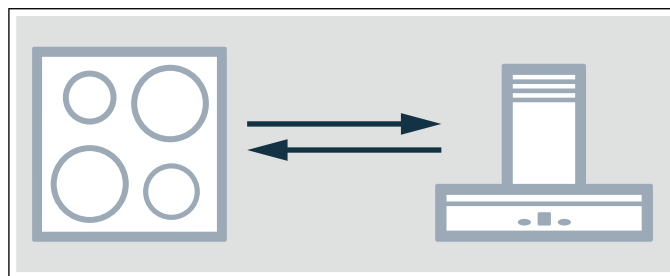

Establishing a direct connection

Make sure that the extractor hood is switched on and is in search mode. Search mode means that the connection process on the extractor hood has been started.

Refer to your extractor hood's user manual for more information.

1. Open the Home Connect settings menu. → *"Open or close the Home Connect settings menu" on page 29*
2. Turn the control knob clockwise to position **2**.
After around 5 seconds, the illuminated ring around the control knob flashes blue and yellow alternately. **HH** is displayed on the control panel. The cooktop is connected to the extractor hood once the illuminated ring on the control knob permanently lights up green.
3. Close the Home Connect settings menu. → *"Open or close the Home Connect settings menu" on page 29*

The illuminated ring on the control knob goes out.

Direct connection unsuccessful

If, after around 30 seconds, a connection could not be established, the illuminated ring around the control knob lights up red. Turn the control knob to another position and then back to position **2**.

The illuminated ring around the control knob lights up blue. After around 5 seconds, the illuminated ring around the control knob flashes blue and yellow. The appliance is trying to establish a connection again.

Connecting another cooktop to the extractor hood

In order to connect another cooktop to the extractor hood, run through the direct connection again with the second cooktop.

Controlling the extractor hood via the cooktop

In the Home Connect app, you can adjust the behavior of your extractor hood depending on whether the cooktop or individual cooking zones are switched on or off.

Cleaning and Maintenance

Daily Cleaning

Note: Recommended cleaners indicate a type of cleaner and do not constitute an endorsement of a specific brand.

Glass Ceramic Cooktop

CAUTION

Do not use any kind of cleaner on the glass while the surface is hot; use only the razor blade scraper. The resulting fumes can be hazardous to your health. Heating the cleaner can chemically attack and damage the surface.

Clean the surface when it is completely cool, with the following exception: remove dry sugar, sugar syrup, tomato products and milk immediately with the razor blade scraper (see cleaning chart).

Wipe off spatters with a clean, damp sponge or a paper towel. Rinse and dry. Use white vinegar if smudge remains; rinse.

Apply a small amount of the glass ceramic cooktop cleaner. When dry, buff surface with a clean paper towel or cloth.

Stainless steel side trim

Use a cleaning pad for this piece. For moderate or heavy soil, use a powder cleaner such as BonAmi® or SoftScrub® (without bleach).

Wipe using a damp sponge or cloth, rinse and dry.

Control knob

Wipe with warm soapy cloth, rinse and dry.

Wok Support

The wok support should not be cleaned in the dishwasher.

Cleaning Guidelines

When using a cleaner, use only a small amount; apply to a clean paper towel or cloth. Wipe on the surface and buff with a clean dry towel.

For best results, use cleaners such as glass ceramic cooktop cleaner, BonAmi®, Soft Scrub® (without bleach), and white vinegar.

Avoid these Cleaners

- Glass cleaners which contain ammonia or chlorine bleach. These ingredients may damage or permanently stain the cooktop.
- Caustic cleaners - cleaners such as Easy Off® may stain the cooktop surface.
- Abrasive cleaners.
- Metal scouring pads and scrub sponges such as Scotch Brite® can scratch and/or leave metal marks.
- Soap-filled scouring pads such as SOS® can scratch the surface.
- Powdery cleaners containing chlorine bleach can permanently stain the cooktop.
- Flammable cleaners such as lighter fluid or WD-40.

Cleaning Chart

Type of Soil	Possible Solution
Dry sugar, sugar syrup, milk or tomato spills. Melted plastic film or foil. All these items REQUIRE IMMEDIATE REMOVAL. Failure to remove these immediately can permanently damage the surface.	Remove these types of spills while the surface is hot using the razor blade scraper. Use a new, sharp razor in the scraper. Remove pan and turn off the cooking zone. Wearing an oven mitt, hold scraper at 30° angle, using care not to gouge or scratch the glass. Push soil off the heated area. After the surface has cooled, remove the residue and apply the glass ceramic cooktop cleaner.

WARNING

Risk of injury!

The blade is extremely sharp. Risk of cuts. Protect the blade when not in use. Replace the blade immediately when any imperfections are found. Follow manufacturer's instructions.

Burned-on food soil, dark streaks, and specks

Soften by laying a damp paper towel or sponge on top of soil for 30 minutes. Use a plastic scrubber and glass ceramic cooktop cleaner or use the razor blade scraper. Rinse and dry.

Type of Soil	Possible Solution
Greasy spatters	Use a soapy sponge or cloth to remove grease; rinse thoroughly and dry. Apply glass ceramic cooktop cleaner.
Metal marks: Iridescent stains	Pans with aluminum, copper or stainless steel bases may leave marks. Treat immediately after surface has cooled with glass ceramic cooktop cleaner. If this does not remove the marks, try a mild abrasive (Bon Ami®, Soft Scrub® without bleach) with a damp paper towel. Rinse and reapply glass ceramic cooktop cleaner. Failure to remove metal marks before the next heating makes removal very difficult.
Hard water spots: Hot cooking liquids dripped on surface	Minerals in some water can be transferred onto the surface and cause stains. Use undiluted white vinegar, rinse and dry. Recondition with glass ceramic cooktop cleaner. Remove boilovers and stains before using the cooktop again.
Surface scratches: Small scratches are common and do not affect cooking. They become smoother and less noticeable with daily use of the glass ceramic cooktop cleaner.	Apply glass ceramic cooktop cleaner before using to remove sand-like grains and grit such as salt and seasoning. Scratches can be reduced by using pans with bases that are smooth, clean, and dry before use. Use recommended glass ceramic cooktop cleaner daily.

NOTICE

Avoid contact with surface by jewelry, wrist watches and metallic utensils. These can scratch the surface. Do not stack kitchen utensils or dishware on the appliance.

Maintenance

This appliance requires no maintenance other than daily cleaning. For best results, apply cooktop cleaning cream daily.

FAQ

Noises

Why can I hear noises while I'm cooking?

Noises may be generated while using the cooktop depending on the base material of the cookware. These noises are normal for induction technology. They do not indicate a defect.

Possible noises:

A low humming noise like the one a transformer makes:

Occurs when cooking at a high heat setting. The noise disappears or becomes quieter when the heat setting is reduced.

Low whistling noise:

Occurs when the cookware is empty. The noise disappears when water or food is added to the cookware.

Crackling:

Occurs when using cookware made from layers of different material or when using cookware of different sizes and different materials at the same time. The volume of the noise can vary depending on the quantity of food being cooked or the cooking method.

High-pitched whistling noises:

Can occur when two cooking zones are used on the highest heat setting at the same time. The whistling noises disappear or become quieter when the heat setting is reduced.

Fan noise:

The cooktop is equipped with a fan that switches on automatically at high temperatures. The fan may continue to run even after you have switched off the cooktop if the temperature detected is still too high.

Cookware

Which types of cookware can be used with an induction cooktop?

You can find information on which types of cookware can be used with an induction cooktop in the section → *"Cooking with induction"*

Why is the cooking zone not heating up and why is the heat setting flashing?

The cookware is on a different cooking zone the one that has been switched on.

Make sure that you have switched on the cooking zone on which the cookware is standing.

The cookware is too small for the cooking zone that is switched on or it is not suitable for induction cooking.

Check that the cookware is suitable for induction cooking and that it is placed on the cooking zone that best corresponds to its size. You can find information on the type, size, and positioning of the cookware in the sections → *"Suitability Test of Cookware"* and

Why is it taking so long for the cookware to heat up or why is it not heating up sufficiently despite being on a high heat setting?

The cookware is too small for the cooking zone that is switched on or it is not suitable for induction cooking.

Check that the cookware is suitable for induction cooking and that it is placed on the cooking zone that best corresponds to its size. You can find information on the type, size, and positioning of the cookware in the sections → *"Suitability Test of Cookware"* and

Cookware

How do you switch on the two-ring and three-ring cooking zones?

These cooking zones can detect cookware of different sizes. The cooking zone automatically activates the one-, two-, or three-ring cooking zone, depending on the material and characteristics of the cookware. This ensures that the right amount of heat is supplied in order to achieve good cooking results.

Cookware that corresponds to the size of the cooking zone and has a fully ferromagnetic base is most suitable. You can find information on which types of cookware can be used with an induction cooktop in the section → *"Cooking with induction"*

Cleaning

How do I clean the cooktop?

Using a special glass-ceramic cleaning agent produces the best results. We advise against using harsh or abrasive cleaning agents, dishwasher detergent (concentrated) or scouring pads.

You can find more information about cleaning and caring for your cooktop in the section on → *"Cleaning and Maintenance"*

Faults – what to do?

Generally, faults are easy to remedy. Please read the notes in the table before calling Customer Service.

Display	Possible cause	Remedial action
None	The power supply has been disconnected. The device has not been connected according to the circuit diagram. Electronic fault.	Use other electrical appliances to check whether a short-circuit has occurred in the power supply. Check that the appliance has been connected as shown in the circuit diagram. If the fault cannot be rectified, inform the technical after-sales service.
An audible signal sounds.	The control panel is damp or an object is covering it.	Dry the control panel or remove the object.
The cooking zone has been switched off. The illuminated ring on the control knob is flashing.	The control knob has not been turned for an extended period.	Turn the control knob to the 0 position. Switch the cooking zone back on.
	The appliance is too hot.	Read the fault message on the control panel.
The cooking zone display is flashing.	The cookware is not detected. Ensure that the cookware is suitable for induction cooking.	Ensure that the diameter of the base of the cookware corresponds to the size of the cooking zone. Turn the control knob to the 0 position. Switch the cooking zone back on.
<i>F2</i>	The electronics have overheated and the corresponding cooking zone has been switched off.	Remove any cookware from the cooking zone. When the fault code goes out, the cooking zone has cooled down sufficiently. Turn the control knob to the 0 position. Then select the heat setting as usual.
<i>F4</i>	The electronics have overheated and all cooking zones have been switched off.	
<i>F5</i> + heat setting and audible signal	There is hot cookware near the control panel. There is a risk that the electronics will overheat.	Remove the cookware. The fault display goes out shortly afterwards. You can resume cooking.
<i>F5</i> and audible signal	There is hot cookware near the control panel. To protect the electronics, the cooking zone has been switched off.	Remove the cookware. Wait a few seconds. When the fault code on the display goes out, you can resume cooking.
<i>F1 / F6</i>	The cooking zone has overheated and has been switched off to protect the work surface.	Wait until the electronics have cooled down sufficiently before switching the cooking zone on again.
<i>F8</i>	The cooking zone was operating for an extended period without interruption.	Turn the control knob to the 0 position. Switch the cooking zone back on.
<i>E9000</i> <i>E90 10</i>	The supply voltage is faulty/outside of the normal operating range.	Contact your energy provider.
<i>U400</i>	The cooktop is not connected properly	Disconnect the cooktop from the power supply. Check that the appliance has been connected as shown in the circuit diagram.
Do not place hot cookware on the control panel.		

Notes

- If the fault code is not listed in the table, disconnect the cooktop from the power supply, and wait 30 seconds before reconnecting it. If this code appears again, contact technical Customer Service,

and specify which fault code has appeared.

- If a fault occurs, the appliance will not switch to standby mode.

Demo Mode

If **DE ON** is displayed, demo mode has been activated. The appliance will not heat up. Disconnect the appliance from the power supply. Wait 30 seconds before reconnecting it. Then deactivate the demo mode within three minutes as follows:

1. Turn one of the control knobs anti-clockwise to position **>>**.
2. Turn the same control knob clockwise to position 1.
3. Turn the same control knob anti-clockwise to position 0.

The illuminated ring around the control knob will be lit yellow.

4. Turn the same control knob clockwise to position 1. The **ON** display will be lit and the illuminated ring will be green.

Wait for five seconds. The **OFF** display will be lit and the illuminated ring will turn yellow.

Demo mode has now been deactivated.

Suitability Test of Cookware

This function can be used to check the speed and quality of the cooking process depending on the cookware.

The result is a reference value and depends on the properties of the cookware and the cooking zone being used.

1. Fill the pan with approx. 8 oz. (200 ml) of water, and place it at room temperature in the middle of the cooking zone that most closely matches the diameter of the pan base.
2. Go to the basic settings, and select the **c 3** setting. The **OFF** indicator lights up.
3. Touch the **+** or **-** symbol. The **ON** display will be lit. A signal tone will sound and the cooking zone indicators will be lit.

The function has now been activated.

The **FUN** display will be lit. After a few seconds, the cooking zone displays will show the results for the quality and speed of the cooking process.

Check the result using the table below:

Result	
0	The cookware is not suitable for the cooking zone and will therefore not heat up.*
1	The cookware is taking longer to heat up than expected and the cooking process is not going as well as it ought to.*
2	The cookware is heating up correctly and cooking is progressing well.

* If there is a smaller cooking zone available, try the cookware again on the smaller cooking zone.

To activate the function again, touch the **+** or **-** symbol.

Notes

- Do not use the wok or wok accessories with this function.
- The flex cooking zone is set to function as a single cooking zone; only test one item of cookware at a time on it.
- If the diameter of the cooking zone that is used is much smaller than the diameter of the cookware, only the middle of the cookware can be expected to heat up. This may result in the cooking results not being as good as expected or being less than satisfactory.
- You can find information about this function in section → *"Basic settings"*
- You can find information on the type, size, and positioning of the cookware in the sections entitled and → *"Flexible cooking zone"*.

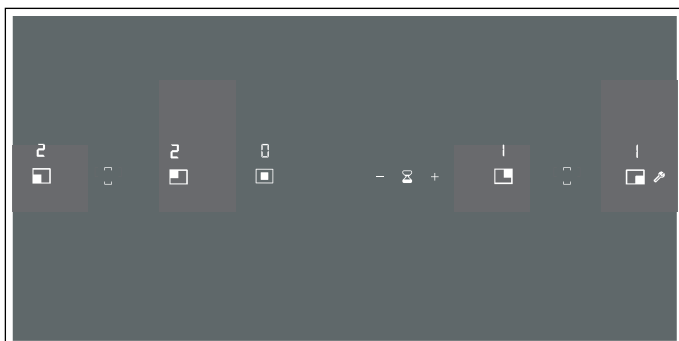

Customer Service

If your appliance needs repairs, our Customer Service is there for you. We work hard to help solve problems quickly and without unnecessary service calls, getting your appliance back up and running correctly in the least amount of time possible.

When you call, please indicate the product number (E-Nr.) and serial number (FD-Nr.) so that we can support you in a qualified manner. You will find the data plate with these numbers on the bottom of the appliance. To avoid having to search when you need it, you can enter your appliance data and the Customer Service telephone number here.

E-Nr.

FD-Nr.

Customer Service 

Please read the use and care instructions provided with your appliance. Failure to do so may result in an error in using the appliance resulting in unnecessary service calls, which may not be covered by the warranty.

Please find the contact data of all countries in the enclosed customer service list.

To book a service visit and product advice

USA 877 442 4436
toll-free

CANADA 877 442 4436
toll-free

BSH Home Appliances Corporation
1901 Main Street, Suite 600
Irvine, CA 92614
USA
www.gaggenau.com
1-877-442-4436
© 2022 BSH Home Appliances Corporation

GAGGENAU



9001475240 en-us (021024)