

FISHER & PAYKEL

**INTEGRATED
WINE CABINET**



24" INTEGRATED

RS2484VL2K1 & RS2484VR2K1

USER GUIDE

US CA

CONTENTS

Safety and warnings	4
Integrated wine cabinet	8
Storage features	9
Control panel	10
ActiveSmart™ special features	11
Wifi connection	12
Using your appliance	13
Loading your wine bottles	16
Wine care	17
Replacing carbon filter	18
Cleaning care — exterior	19
Cleaning care — interior	20
User warnings and sounds	22
Troubleshooting	23
Service & warranty	25

Registration

To register your product visit our website: fisherpaykel.com/register

SAFETY AND WARNINGS

WARNING!



Electric Shock Hazard

Failure to do so can result in death, electric shock, fire or injury to persons.

- Read and follow the safety and warnings outlined in this user guide before operating this appliance.

WARNING!



R600a

This appliance contains flammable refrigerant isobutane (R600a).

SAFETY AND WARNINGS

READ AND SAVE THIS GUIDE

WARNING!

Read entire manual. Failure to follow all guides and rules could cause personal injury or property damage. When using this appliance always exercise basic safety precautions including the following:

General Use

- This product has been designed for use in a normal domestic (residential) environment.
- Children should be supervised to ensure that they do not play with the appliance.
- Cleaning and user maintenance shall not be undertaken by children without supervision.
- This appliance can be used by children aged from 8 years and above and persons with reduced physical, sensory or mental capabilities or lack of experience and knowledge if they have been given supervision or instruction concerning use of the appliance in a safe way and understand the hazards involved.
- The manufacturer's installation instructions for product and cabinetry ventilation must be followed when installing the appliance.
- To avoid hazard due to instability of the appliance, it must be fixed in accordance with installation instructions.
- Keep ventilation openings, in the appliance enclosure or the built-in structure, clear of obstruction.
- Do not use mechanical devices or other means to accelerate the defrosting process, other than those recommended by the manufacturer.
- Do not damage the refrigerant circuit.
- In case of damage to the refrigerant circuit, ventilate the area by opening all windows.
- Do not operate electrical equipment or any other equipment that may produce arcs, sparks or flames in the area. Contact your Fisher & Paykel trained and supported service technician immediately to arrange for the appliance to be repaired.
- It is hazardous for anyone other than a Fisher & Paykel trained and supported service technician to service this appliance.
- Connect to potable water supply only.
- This refrigerating appliance is intended to be used at ambient temperatures ranging from 61 °F (16 °C) to 100 °F (38 °C).
- For optimum performance, it is recommended to control the ambient temperature between 61 °F (16°C) and 77 °F (25°C).

Electrical

- This appliance must be installed in accordance with the installation instructions before use.
- To allow disconnection of the appliance from the supply after installation, incorporate a switch in the fixed wiring in accordance with the wiring rules.
- Never unplug your Wine Cabinet by pulling on the power cord. Always grip the plug firmly and pull straight out from the outlet.
- Do not plug in any other appliance at the same power point as your Wine cabinet or use extension cords or double adapters.
- Repair or replace immediately all electric service cords that have become frayed or otherwise damaged. Do not use a cord that shows cracks or abrasion along its length or at either the plug or appliance end.
- If the power supply cord is damaged, it must only be replaced by your Fisher & Paykel trained and supported service technician because special purpose tools are required.

SAFETY AND WARNINGS

- When moving your appliance away from the wall, be careful not to roll over or damage the power cord.
- **WARNING:** Do not use electrical appliances inside your appliance, unless they are of the type recommended by the manufacturer.
- When positioning the appliance, ensure the power cord is not trapped or damaged.
- Do not locate multiple portable socket-outlets or portable power supplies at the rear of the appliance.

Food safety

- This appliance is intended to be used exclusively for the storage of wine.
- Do not store food and milk products in the Wine Cabinet. The interior temperature may not be cool enough to prevent spoilage in food, and the expiry dates stated on the food packaging may be invalid.

Storage

- Do not store explosive substances such as aerosol cans with a flammable propellant in this appliance.
- Never store volatile or flammable materials in your appliance as they may explode.

Servicing

- Your refrigerator is designed to operate for many years without the need for service checks. However, if your refrigerator is malfunctioning, have it attended to by your Fisher & Paykel trained and supported service technician as soon as possible. All electrical repairs must be carried out by an adequately trained service technician or qualified electrician.
- The LED light cannot be serviced by the user. Contact your Fisher & Paykel Dealer or Fisher & Paykel trained and supported service technician.

Cleaning

- Use only soap based cleaning products.
- Use a clean microfiber cloth for cleaning the wooden racks. Do not use liquid/water on oak racks. Ensure the racks are not too wet.
- Avoid using anti-bacterial cleaning products on either the interior or exterior of the cabinet as they may cause rusting of metal components and cracking of plastic components.

Disposal

- Extreme care must be taken when disposing of your old appliance to avoid hazards:
- The flammable refrigerant gas must be safely removed by a qualified service technician.
- The thermal insulation foam in this appliance may contain flammable insulation blowing gases, any exposed foam may be highly flammable and must be carefully treated during disposal.
- **WARNING:** Risk of child entrapment. Before you throw away your old appliance, the doors and panels should be removed and the racks left in place so that children may not easily climb inside.
- Consult your local energy authority or local codes as to the best way to dispose of your old appliance.

SAFETY AND WARNINGS

WARNING!

To reduce the risk associated with choking:

- DO NOT allow children under 3 years of age to have access to small parts during the installation of the water filter.

Power failure

- In the event of a power interruption, the Wine Cabinet will automatically save the current temperature settings. When power is recovered, the Wine Cabinet will revert to the current temperature settings only.
- Most power failures are corrected within a short period of time. 1 - 2 hours loss of power will not affect the Wine Cabinet's temperatures.
- To avoid sudden change of temperature while power is off, you should avoid opening the door. For longer periods of power failure, do take steps to protect your wine.

IMPORTANT!

This device complies with part 15 of the FCC Rules. Operation is subject to the following conditions:

- This device may not cause harmful interference.
- This device must accept any interference received, including interference that may cause undesired operation.

Do not change or modify the wireless communication device in any way. Changes or modifications not expressly approved by Fisher & Paykel could void the user's authority to operate the equipment.

WARNING: The incorporated Wi-Fi module in this appliance is to operate only from channel 1 to channel 11 as per FCC rules.

This device contains licence-exempt transmitter /receiver that comply with Innovation, Science and Economic Development Canada's licence-exempt RSS(s). Operation is subject to the following two conditions:

- This device may not cause interference.
- This device must accept any interference, including interference that may cause undesired operation of the device.

INTEGRATED WINE CABINET

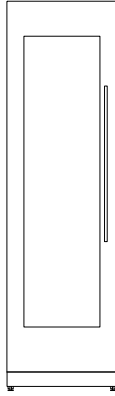

24" Wine Cabinet

RS2484VL2K1

Left hinge

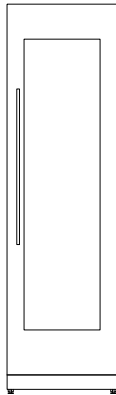

24" Wine Cabinet

RS2484VR2K1

Right Hinge

STORAGE FEATURES

Integrated Wine Cabinet

Easy-clean design with evenly distributed lighting and aluminum trims.

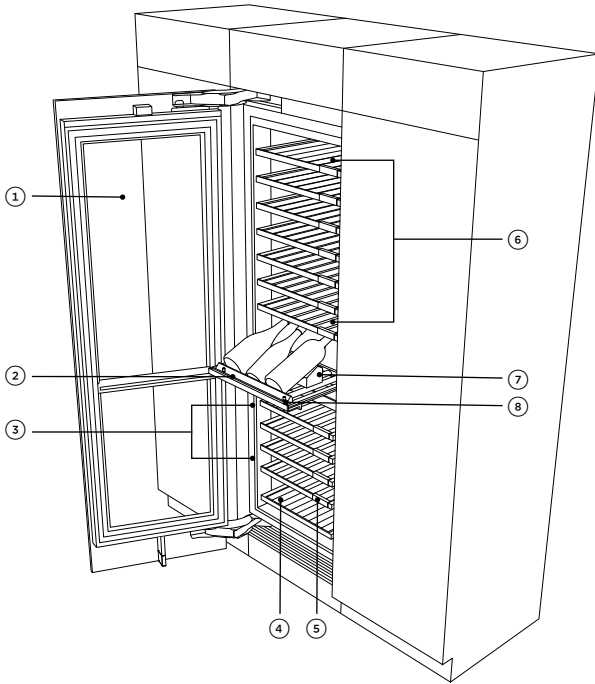

Cabinet features

- ① UV tempered glass door
- ② Display handle
- ③ Interchangeable Lower bottle racks
- ④ Bulk storage rack
- ⑤ Wine bottle labels
- ⑥ Interchangeable Upper bottle racks
- ⑦ Display cradles
- ⑧ Display rack







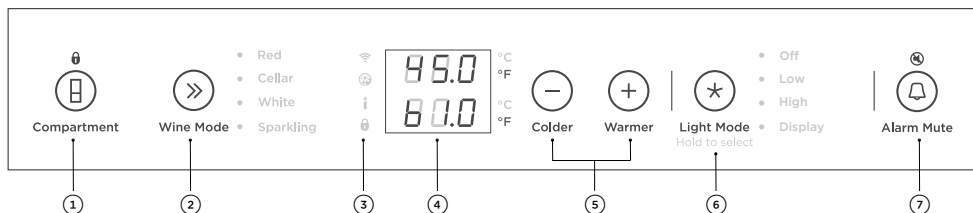

WINE CABINET COMPONENTS

Bottle racks	Removable bottle racks (white oak)*
Accessories	Wine display kit Wine label kit

* Racks may be different sizes. Ensure you have the correct dimensions when replacing racks,

CONTROL PANEL



- ① Allows you to unlock the control panel and enable compartment selection. Press  for 4 seconds to activate your appliance for the first time. The control panel will automatically lock when inactive for more than 10 seconds or when the door is closed. To unlock, press  for two seconds.
- ② Allows you to select the wine mode for the selected compartment.
- ③  Illuminates to show wireless remote mode is enabled.
 Illuminates to indicate that Sabbath mode is activated.
 Illuminates to indicate that the keys on the control panel are locked. When the door is closed the display is automatically locked.
 Illuminates to indicate that carbon filter replacement is required.
- ④ Displays the set temperature of the compartments. To change between Celsius and Fahrenheit on the display:
 - Press  and  together for four seconds.
- ⑤ Allows you to adjust the temperature of the selected compartment.
- ⑥ Allows you to select the light mode for the selected compartment.
- ⑦ Deactivates the door alarm for 20 minutes.

ACTIVESMART™ SPECIAL FEATURES

Variable temperature zones

The serving temperature of your wine is crucial for your taste and enjoyment, therefore 'Wine Modes' have been carefully designed to both care for your wine and provide the ideal serving temperature for all wine varieties.

The separate modes allow you to adjust the temperature in both compartments independently.

Not all wines will improve over time. Check with your wine merchant for more information regarding the best storage conditions for your wine.

WINE MODES		TYPES OF WINE TO STORE
Red (16°C/61°F)	'Red Mode' is suitable for short term storage of light, fruity and full-bodied reds at serving temperature.	Pinot Noir, Merlot, Malbec, Shiraz/Syrah, Chianti, Cabernet Sauvignon, Vintage Port.
Cellar (12°C/54°F)	For longer term storage of all wine varieties, 'Cellar Mode' provides conditions suitable for aging wines.	All varieties.
White (8°C/46°F)	'White Mode' is suitable for short term storage of aromatic white wines and Rose at serving temperature.	Sauvignon Blanc, Chardonnay, Riesling, Pinot Gris, Viognier, Chablis, Gewürztraminer, Rosé.
Sparkling (7°C/45°F)	'Sparkling Mode' is suitable for short term storage of all sparkling wines at serving temperature.	Sparkling wines (eg Méthode Champenoise, Metodo Classico) Champagne, Cava, Prosecco.

Light modes

Four Light Modes are available to choose from. Select a Light Mode that suits the desired illumination of bottles as well as the surrounding environment.

WINE MODES	
Off	Select "Off" to turn off all compartment lights.
Low	The dimmest setting available; softly illuminating the interior of your Integrated Wine Cabinet while allowing it to blend into the surrounding environment.
Display	Brightly illuminates bottles on the display rack while all other racks remain dimly lit, bringing emphasis to those extra special bottles.
High	Turns all compartment lights to full brightness; the perfect mode for showcasing your wine collection.

WIFI CONNECTION

Your appliance can be connected to your home wireless network and operated remotely using the app.

Getting started

- Ensure your home WiFi network is turned on.
- You will be given step by step guidance on both your appliance and mobile device.
- It may take up to 10 minutes to connect your appliance.

On your mobile device:

- ① Download the app from www.fisherpaykel.com/connect
- ② Register and create an account.
- ③ Add your appliance and set up the WiFi connection.

USING YOUR APPLIANCE

Temperature control

At initial startup, each **WINE MODE** will automatically default to the recommended temperature setting. Once you have selected the compartment and required **WINE MODE**, the temperature can be adjusted as desired. The selected setting will be saved for future use.

» Selecting the Wine Mode



Select the desired compartment.

Press » to scroll through the available modes. The light next to the name of the **WINE MODE** will illuminate as you scroll to indicate which mode is selected.

Adjusting the temperature

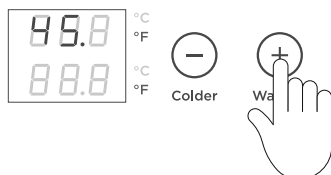

Press + to increase the temperature of the selected food mode.

Press - to decrease the temperature of the selected food mode.

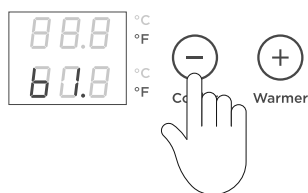

USING YOUR APPLIANCE

★ Selecting the Light Mode

1



To activate a Light Mode:

Press ★ repeatedly to scroll through the available **LIGHT MODE** settings and select your preferred mode.

Press ★ for two seconds to activate.

A blinking light indicates the current position when scrolling through the list.

To deactivate a Light Mode:

Press ★ for two seconds to deactivate.

When opening the door of your product, all internal lights will illuminate to full brightness. Upon closing the door, your appliance will remember the previously selected **LIGHT MODE**

Note: 'Display' and 'High' modes will default to 'Low' after a set duration. For longer term storage, we recommend turning your lights to **OFF**.

🔒 Key lock

Allows you to disable the buttons on the control panel. Suitable when cleaning your appliance.

1



To activate:

Press  for two seconds. The  icon on the control panel will illuminate.

2



To deactivate:

Press  for two seconds. The  icon will dim.



USING YOUR APPLIANCE

Alarm mute

1



To activate:

To activate, press  once. The  will illuminate to indicate the refrigerator is muted.

ALARM MUTE will deactivate after 20 minutes. Press  to deactivate manually. Closing the door also deactivates the **ALARM MUTE**.

Door alarm

- If the door is left open, the alarm will beep after 90 seconds.
- If the door remains open, subsequent beeps will sound every 30 seconds for five minutes.
- If the door remains open for five minutes or longer, an alarm will sound continuously and the interior compartment light(s) will turn off.

Key mute

1



To activate:

Press  for two seconds, a single beep will sound to indicate key mute is activated. All key sounds are now muted.

To deactivate:



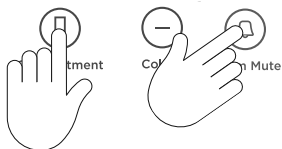

Press  for two seconds, a single beep will sound.

Sabbath mode

1



To activate:

Press ,  and  together for four seconds. The  icon on the control panel will illuminate. When activated, the display, all alarms and lights are deactivated for 80 hours.

To deactivate manually:

Press ,  and  together for four seconds.

Note: If you turn off your appliance while in Sabbath mode, it will resume automatically once the appliance is switched on again.

LOADING YOUR WINE BOTTLES

The Integrated Wine Cabinet has a recommended maximum storage capacity of 91 standard 750ml bottles. The loading arrangement outlined is recommended when using the wine cabinet at full capacity. Racks may be removed to store larger sized bottles, for example Magnums.

DOs

- Before loading wine into the cabinet confirm that all racks are secured and stable.
- Stack wine bottles of same sizes to enable easy access if required.
- Only interlock wine bottles of the same size. This ensures the first tier is stable to allow stacking.
- Follow the recommended loading arrangement outlined for each rack.

DON'Ts

- Do not load more than the recommended number of wine bottles on each rack.
- Do not interlock wine bottles of different sizes that do not fit well together on a rack.
- Do not stack Magnums or larger sized wine bottles.

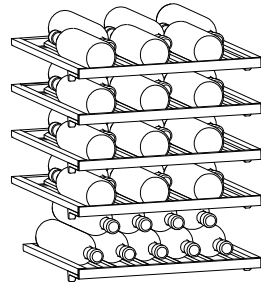
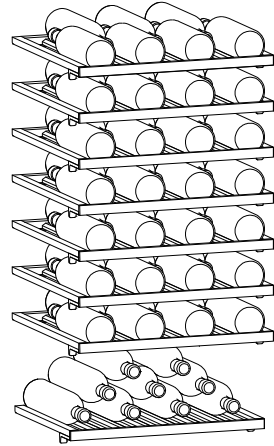

IMPORTANT!

- **When stacking bottles, take extra care to avoid breakages.**
- **A net or vented mat can be used between bottles in a stack to minimise risk of breakage. Alternatively, net sleeves can be used to protect individual bottles.**
- **Ensure the protector sleeve or mat you use allows sufficient air flow and is odour free.**

WINE CARE

Having purchased our dual-zone Integrated Wine Cabinet, you can rest assured that your wines are well cared for. Your Integrated Wine Cabinet model has been designed to carefully consider both the maturation and ideal drinking temperature of all wine varieties. Our Wine Modes have been created to offer guidance for the perfect storage conditions for your wine, whilst allowing you adjustability to suit your personal needs.

Temperature

Temperature control is critical for the maturation of wines, as significant daily or weekly temperature fluctuations can denature wines. If storage temperatures are excessively high this can reduce the wines aromatic potential and can speed up maturation. This can cause some wines to take on a 'spoiled fruit' flavouring. If storage temperatures are excessively low, this can have the opposite effect and stunt a wine's natural maturation process. This can prevent a wine's flavours from developing to their full potential.

Humidity

Optimum humidity levels are also important for the storage of cork enclosed wines, especially for long term storage. Dry environments can lead to dried out corks encouraging wine evaporation as well as oxygen permeation leading to oxidised wine. As for extremely humid conditions, there is potential for mould growth on bottles and labels.

UV-Tempered Glass Door

Light is known to be damaging to wines, particularly UV light. Light can react with wine, creating hydrogen sulphide compounds affecting the tannins and colour. Your Integrated Wine Cabinet has been designed to eliminate this threat by incorporating a double UV-tempered glass door, dark interiors and dimmed LED lighting.

Vibration

Your Integrated Wine Cabinet model has been designed to have minimal vibrations, important for optimal wine care.

Ventilation

Wine should be stored in an odour-free environment. Your Integrated Wine Cabinet model comes with an activated carbon air filter to assist with removing taint and odour inside each compartment.

Helpful tips:

- Follow our pre-set Wine Modes as a guideline for optimal storage and the perfect drinking temperature.
- For entertaining, choose from one of our four Light Modes. Light Modes will default to Low after a certain duration to ensure the best wine care.
- If storing wine for long durations we recommend turning the Light Mode to Off.
- Store bottles lying flat on their sides to keep the liquid up against the cork which should keep the corks from drying out.
- Allow red wine to breathe. We suggest opening the bottle at least 1 hour before serving. Alternatively, decant red wine into a decanter.

REPLACING CARBON FILTER

Activated carbon filters

Air quality is critical for preserving wine. Your product is fitted with two activated carbon filters that help remove stale, unwanted odours and replenishes with fresh air. The filters are located internally at the bottom rear of each compartment.

We recommend replacing the activated carbon filter every 6 months. A replacement indicator icon on the control panel illuminates when the carbon filters need to be replaced.

To reset the filter indicator:

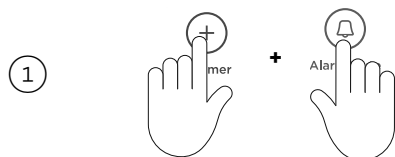

Press **+** and **!** together for four seconds.

The  on the control panel will turn off when reset.

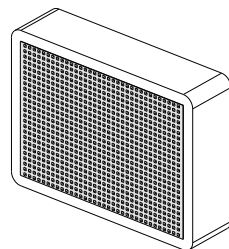

Carbon filter

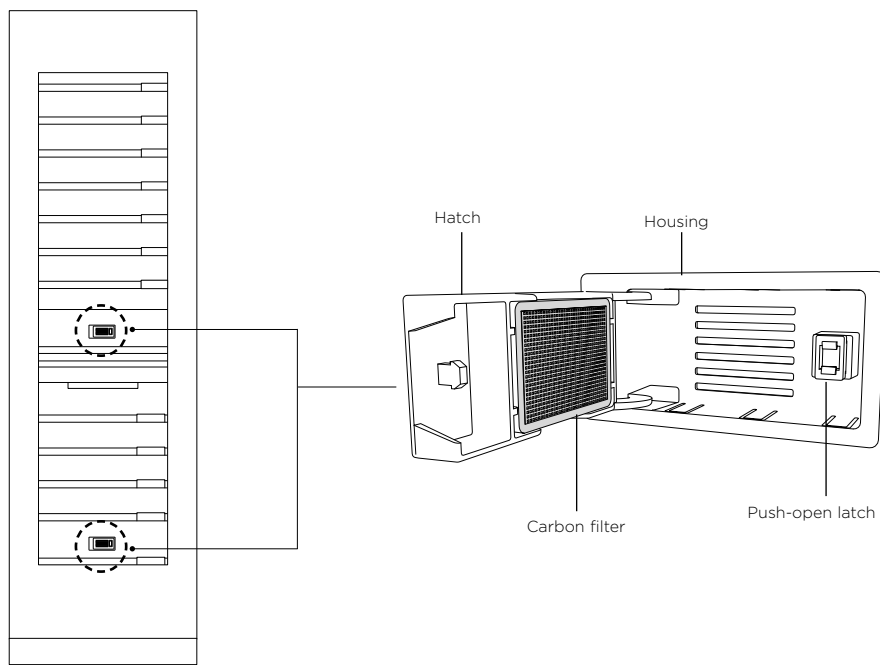

Replacement filters can be purchased online from fisherpaykel.com or by calling Fisher & Paykel Customer Care. Refer to Wine column installation guide for instructions on replacing the filters.

CLEANING CARE – EXTERIOR

Glass door

Use only mild liquid detergent dissolved in warm water and a soft cloth. Rinse with clean water and dry with a clean, lint-free cloth.

Stainless steel door panel

Use only mild liquid detergent dissolved in warm water and a soft cloth. Rinse with clean water and dry with a clean, lint-free cloth.

Toe kick grilles and filter

Your Integrated Wine Cabinet is fitted with a toe kick grille to protect the internal working components. We recommend cleaning the grille.

- The condenser coils of your Integrated Wine Cabinet require periodic cleaning by a Fisher & Paykel trained service technician.
- To maximize operating efficiency, keep ventilation openings clear of obstructions by regularly vacuuming the flooring in front of your appliance.
- More frequent cleaning may be necessary for dusty homes or those with pets shedding hair.

Other exterior surfaces

- We recommend to clean the magnetic door gasket every three months with a brush (eg old toothbrush) and liquid dishwashing agent dissolved in warm water.

IMPORTANT!

- **Many commercially available cleaning products contain solvents which may attack plastic components of your Integrated Wine Cabinet and cause them to crack.**
- **Avoid using anti-bacterial cleaning products on the interior or exterior of the Wine Cabinet, as they may cause rusting of metal components and cracking of plastic components.**

IMPORTANT!

Remove all wooden racks prior to cleaning.

- Do not use harsh chemicals, abrasives, ammonia, chlorine, bleach, concentrated detergents, solvents or abrasive scouring pads on any part of your appliance. Some of these chemicals may damage your appliance.

- Wipe interior surfaces with a mild liquid detergent dissolved in warm water and a soft cloth. Rinse with clean water and dry with a clean, lint-free cloth.

Wooden racks

Do not use water or cleaners for general (day-to-day) cleaning as they will damage the wood. Wine spills should be immediately wiped up to avoid rack staining. If a wine stain has appeared, it may be spot cleaned using mild liquid detergent dissolved in warm water and a soft cloth. Only just dampen the cloth and dab the stain to keep the wood as dry as possible. Follow up using a damp (water only), soft cloth and then dry thoroughly with a clean, dry cloth. If racks are heavily stained, the color may darken over time.

Replacement racks can be purchased through Fisher & Paykel Customer Care Center, or online at finsherpaykel.com (this service is available to selected markets only)

Removing the racks

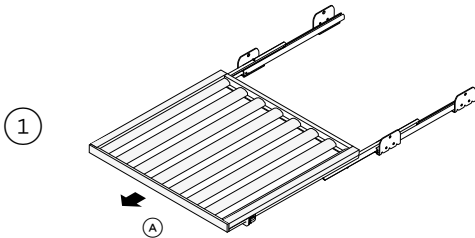

Remove the wine bottles from the racks. Extend the rack outward from the slides. **(A)**

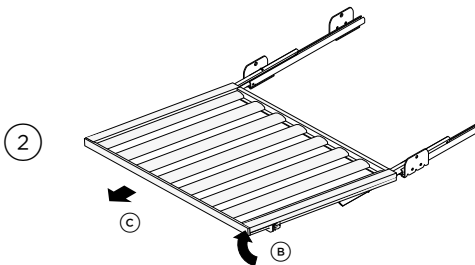

Lift the front end of the rack. **(B)**
Pull the rack towards you to remove. **(C)**

CLEANING CARE - INTERIOR

Repositioning the racks

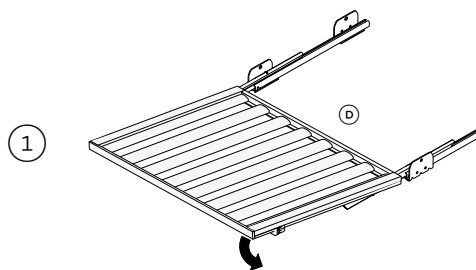

Align the back edge of the rack onto the desired support slides. **(D)**

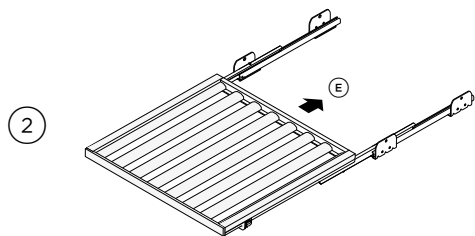

Push the rack into the wine cabinet all the way to the back of support slides until it locks in place. **(E)**

Ensure the rack is secure before use.

USER WARNINGS AND SOUNDS

Faults

- In the unlikely event a fault occurs, 4 rapid beeps will be heard and the fault will be displayed on the control panel.
 - Record the fault code displayed on the control panel and contact a Fisher & Paykel trained and supported service technician in order to repair the fault. You can do this by going online to fisherpaykel.com or by contacting our Customer Care Center.

Normal appliance sounds

This wine column has been designed to have excellent energy ratings and cooling performance. As a result, it can produce sounds somewhat different to your old appliance.



Normal operational sounds include:

- Low frequency ticking sound. This is the valve that controls cooling to each compartment. This noise will only last for a few seconds at a time.
- Fan air flow sound. Integrated columns has fans which change speed depending on demand. During cooling periods, such as after frequent door openings, fans circulate the cold air in the appliance producing some air flow sound. This is quite normal.
- Cracking or popping sounds. This may occur when the automatic defrost function is operating.
- Running water sound. This is the liquid refrigerant in the system and can be heard as a boiling or gurgling noise.
- Humming sounds. This is the compressor running and is quite normal.
- Other sounds may be heard for the following reasons:
 - Floor uneven or weak.

TROUBLESHOOTING

If there is a problem with your appliance, please check the following points before contacting your local Fisher & Paykel trained and supported service technician or the Customer Care Center.

Product parts and accessories can be purchased through the Fisher & Paykel Customer Care Center, or online at fisherpaykel.com (this service is available to selected markets only).

PROBLEM	POSSIBLE CAUSES	WHAT TO DO
Appliance does not operate	No electricity at power outlet.	Check that the plug is correctly connected and power switched on.
		Check another appliance at the same outlet.
		Check house fuse.
Light not working	Light not functioning.	The lighting cannot be serviced by the user. Contact your Fisher & Paykel dealer or trained and supported service technician.
	Appliance not working.	Check appliance is turned on at the wall or at the isolating switch.
Light and display not working	Product in Sabbath mode.	Press  ,  and  together for 4 seconds.
Storage compartments too warm	Temperature setting not correct.	See 'ActiveSmart™ special features' section of this User guide.
	Frequent door openings.	Minimize door openings to allow temperature to stabilize.
	Large amount of wine has been recently added.	Keep recommended bottle capacity.
Unfamiliar noises	Cabinet not stable or level.	See Installation guide supplied with this appliance.

TROUBLESHOOTING

PROBLEM	POSSIBLE CAUSES	WHAT TO DO
When the appliance door is opened 4 rapid beeps sound and a code is displayed on the control panel		Record the code on the control panel and contact Customer Care Center.
Exterior of cabinet is warm	Note: This is normal.	
Condensation on outside of appliance	Not unusual during periods of high humidity.	Wipe dry.
Condensation inside compartment	Frequent or long door openings.	Minimize door openings.
	Door gasket leaking.	Check and clean door gasket seal.
	Not unusual during periods of high humidity.	Wipe dry.
	Door not closing tightly.	Arrange items in the compartment so door can close tightly.
	Doors not aligned.	Call a service technician.
Door not closing	An obstruction is blocking door closing.	Move obstruction.
	Appliance not installed correctly.	Refer to your Installation guide supplied with this appliance to ensure your appliance has been installed correctly.

SERVICE & WARRANTY

For details of your manufacturer's warranty and contacts for servicing, refer to your separate service and warranty book provided with your appliance.

This product has been designed for use in a normal domestic (residential environment). This product is not designed for any commercial use. Any commercial use by the customer will affect this products manufacturer's warranty.

For spare parts, please contact Fisher & Paykel Customer Care. Spare parts are available for all Fisher & Paykel refrigerators for a minimum period of 10 years from the date of manufacture.

Complete and keep safe for reference:

Model _____

Serial No. _____

Purchase Date _____

Purchaser _____

Dealer _____

City _____

State _____

Zip _____

Country _____

FISHERPAYKEL.COM

© Fisher & Paykel Appliances 2020. All rights reserved.

The models shown in this guide may not be available in all markets
and are subject to change at any time.

The product specifications in this guide apply to the specific products and
models described at the date of issue. Under our policy of continuous product
improvement, these specifications may change at any time.

For current details about model and specification availability in your country,
please go to our website or contact your local Fisher & Paykel dealer.

863023D 10.20