

FISHER & PAYKEL

**AUTOMATIC BEAN TO CUP
COFFEE MACHINE**

EB24 model

USER GUIDE

US CA

CONTENTS

Appliance parts	2
Safety and warnings	4
First use	7
Menu settings	11
Making coffee	15
Making cappuccinos and milk-based coffees	19
Delivering hot water	22
Steam delivery	23
Customizing beverages	24
Memorizing your personal profile	25
Cleaning	26
Descale	32
Water softener filter	35
Displayed messages	37
Troubleshooting	42
Warranty and service	44

IMPORTANT!

SAVE THESE INSTRUCTIONS

The models shown in this user guide may not be available in all markets and are subject to change at any time. For current details about model and specification availability in your country, please go to our website fisherpaykel.com or contact your local Fisher & Paykel dealer.

Registration

Register your product with us so we can provide you with the best service possible.

To register your product visit our website: fisherpaykel.com

APPLIANCE PARTS

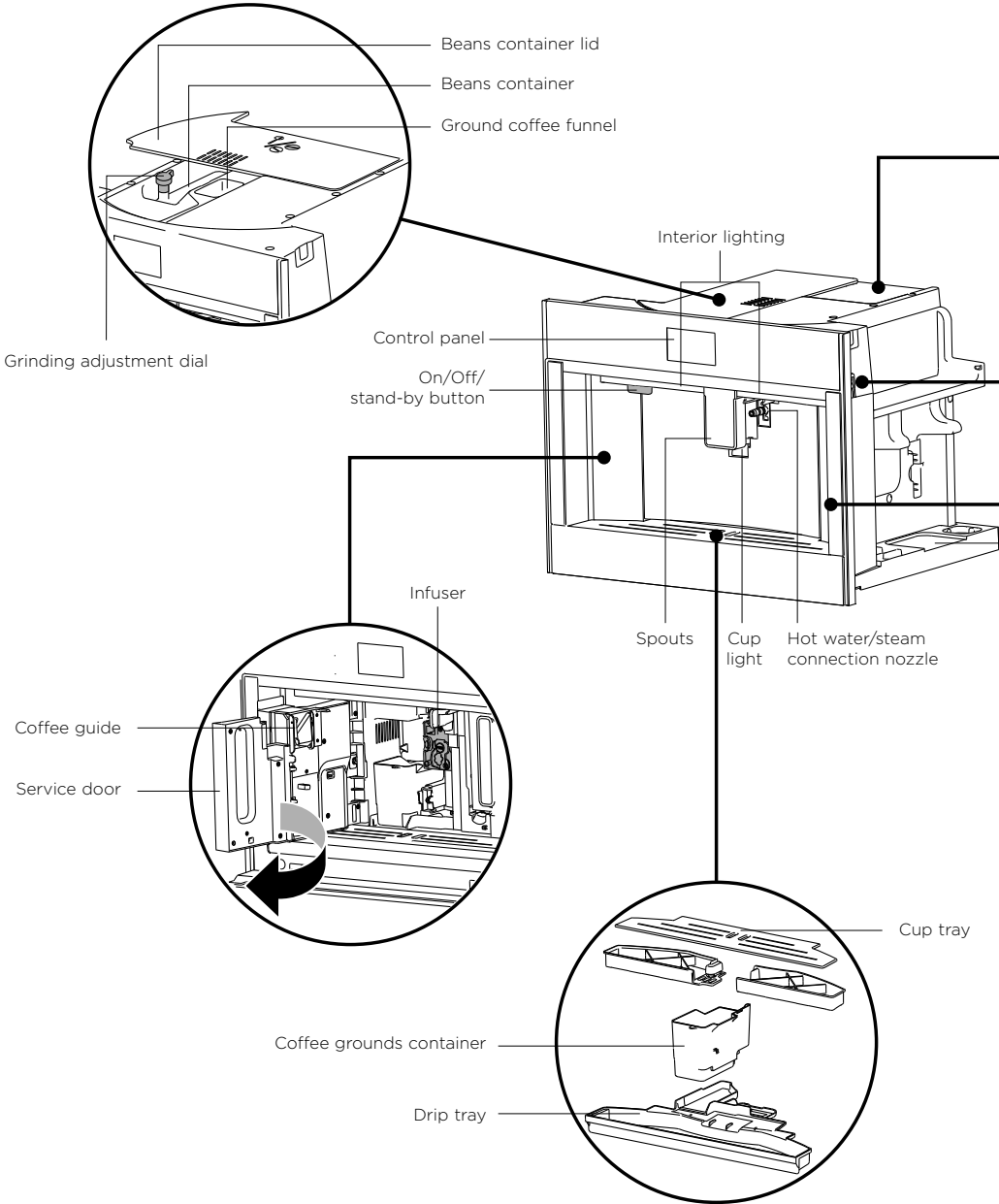

APPLIANCE PARTS

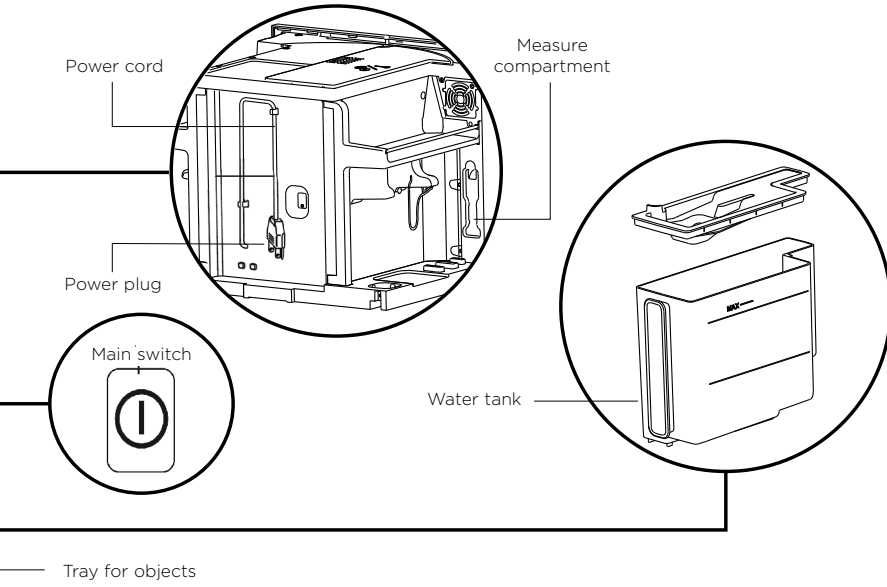

ACCESSORIES

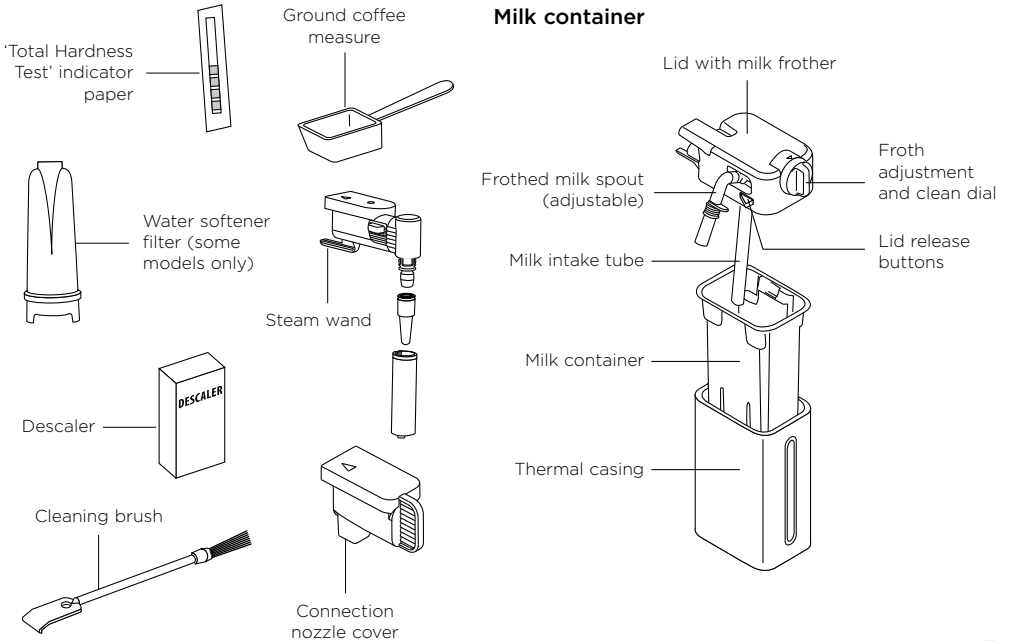

IMPORTANT SAFETY INSTRUCTIONS

Your safety is important to us. Keep the following instructions in mind when you are using your coffee maker.

Read all instructions before installation or use of the coffee system.

Please read these instructions carefully to prevent accidents and machine damage.

This appliance is for household use only, to prepare espresso, cappuccino and coffee. Do not use the appliance other than for its intended use. Any other use could be dangerous. The manufacturer cannot be held responsible for damage caused by improper use of the appliance.

⚠ WARNING!



Cut Hazard

Take care – some edges are sharp.

Failure to use caution could result in injury or cuts.

WARNING!

- **The coffee system must be maintained daily to prevent the growth of harmful bacteria and mold. Please read the Cleaning section of the booklet.**
- **Important! Do not look directly or with an optical instrument into the lighting.**
- **Danger of burns! Risk of burns when dispensing hot beverages, they are extremely hot.**
- **Persons which lack physical, sensory or mental abilities or experience with the machine should not use it without supervision or instruction by a responsible person.**
- **Close supervision is necessary when any appliance is used by or near children.**
- **Do not touch hot surfaces. Use handles or knobs.**
- **To avoid injuries allow the coffee system to cool before cleaning or putting on and taking off parts. Turn the machine off at the main switch when not in use and before cleaning.**
- **Only fill the water tank with cold, fresh tap water. Warm or hot water, or any other liquids may damage the machine.**
- **The water should be changed daily to prevent bacteria or mold growth.**
- **Do not use mineral water. Mineral water leads to heavy calcium buildup in the machine that can damage the unit.**
- **Do not fill anything but coffee beans into the beans container. Do not fill ground coffee in the beans container, it will damage the grinding unit.**
- **Sugar can damage the appliance! Caramelized or otherwise pre-treated coffee beans or other sugar containing beverages must not be put in the machine.**
- **Never place a cup with an alcohol-coffee mixture underneath the coffee dispenser. Plastic parts of the unit could catch fire!**
- **The hot water and steam dispensed could cause scalding. These functions must be used carefully. Never hold any parts of the body under the steam nozzle or the hot water dispenser. The machine must never be used to clean objects.**
- **Never use a steam cleaner to clean the appliance. Pressurized steam could damage electrical components and cause a short circuit.**
- **The appliances must be descaled regularly with the supplied descaling tablets. In areas with very hard water the machine may need to be descaled more often. The manufacturer cannot be held responsible for damages resulting from insufficient**

SAFETY AND WARNINGS

- descaling.
- **Only use the descaling tablets. Take care to use the correct mixture of water and descaler, otherwise it may cause damage.**
- **Never make coffee, hot water or steam when the appliance is extracted. Always make sure the appliance is inactive before extracting it. Failure to observe this precaution could lead to damage to the appliance! The only exception is adjusting the coffee mill which must be done with the machine out (see the section “Adjusting the coffee mill”).**
- **Do not place on or near a hot gas or electric burner, or in a heated oven.**
- **Do not operate any appliance with a damaged cord or plug or after the appliance malfunctions, or has been damaged in any manner. Return appliance to the nearest authorized service facility for examination, repair or adjustment.**
- **Do not use appliance for other than intended use.**
- **To reduce the risk of fire, do not mount unit over or near any portion of a heating or cooking appliance.**
- **To reduce the risk of electric shock, do not mount over a sink.**
- **Do not allow children and animals to stop or linger near the appliance when it is pulled out of the cabinet.**
- **Do not leave the machine pulled out of the cabinet when it is being used.**
- **Do not leave the machine pulled out of the cabinet when it is not needed.**
- **Install the machine according to the instructions in the handbook to guarantee there are no spills when it is pulled out from the cabinet.**

SAVE THESE INSTRUCTIONS

FIRST USE

Checking the appliance

After removing the packaging, make sure the product is complete. If the appliance is damaged, contact customer support.

Note: that coffee has been used to factory test the appliance, so it is possible that there may be traces of coffee in the mill.

- You should Customize water hardness as soon as possible following the instructions in section 'Setting water hardness'.

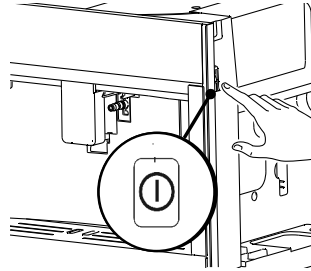
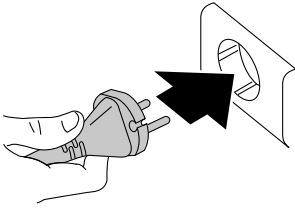

- Connect the appliance to the mains electricity supply.
- Make sure the main switch on the side of the appliance is pressed down.
- To select language press ◀ or ▶ until the flag corresponding to the required language appears on the display, then press the flag.

Display

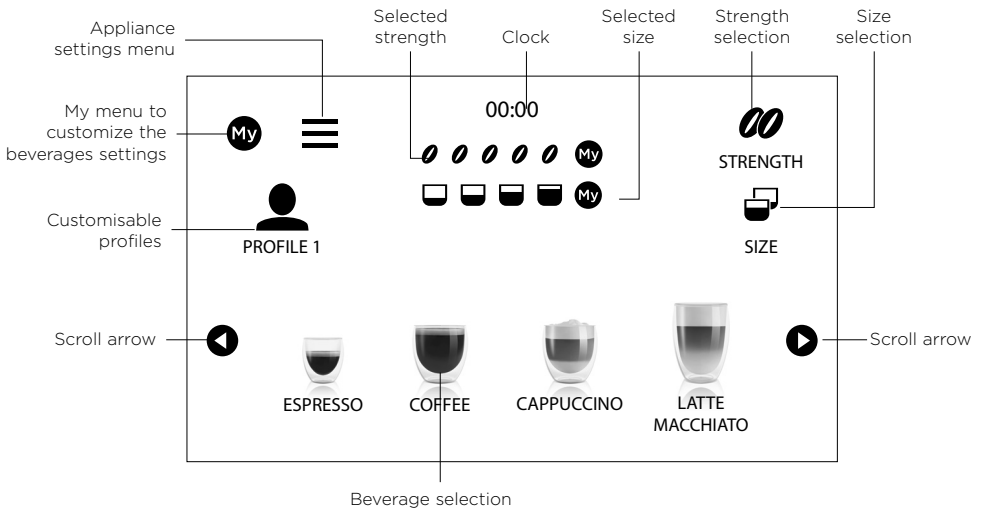

FIRST USE

Follow the instructions indicated on the appliance display:

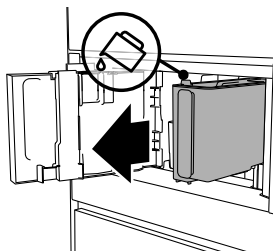

- ① FILL TANK WITH FRESH WATER: remove the water tank.

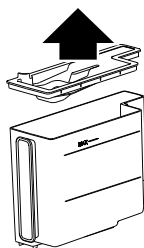

- ② Open the lid.

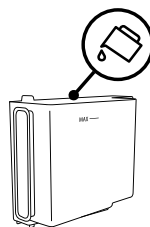

- ③ Fill with fresh water to the MAX line (marked on the inside of the tank).

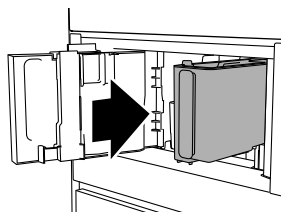

- ④ Close the lid and put the tank back in the appliance.

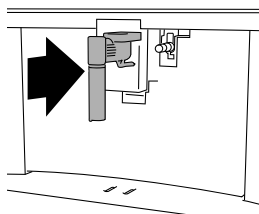

- ⑤ INSERT WATER SPOUT: Check that the steam wand is inserted on the connection nozzle.

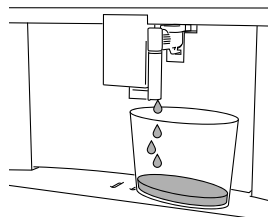

- ⑥ Place a container underneath the spouts.
⑦ WATER CIRCUIT EMPTY PRESS OK TO START FILLING PROCESS.
⑧ Press ✓ the appliance will deliver water from the spout and then turn off.

Note:

- When using the appliance for the first time, you will need to make four to five coffees, before the appliance starts to deliver a consistent level of beverage quality.
- When using the appliance for the first time, the water circuit is empty and the appliance could be noisy. This level of noise will reduce as the circuit fills.
- When making the first four to five coffees it is normal to hear the sound of boiling water. Following this, the noise will reduce.
- To improve the performance of your appliance, we recommend installing a water softener filter. If your model is not provided with a filter, you can request one from Customer Care.

Turning the appliance on

IMPORTANT!

During rinsing, a little hot water comes out of the coffee spouts and is collected in the drip tray underneath. During this cycle, keep hands clear of the spout to avoid contact with the water.

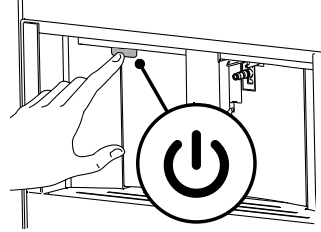
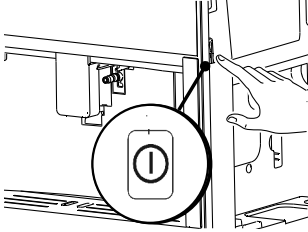

Note:

- Before turning the appliance on, make sure the main switch is pressed.
- Each time the appliance is turned on, it performs an automatic preheat and rinse cycle which cannot be interrupted.
- The appliance is ready for use only after completion of this cycle.

- ① To turn the appliance on, press . The message HEATING UP UNDERWAY PLEASE WAIT will appear on the display.
- ② When heating is complete, the message changes to: RINSING UNDERWAY, HOT WATER FROM SPOUTS. As well as heating the boiler, this also heats the internal circuits by circulating hot water.
- ③ The appliance is ready to use when the home screen appears on the display.

Turning the appliance off

Whenever the coffee maker is turned off after being used, it performs an automatic rinse cycle.

IMPORTANT!

- During rinsing, a little hot water flows from the coffee spouts. Keep hands clear of the spout to avoid contact with the water.
- Never press the main switch while the appliance is on or in stand-by mode.

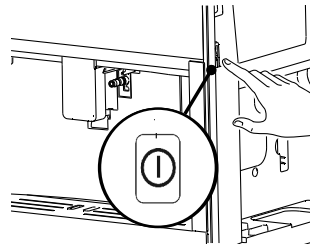
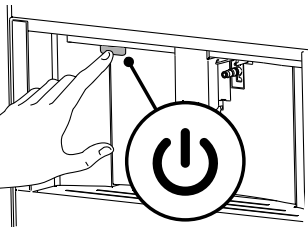

- ① To turn the appliance off, press .
- ② The message TURNING OFF, PLEASE WAIT will appear on the display. The appliance will perform a rinse cycle and then go into stand-by mode.

- ③ Press the main switch at the side of the appliance.
- ④ To ensure that cleaning message prompts appear on the display as scheduled, we recommend leaving the coffee maker in stand-by mode. If you will not be using the coffee maker for an extended period, turn the appliance off by pressing the main switch.

FIRST USE

Measuring and setting water hardness

How frequently the appliance alerts you that a descale is required, is determined by the level of water hardness. The appliance has a default water hardness setting of 4. However, to ensure the continued high performance of your coffee maker, it is important to measure the water hardness before the first use.

Measuring water hardness

- ① Remove the 'total hardness test' indicator paper from its pack.
- ② Immerse the paper completely in a glass of water for one second.
- ③ Remove the paper and shake lightly. After about a minute, a number of red squares form, which indicates the hardness of the water. Use this result to set the level of water hardness on the coffee maker. Each square corresponds to one level.

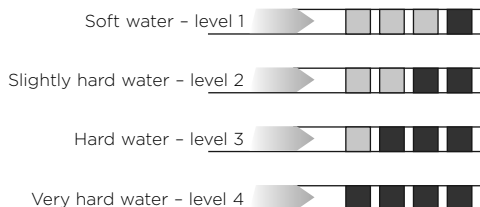

Setting water hardness

- ① Press **≡**.
- ② Press **◀** or **▶** until WATER HARDNESS appears on the display.
- ③ To change the level selected, press WATER HARDNESS until the required level of water hardness is displayed. (Level 1 = soft water; Level 4 = very hard water).
- ④ Press **BACK**.
The coffee maker is now programmed with the new water hardness setting.

MENU SETTINGS





Rinsing

Use this function to deliver hot water from the coffee spouts and steam wand, to clean and heat the appliance's internal circuit. Place a container under the coffee and hot water spouts.

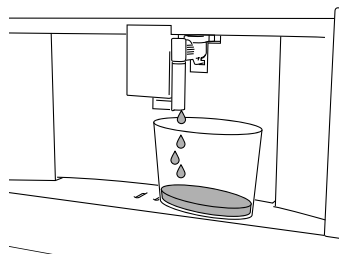
IMPORTANT!

Do not leave the appliance unattended while hot water is being delivered.



- ① Press .
- ② Press  or  until RINSING appears on the display.
- ③ Press  to start rinsing.







- ① After a few seconds, hot water is delivered first from the coffee spouts, then from the steam wand (if inserted). RINSING UNDERWAY, HOT WATER FROM SPOUTS appears on the display, along with a progress bar which fills gradually to indicate the stage of completion.
- ② The rinsing cycle will finish automatically. If you would like to cancel this function press CANCEL.

Note:

- If the appliance is not used for more than four days, when switched on again, we recommend performing three rinses before use.
- After cleaning, it is normal for the grounds container to contain water.

Drinks settings

This allows you to view the current drinks settings for each profile. By using this function, you can reset drinks settings to the default value. To customize the drinks settings to your personal preference, see the 'customizing drinks' section.

- ① Check that the profile you want to change the drinks settings for is active. The current active profile is displayed on the home screen. Press .
- ② Press  or  until DRINKS SETTINGS appears on the display. To change the drink press NEXT.
- ③ Press . The values for the first drink appear on the display.
- ④ The settings for each drink are displayed on vertical bars. The default value is indicated by a circle symbol at the side of the bar, while the current value is highlighted by the solid part of the vertical bar.
- ⑤ To go back to the settings menu, press BACK. To scroll and display more drinks, press NEXT.
- ⑥ To reset the default values for the drink displayed, press  RESET.
- ⑦ Press  to confirm. Press BACK to go back.
- ⑧ DEFAULT VALUES SET will appear on the display. Press . The drink has been reset to the default value.







Note:

- To change the drink settings in another profile, go back to the home screen, select the required profile and repeat the steps.
- To reset all the drinks in a profile to the default values, see the 'Default Values' section.

MENU SETTINGS

Set time

To adjust the time on the display:







- 1 Press .
- 2 Press  or  until SET TIME appears on the display
- 3 Press . The time setting panel will appear on the display.
- 4 Set the current time by pressing  or .
- 5 To confirm, press  (to cancel, press BACK), then press BACK to go back to the home screen.

Auto-start

You can set the auto-start time in order to have the appliance ready at a certain time (eg in the morning) so that the appliance is ready to make coffee immediately.

Note: To enable this function, the time must already be set correctly.

To enable auto-start:



- 1 Press .
- 2 Press  or  until AUTO START appears on the display.
- 3 Select the function by pressing AUTO START. The time setting panel appears on the screen.
- 4 Press  or  to set the time of day you require the coffee maker to automatically turn on.
- 5 Press OFF or ON to disable or enable auto start.
- 6 To confirm, press  or to cancel and return to the settings menu press BACK. Press BACK again to return to the home screen.

Note: If the auto-start function is enabled, and the mains switched is turned off, this function will be reset.

Auto off (standby)

The auto-off function can be enabled so that the appliance turns off after a set amount of time.



To programme Auto off:

- 1 Press .
- 2 Press  or  until AUTO OFF appears on the display.
- 3 Press AUTO OFF until the required timeframe is displayed.
- 4 Press BACK to go back to the home screen. The function is enabled and the appliance will turn-off after the timeframe that has been selected.

Energy saving

Use this function to enable or disable energy saving. When enabled, the function reduces energy consumption.

To disable or enable 'Energy Saving':



- 1 Press .
- 2 Press  or  until ENERGY SAVING appears on the display.
- 3 Press OFF or ON to disable or enable energy saving.
- 4 Press BACK.

If enabled, the corresponding symbol appears on the display alongside the time to indicate that the function has been enabled.

MENU SETTINGS

Coffee temperature





To modify the temperature of the water used to make the coffee:

- 1 Press .
- 2 Press  or  until SET COFFEE TEMPERATURE appears on the display along with the current selected temperature of: low, medium, high or maximum.
- 3 Press SET COFFEE TEMPERATURE until the required temperature is displayed.

Note: A different temperature can be set for each profile (see section 'Memorising your personal profile').

Selecting the language



To change the language of the display:

- 1 Press .
- 2 Press  or  until SET LANGUAGE appears on the display.
- 3 Press SET LANGUAGE. Press  or  to display the flag corresponding to the required language. Confirm your selection by pressing the required flag.
- 4 Press BACK to go back to the home screen.

Beep

This enables or disables the beep emitted by the machine each time an icon is pressed or an accessory is inserted/removed.



To disable or enable beeping:

- 1 Press .
- 2 Press  or  until BEEP SOUND appears on the display.
- 3 Press OFF or ON to disable or enable the beeping.
- 4 Press BACK.

Cup light

This function enables or disables the cup lights. The lights come on each time coffee drinks or hot milk is delivered and during each rinse cycle. The lights turn off after a few seconds.





To disable or enable this function, proceed as follows:

- 1 Press .
- 2 Press  or  until LIGHTS appears on the display.
- 3 Press OFF or ON to disable or enable the cup lights.

Note: The interior lighting comes on when the appliance is turned on.

Emptying the circuit

We recommend emptying the water circuit if the appliance is to be left idle for a long period of time, or before taking it to customer support for a service or repair:

- 1 Press .
- 2 Press  or  until WATER CIRCUIT EMPTYING appears on the display.
- 3 Press .
- 4 EMPTY GROUNDS CONTAINER AND DRIP TRAY: extract and empty the grounds container and drip tray. Press NEXT.

MENU SETTINGS

- ⑤ INSERT GROUNDS CONTAINER AND DRIP TRAY: insert the drip tray complete with grounds container
- ⑥ PLACE 2L CONTAINER UNDER SPOUTS, PRESS OK TO START: position a container under the coffee spouts and hot water spout. Press ✓.
- ⑦ RINSING UNDERWAY, PLEASE WAIT: the appliance performs a rinse cycle from the coffee spouts. Do not leave the appliance unattended while hot water is being delivered.
- ⑧ EMPTY WATER TANK: extract the tank and empty it completely, then press.
- ⑨ (If the filter is installed) REMOVE WATER SOFTENER FILTER: remove the filter from the tank. Press NEXT.
- ⑩ INSERT WATER TANK, PRESS OK TO CONTINUE: insert the water tank and press ✓.
- ⑪ WATER CIRC. EMPTYING UNDERWAY: wait for the appliance to empty the circuit. As the water circuit empties, the appliance could become noisy. This is part of normal operation. Do not leave the appliance unattended while hot water is being delivered.
- ⑫ EMPTY DRIP TRAY: remove, empty and reposition the drip tray, then press NEXT.
- ⑬ EMPTYING COMPLETE: press ✓.



Note: When turned on again, the appliance asks for the circuit to be filled.

- ⑭ WATER CIRCUIT EMPTY PRESS OK TO START FILLING PROCESS. Place a container under the spouts.
- ⑮ Press ✓ the appliance will deliver water from the spout and then turn off.

Default values

This resets all menu settings and programmed quantities back to the default settings (with the exception of the language which remains as set).

To reset the default values:





- ① Press .
- ② Press  or  until DEFAULT VALUES appears on the display. Press ✓.
- ③ Press RESET ALL to reset all of the user profiles or alternatively select an individual profile.
- ④ RESET DEFAULT VALUES: press ✓ to confirm or BACK to cancel.
- ⑤ DEFAULT VALUES RESET: Press ✓ or BACK to go back to the home screen.

Statistics

This function displays statistics relating to the appliance, including:

- The number of drinks that have been prepared.
- Amount of water that has been delivered.
- Total descales performed.
- Container cleans performed.
- Number of water filters used.













To display the statistics, relating to the appliance:

- ① Press .
- ② Press  or  until STATISTICS appears on the display.
- ③ Press ✓ to view all the available statistics by pressing  or .
- ④ Press BACK to go back to the main screen.

MAKING COFFEE

Selecting the strength of coffee

























Select the required strength by pressing STRENGTH :

	STRENGTH
 	Very Light
 	Light
 	Medium
 	Strong
 	Extra Strong
 	Customized strength - if programmed
	Pre-ground coffee

After delivering the drink, the strength setting is reset to the  value.

Selecting the coffee size

Select the required size of coffee delivered by pressing SIZE  from the display.

	SIZE
    	Small
    	Medium
    	Large
    	Extra Large
    	Customized size - if programmed

After delivering the drink, the size setting is reset to the  value.

MAKING COFFEE

Using coffee beans

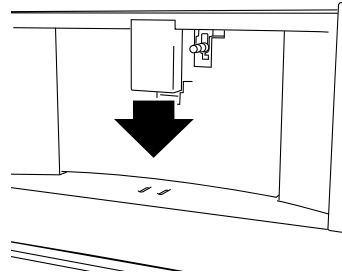
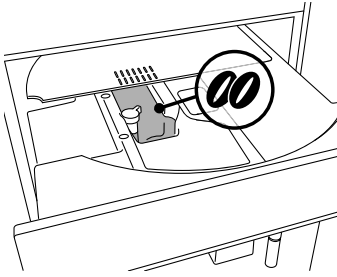

IMPORTANT!

Do not use green, caramelised or candied coffee beans as they could stick to the coffee mill and make it unusable.



- ① Fill the beans container with coffee beans.
- ② Place a cup under the coffee spouts.
- ③ Lower the spouts as near as possible to the cup. This makes for a creamier coffee.

Selecting a drink from the menu

- ① Press  or  until your chosen drink is displayed then select the drink:
 - Espresso
 - Double Espresso
 - Coffee
 - Long Black
 - Americano
- ② Preparation begins. An image of the selected drink appears on the display, together with a progress bar which gradually fills to indicate the stage of completion.

Note:

- You can prepare two cups of espresso coffee at the same time by pressing 2X  during preparation of one espresso (the image is displayed for a few seconds at the start of preparation).
- While the machine is making coffee, delivery can be cancelled at any moment by pressing CANCEL.
- As soon as delivery has ended, to increase the size of coffee in the cup, just press EXTRA. When desired size is reached, press CANCEL.

Note:

Various alarm messages could be displayed while using the appliance (FILL TANK, EMPTY GROUNDS CONTAINER, etc.). The actions to take are explained in section 'Displayed messages'.

- If the coffee is delivered a drop at a time, too weak and not creamy enough or too cold, read the tips in sections 'Adjusting the coffee mill' and 'Troubleshooting'.
- Preparation of each coffee can be customized (see sections 'Customizing the beverages' and 'Memorizing your personal profile').
- If 'Energy Saving' mode is active, you may have to wait a few seconds before the first coffee is delivered.

MAKING COFFEE

Making coffee using pre-ground coffee

IMPORTANT!

- **Never add pre-ground coffee when the machine is off or the grounds could spread through the inside of the appliance which may cause damage.**
- **Never use more than one level measure or it could dirty the inside of the coffee maker or block the funnel.**

Note: If you use pre-ground coffee, you can only make one cup of coffee at a time.

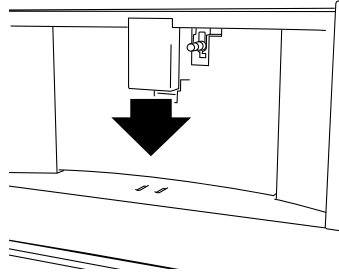
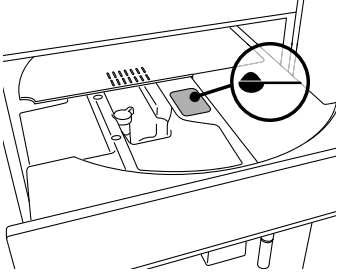

- ① Press **STRENGTH** **00** repeatedly until **☛** appears on the display.
- ② Open the lid.
- ③ Make sure the funnel is not blocked, then add one level measure of pre-ground coffee.
- ④ Place a cup under the coffee spouts.
- ⑤ Then select your required coffee (ESPRESSO, COFFEE, LONG) from the display.
- ⑥ Preparation begins. An image of the selected drink appears on the display, together with a progress bar which gradually fills to indicate the stage of completion.

Note:

- While the machine is making coffee, delivery can be cancelled at any moment by pressing **CANCEL**.
- As soon as delivery has ended, to increase the size of coffee in the cup, press **EXTRA**. When the preferred size is reached, press **CANCEL**.

MAKING COFFEE

Making long coffee

IMPORTANT!

Halfway through preparation, the message **ADD PRE-GROUND COFFEE, MAXIMUM ONE MEASURE** will be displayed. Add one level measure of pre-ground coffee and press ✓.

Tips for a hotter coffee

If you prefer a hotter coffee, you should:

- Perform a rinse cycle by selecting the RINSING function in the settings menu.
- Warm the cups with hot water using the hot water function (see section 'Delivering hot water').
- Increase the coffee temperature in the settings menu (see section 'Coffee temperature').

Adjusting the coffee mill

The coffee mill is set by default to prepare coffee correctly and should not require adjusting initially.

However, if after making the first few drinks you find that the coffee is either too weak, not creamy enough or delivery is too slow (a drop at a time), this can be corrected by adjusting the grinding adjustment dial.

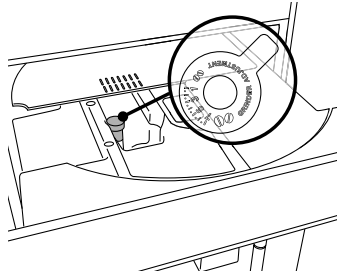

Note:

- The grinding adjustment dial must only be turned when the coffee mill is in operation during the initial phase of coffee preparation.
- If the coffee is delivered too slowly or not at all, turn one click clockwise towards 7.
- For fuller bodied creamier coffee, turn one click counter clockwise towards 1 (do not turn more than one click at a time otherwise the coffee could be delivered at a drop at a time).
- These adjustments will only be evident after at least two cups of coffee have been delivered. If this adjustment does not obtain the desired result, turn the dial another click.

MAKING CAPPUCCINOS AND MILK-BASED COFFEES

Note: To avoid milk with poor froth or large bubbles, always clean the milk container lid and hot water connection nozzle as described in sections 'Cleaning the milk container' and 'Cleaning the steam wand connection nozzle'.

Filling and attaching the milk container

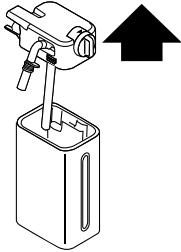

- ① Remove the lid.

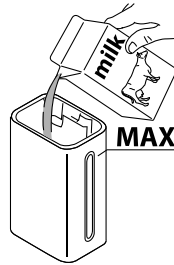

- ② Fill the milk container with a sufficient quantity of milk, not exceeding the MAX level marked on the container. Each mark on the side of the container corresponds to about 3.38 fl. oz. of milk.

Note:

- For a denser and more even froth, use refrigerated milk at about 41°F (5°C) temperature.
- If 'Energy Saving' mode is enabled, you may have to wait a few seconds before the drink is delivered.

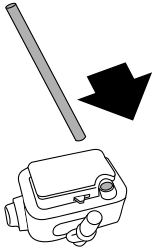

- ③ Make sure the milk intake tube is correctly inserted in the bottom of the milk container lid.

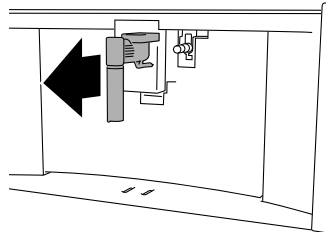

- ④ Place the lid back on the milk container.
⑤ Remove the steam wand.

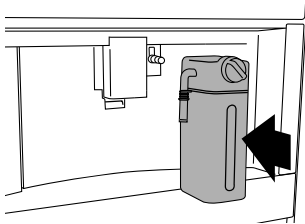

- ⑥ Attach the milk container to the connection nozzle and push as far as it will go. The appliance will beep (if the beep function is enabled).

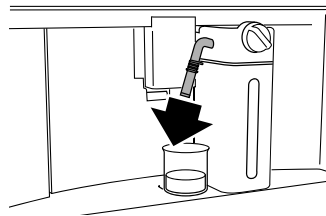



- ⑦ Place a cup under the coffee spouts and milk spout. The length of the milk spout is adjustable. To move it closer to the cup, pull it downwards.

MAKING CAPPUCCINOS AND MILK-BASED COFFEES

Adjusting the amount of froth

Turn the froth adjustment dial on the milk container lid to adjust the amount of froth delivered while making milk-based coffees. Follow the recommendations in the table below:

DIAL POSITION	FROTH	RECOMMENDED FOR
	None	Latte / Hot milk
	Minimum	Latte or Macchiato
	Maximum	Cappuccino

Making cappuccinos and milk-based coffees automatically

- ① Fill the milk container and attach it as described above.
- ② Select the required beverage from the display:
 - Cappuccino
 - Latte
 - Flat white
 - Latte macchiato
 - Espresso macchiato
 - Hot milk
- ③ A message on the display instructs you to turn the froth adjustment dial according to the froth required by the original recipe. Turn the dial on the milk container lid and confirm the selection by pressing ✓.
- ④ After a few seconds, preparation begins automatically and an image of the selected drink appears on the display, together with a progress bar which gradually fills to indicate the stage of completion.

General controls

- BACK: will cancel preparation completely and go back to the home screen.
- CANCEL: will cancel milk or coffee delivery and move on to the next delivery stage (if applicable) to complete the beverage.
- EXTRA will increase the size of coffee in the cup. This option is available at the end of the delivery.
- Preparation of each coffee can be customized (see sections 'Customizing the beverages' and 'Memorising your personal profile').
- Do not leave the milk container out of the refrigerator for long periods. 41°F (5°C) is the ideal milk temperature. The warmer the milk the poorer the quality of froth produced.

MAKING CAPPUCCINOS AND MILK-BASED COFFEES

Cleaning the milk container after use

IMPORTANT!

When cleaning the internal tubes of the milk container, a little hot water and steam may leak out of the frothed milk spout. Take care to avoid burns from hot splashes of water.

Each time you use a milk function, TURN DIAL TO <CLEAN> POSITION TO START CLEANING appears on the display and the milk frother lid must be cleaned:

- 1 Leave the milk container in the machine (you do not need to empty it).

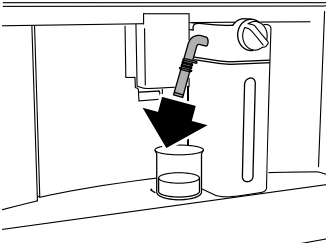

- 2 Place a cup or other container under the frothed milk spout.

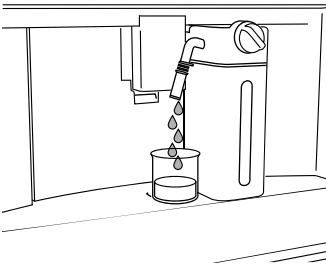

- 4 PLACE A RECIPIENT UNDER MILK SPOUT appears on the display together with a bar which gradually fills to indicate the stage of completion. Cleaning stops automatically.
- 6 Turn the dial back to one of the froth selections.

Note:

- When making a number of cappuccinos or milk based coffees, clean the milk container after you have prepared the last beverage only. To proceed with making the next beverages, when the CLEAN message is displayed, press BACK.
- If you do not clean the milk container,  appears on the display to remind you that it needs cleaning.
- The milk container can be kept in the refrigerator.
- In some cases, before cleaning you must wait for the appliance to heat up.

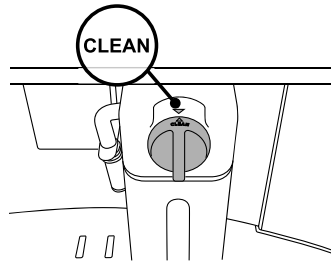

- 3 Turn the froth adjustment dial to CLEAN, CLEANING MILK CONTAINER UNDERWAY appears on display.

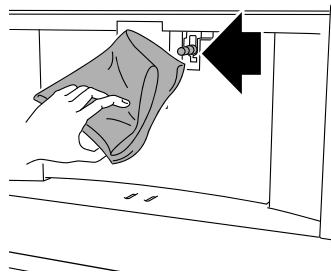

- 5 Remove the milk container and clean the steam connection nozzle with a sponge.

DELIVERING HOT WATER

IMPORTANT!

Do not leave the appliance unattended while hot water is being delivered.

- ① Make sure the steam wand is attached correctly to the hot water/steam connection nozzle.
- ② Place a container under the spout (as close as possible to avoid splashes).
- ③ Select HOT WATER The appliance delivers hot water and a progress bar appears on the display and fills gradually to indicate the stage of completion. The delivery of hot water stops automatically.
To cancel hot water delivery press CANCEL.

Note:

- If 'Energy Saving' mode is enabled, you may have to wait a few seconds before hot water is delivered.
- Preparation of hot water can be customized (see sections 'Customizing the beverages' and 'Memorizing your personal profile').

STEAM DELIVERY

IMPORTANT!

- **Do not leave the appliance unattended while steam is being delivered.**
 - **Always stop steam delivery before extracting the container filled with liquid to avoid burns from splashes.**
- ① Make sure the steam wand is attached correctly to the hot water/steam connection nozzle.
 - ② Fill a container with water to be heated or milk to be frothed and immerse the spout in the liquid.
 - ③ Select STEAM from the display. After a few seconds, steam to heat the liquid is delivered from the steam wand.
 - ④ When the desired temperature or level of froth is reached, end steam delivery by pressing CANCEL.

Note: If 'Energy saving' is enabled, you may have to wait a few seconds before steam is delivered.

Tips for using steam to froth milk

- When choosing the size of the container, bear in mind that the liquid doubles or triples in volume.
- For a richer denser froth, use skim or light milk at refrigerator temperature (about 41°F (5°C)).
- For a creamier froth, rotate the container with slow movements in an upward direction.
- To avoid milk with poor froth or large bubbles, always clean the spout as described in the following section.

Cleaning the steam wand and after use

Always clean the steam wand after use to avoid the build-up of milk residues and prevent it from clogging.

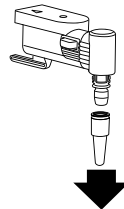
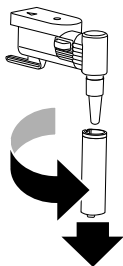
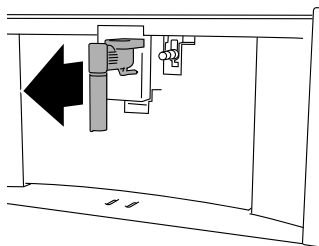





- ① Place a container under the steam wand and deliver a little water (see section 'Delivering hot water'). Stop delivery of hot water by pressing CANCEL.
 - ② Wait a few minutes for the spout to cool down, then extract.
 - ③ Hold the spout with one hand and with the other, turn the end of the spout and pull it downwards.
 - ④ Also remove the steam connection nozzle by pulling it downwards.
- ⑤ Check the hole in the connection nozzle is not blocked. If necessary, clean using a toothpick.
 - ⑥ Wash all parts of the spout thoroughly with a sponge and warm water.
 - ⑦ Insert the connection nozzle, then the end of the spout onto the steam wand by pushing it upwards and turning it clockwise until it is attached.

Drinks can be customized by altering the strength and size of coffee delivered.

IMPORTANT

As part of customizing the settings, coffee and milk will be delivered. So place a cup or container below the spouts.

- ① Make sure the profile you want to customize is active. The current active profile will be displayed on the home screen. To change the active profile, select the profile on display, then select from one of the six profile icons you would like to make active. This will allow you to modify the drink options for that profile. You can select MY beverages for each of the six profiles.
- ② From the home screen, press .
- ③ To access the customizing screen, choose the beverage you want to customize. The corresponding accessories must be inserted.
- ④ For beverages with coffee only CHOOSE COFFEE STRENGTH: Select the required strength by pressing  or  and press .
- ⑤ CUSTOMIZING COFFEE OR WATER QUANTITY, STOP TO SAVE: Delivery begins and on the display a vertical bar indicates the amount of coffee being delivered. The circle symbol alongside the bar indicates the current setting.
- ⑥ When the amount reaches the minimum quantity you can set, CANCEL is displayed.
- ⑦ When the desired quantity in the cup is reached, press CANCEL.
- ⑧ SAVE NEW SETTINGS?: Press YES or NO.

The appliance confirms if the values have been saved or not. Press .

Note:

- Cappuccino and milk-based coffees: the coffee strength is saved first, followed by the size of first milk, then coffee.
- HOT WATER: When the appliance delivers hot water. Press CANCEL to save the required size.
- Press BACK to exit. The values will not be saved.



Beverage size

BEVERAGE	STANDARD	PROGRAMMABLE
	fl oz (ml)	fl oz (ml)
Espresso	1.35 (40)	0.68 – 2.71 (20 – 80)
Long	5.41 (160)	3.89 – 8.45 (115 – 250)
Coffee	6.07 (180)	3.38 – 8.12 (100 – 240)
Double espresso	4.06 (120)	2.71 – 6.09 (80 – 180)
Hot water	8.45 (250)	0.68 – 14.20 (20 – 420)

MEMORIZING YOUR PERSONAL PROFILE

The appliance allows you to memorize six different profiles, each associated with a different icon.

The customized MY beverages strength and size values are saved in each profile (see section 'Customizing the beverages '). The order in which all the beverages are displayed is based on the frequency of selection.

To select or enter a profile, press on the profile currently in use , press  or  until the required profile is displayed, then press on the profile.

Note: GUEST profile: select this profile to deliver beverages with the default settings. The  function is not active.

CLEANING

Cleaning the appliance

The following parts of the appliance must be cleaned regularly (refer to page 2):

- The appliance's internal circuit.
- Coffee grounds container.
- Drip tray.
- Water tank.
- Coffee spouts.
- Pre-ground coffee funnel.
- Infuser, accessible after opening the infuser door.
- Milk container.
- Hot water/steam connection nozzle.
- Control panel.

IMPORTANT!

- **Do not use solvents, abrasive detergents or alcohol to clean the coffee maker. You need not use chemical products to clean the machine.**
- **None of the components of the appliance can be washed in a dishwasher with the exception of the milk container.**
- **Do not use metal objects to remove coffee deposits as they could scratch metal or plastic surfaces.**

Cleaning the machine's internal circuit

If the appliance is not used for more than three to four days, before using it again, we strongly recommend switching it on and:

- ① Performing two to three rinse cycles by selecting the 'Rinse' function (see 'Rinsing' section).
- ② Delivering hot water for a few seconds (see 'Delivering hot water' section).

Note: After cleaning, it is normal for the grounds container to contain water.

Cleaning the coffee grounds container

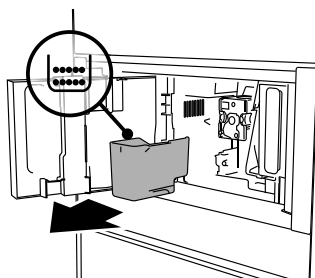

When EMPTY GROUNDS CONTAINER appears on the display, the grounds container must be emptied and cleaned. The appliance cannot be used to again until you have cleaned the grounds container. Even if the container is not full, the empty grounds container message is displayed 72 hours after the first coffee has been prepared. For the 72 hours to be calculated correctly, avoid turning the appliance off from the mains switch if it is not necessary.

CLEANING

To clean (with the appliance on):

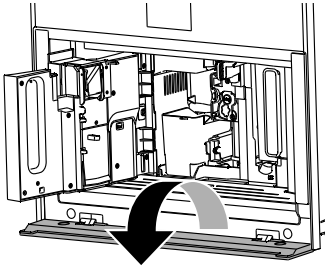

- ① Open the bottom door.

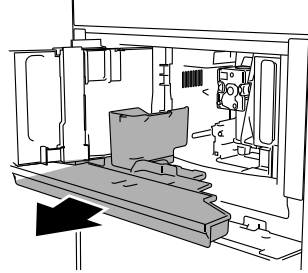

- ② Remove the drip tray, empty and clean.
- ③ Empty the grounds container and clean thoroughly to remove all residues left on the bottom. This can be done using the spatula or the brush provided.

IMPORTANT!

When removing the drip tray, the grounds container must be emptied, even if it contains few grounds. If this is not done, when you make the next coffees, the grounds container may fill up more than expected and clog the machine.

Cleaning the drip tray

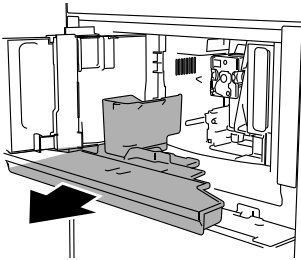

- ① Remove the drip tray and coffee grounds container.
- ② Empty the drip tray and grounds container and wash them.
- ③ Re-insert the drip tray and grounds container back into the appliance.

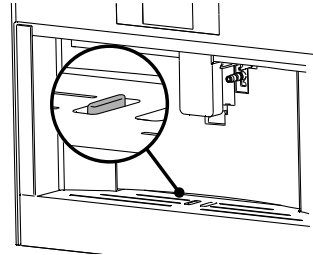

IMPORTANT!

- The drip tray is fitted with a level indicator (red) showing the level of water it contains.
- Before the indicator protrudes from the cup tray, the drip tray must be emptied and cleaned, otherwise the water may overflow the edge and damage the appliance, the surface it rests on or the surrounding area.

CLEANING

Cleaning the inside of the coffee maker

IMPORTANT!

Before cleaning internal parts, the appliance must be turned off (see section 'Turning the appliance off') and unplugged from the mains power supply. Never immerse the the appliance in water.

- ① Check regularly (about once a month) that the inside of the appliance (accessible after removing the drip tray) is not dirty.
- ② If necessary, remove coffee deposits with the brush supplied and a sponge. Remove all the residues with a vacuum cleaner.

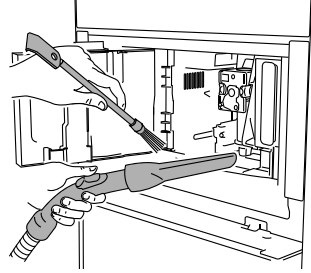

Cleaning the water tank

- ① Clean the water tank regularly (about once a month) and whenever you replace the water softener filter (if provided) with a damp cloth and little dishwashing liquid. Rinse thoroughly before filling the tank and putting it back in the appliance.
- ② Remove the filter (if present) and rinse with running water.
- ③ Replace the filter (if provided), fill the tank with fresh water and place the tank back into the appliance.
- ④ For models with water softener filter only: Deliver about 3 fl. oz. of hot water to reactivate the filter.

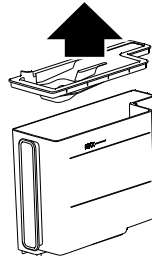

Cleaning the coffee spouts

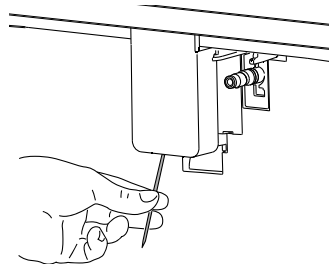
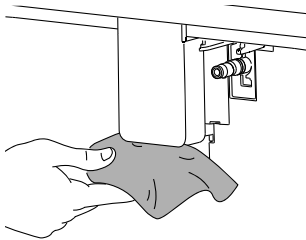

- ① Clean the coffee spouts regularly with a sponge or cloth.
- ② Check that the holes in the coffee spouts are not blocked. If necessary, remove coffee deposits with a toothpick.

Cleaning the pre-ground coffee funnel

Check regularly (about once a month) that the pre-ground coffee funnel is not blocked. If necessary, remove coffee deposits with the brush supplied.

CLEANING

Cleaning the infuser

The infuser must be cleaned at least once a month.

IMPORTANT!

The infuser must not be removed when the appliance is on. Do not use force to remove the infuser.

- ① Make sure the machine is correctly turned off (see Turning off).
- ② Open the service door.

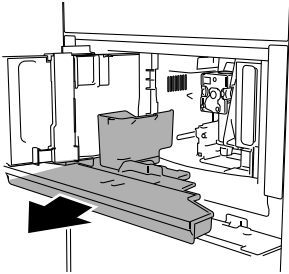

- ③ Remove the drip tray and waste coffee container.

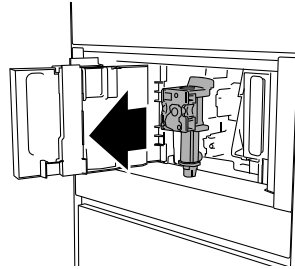

- ④ Press the two coloured release buttons inwards and at the same time pull the infuser outwards.

IMPORTANT!

Do not use dishwashing liquid to clean the infuser as it will remove the lubricant inside the piston.

- ⑤ Soak the infuser in water for about five minutes, then rinse.

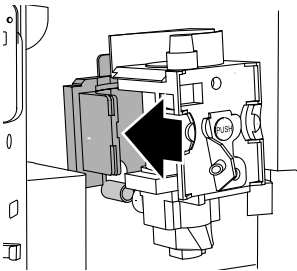

- ⑥ After cleaning, replace the infuser by sliding it onto the internal support and pin at the bottom, then push the PUSH symbol fully in until it clicks into place.

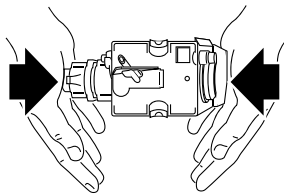

Note: If you encounter difficulty inserting the infuser, before inserting it you must adapt it to the right dimension by pressing it forcefully from the bottom and top as shown.

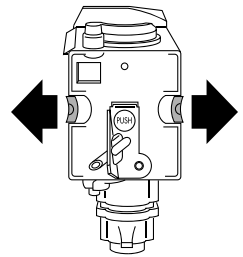

- ⑦ Once inserted, make sure the two coloured release buttons have snapped out.
- ⑧ Replace the drip tray and waste coffee container.
- ⑨ Close the service door.

CLEANING

Cleaning the milk container

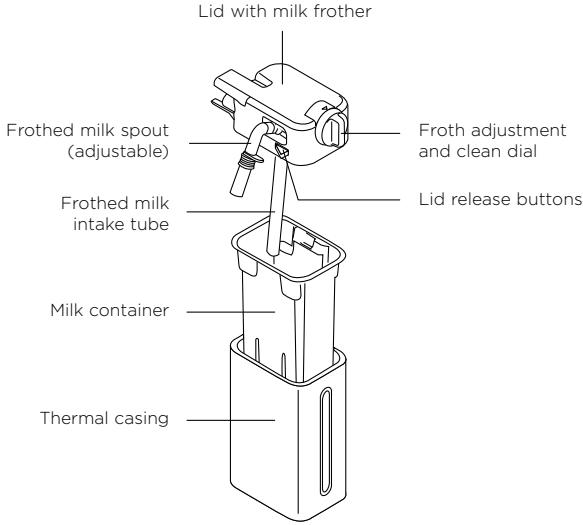

Each time the milk container needs to be re-filled, clean it as described below:

- ① Lift and remove the lid.
- ② Extract the milk container from the thermal casing, holding it by the two side grips.

IMPORTANT!

The thermal casing must not be filled with or immersed in water. Clean with a damp cloth only.

- ③ Remove the milk spout and intake tube.

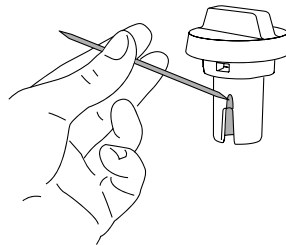
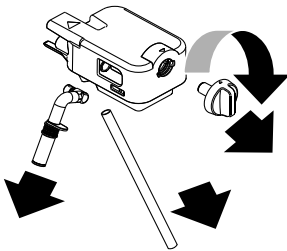

- ④ Turn the froth adjustment dial clockwise to the INSERT position and pull off.
- ⑤ Wash all the components of the frother thoroughly with hot water and dishwashing liquid. All components and the container are dishwasher safe. Make sure there are no milk residues on the hollow and groove under the dial. If necessary, scrape the groove with a toothpick.

CLEANING

- ⑥ Rinse inside the froth adjustment dial seat and the milk frother connector hole.
- ⑦ Check that the intake tube and spout are not clogged with milk residues.
- ⑧ Reposition the dial (lining up the arrow with the word INSERT). Reinsert the spout and milk intake tube.
- ⑨ Place the milk container in the thermal casing.
- ⑩ Place the lid back on the milk container.

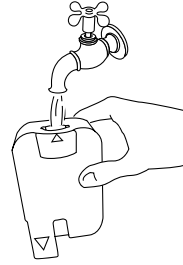

Cleaning the steam connection nozzle

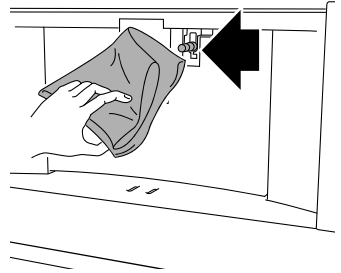

Each time you re-fill the milk container, clean the connection nozzle with a sponge to remove milk residues from the gaskets.



DESCALE





IMPORTANT!

- Read the instructions and the labelling on the descaler pack.
- Only use descaler Authorized by the manufacturer. Using unsuitable descaler and/or performing descaling incorrectly may result in faults not covered by the manufacturer's guarantee.

Descal the appliance when DESCALING NEEDED PRESS OK TO START (-45min)  appears on the display. To descale immediately, press  and follow the instructions from point four.

To descale the appliance later, press BACK. The  symbol appears on the display to remind you that the appliance needs descaling (the message appears each time you turn the appliance on).

To access the descaling menu:

- ① Press .
- ② Press  or  until  descale appears on the display.
- ③ Press  to start the descaling cycle then follow the instructions on the display.

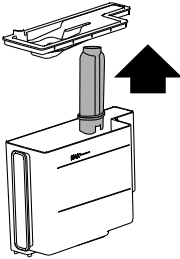

- ④ REMOVE WATER SOFTENER FILTER: remove the water tank, remove the water softener filter (if present) and empty the water tank. Press NEXT.

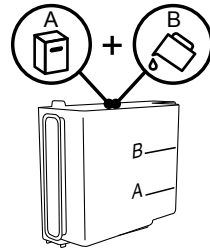

- ⑤ ADD DESCALER (LEVEL A) AND WATER (UP TO LEVEL B): Pour the descaler into the tank up to the level A marked inside the tank, then add water up to level B and put the water tank back. Press NEXT.

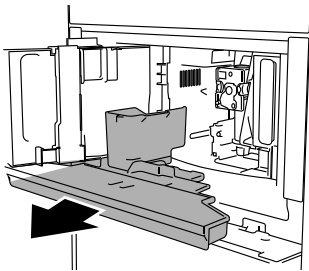

- ⑥ EMPTY GROUNDS CONTAINER AND DRIP TRAY: remove, empty and replace the drip tray and grounds container. Press NEXT.

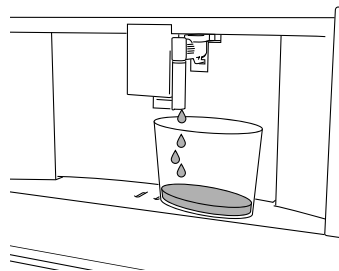

- ⑦ PLACE 2L CONTAINER UNDER SPOUTS PRESS  TO START DESCALING: Place an empty suitably sized container under the steam wand and coffee spouts.

DESCALE

IMPORTANT!

Hot water containing chemicals flows out of the spout. Take care to avoid contact with splashes of this solution.

- ⑧ Press ✓ to confirm that you have added the descaling solution. **DESCALING UNDERWAY, PLEASE WAIT** appears on the display. The descale programme starts and the descaler liquid comes out of the steam and coffee spouts. A series of rinses and pauses is performed automatically to remove all the scale residues inside the coffee maker.

After about 25 minutes, descaling stops:

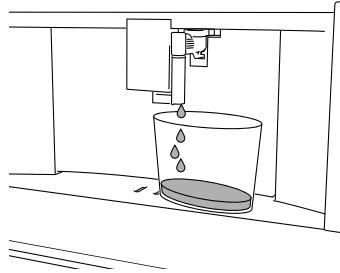
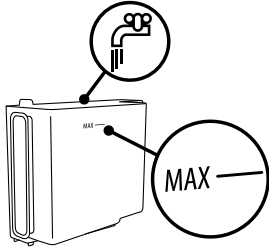

- ⑨ **RINSE AND FILL WATER TANK UP TO MAX LEVEL:** the appliance is now ready to rinse with fresh water. Empty the container used to collect the descaler solution. Remove the water tank, rinse under running water, fill with fresh water up to the MAX level and put back in the appliance.
- ⑩ **POSITION 2L CONTAINER OK TO START RINSING:** Place the container used to collect the descaler solution under the and steam spouts and press ✓.
- ⑪ Hot water is delivered first from the coffee spouts, then from the steam spout and **RINSING UNDERWAY, PLEASE WAIT** is displayed.
- ⑫ When the water in the tank has run out, empty the container used to collect the rinsing water.

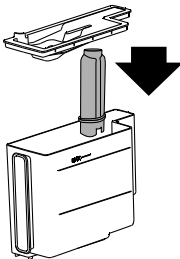

- ⑬ (If the filter is installed) **INSERT FILTER INTO ITS HOUSING.** Press **NEXT** and extract the water tank. Replace the water softener filter if removed previously.

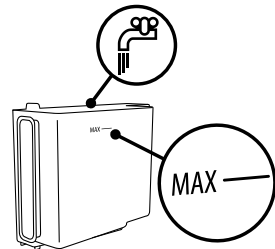

- ⑭ **RINSE AND FILL WATER TANK UP TO MAX LEVEL:** Fill the tank up to the MAX level with fresh water.

DESCALE

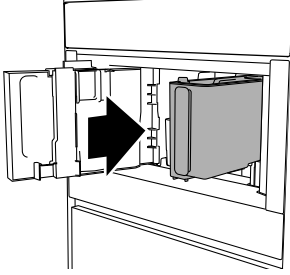

- ⑮ INSERT WATER TANK: Place the water tank back in the appliance.

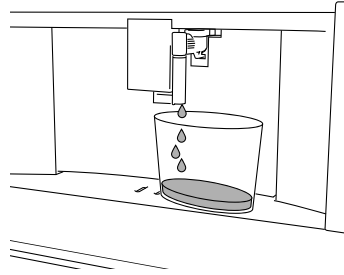

- ⑯ POSITION 2L CONTAINER OK TO START RINSING: Place the container used to collect the descaler solution empty under the hot water/steam spout and press ✓.
- ⑰ Hot water is delivered from the steam spout and RINSING UNDERWAY is displayed.

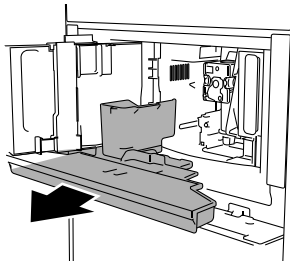

- ⑱ EMPTY DRIP TRAY: At the end of rinsing, remove, empty and replace the drip tray and grounds container. Press NEXT.
- ⑲ DESCALE COMPLETE: press ✓.
- ⑳ FILL TANK WITH FRESH WATER: empty the container used to collect the rinse water, remove the water tank and fill with fresh water up to the MAX level, then place the water tank back in the appliance.
- ㉑ Descaling is complete.





Note:

- If the descaling cycle is not completed correctly. For example if there was a power cut, we recommend repeating the cycle.
- After descaling, it is normal for the grounds container to contain water. If the water tank has not been filled to the MAX level, at the end of descaling, the appliance requests a third rinse to guarantee that the descaler solution has been completely eliminated from the machine's internal circuits. Before starting the rinse cycle, remember to empty the drip tray.
- The appliance may request descaling cycles at very short intervals. This is due to the appliance's advanced control system and is part of normal operation.

WATER SOFTENER FILTER

Certain models are fitted with a water softener filter. If this is not the case with your model, you are recommended to purchase one from an approved supplier. To use the filter correctly, follow the instructions below.

Installing the filter

- 1 Remove the filter from the packaging.
- 2 Press .
- 3 Press  or  until  WATER FILTER appears on the display.
- 4 Press .
- 5 TURN DATE INDICATOR TO DISPLAY NEXT 2 MONTHS: turn the date indicator disk until the next two months of the year are displayed. Press NEXT.

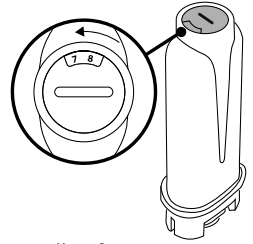

Note: The filter lasts about two months if the appliance is used normally. If the coffee maker is left unused with the filter installed, it will last a maximum of three weeks.

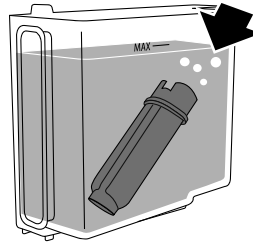

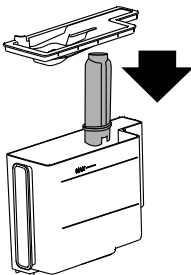

- 1 RUN WATER INTO FILTER HOLE UNTIL IT COMES OUT FROM OPENINGS: To activate the filter, run tap water through the hole in the filter as shown in the figure until water comes out of the openings at the side for more than a minute. Press NEXT.

- 2 Extract the tank from the appliance and fill with water.
- 3 IMMERSE FILTER IN THE WATER TANK LETTING AIR BUBBLES ESCAPE. Place the filter in the water tank immersing it completely for about ten seconds, allowing air bubbles to escape. Press NEXT.

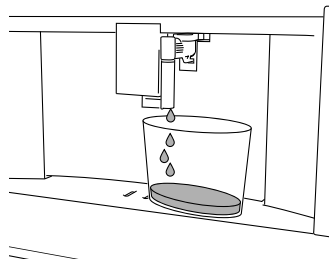

- 4 Insert the filter into the filter housing and press as far as it will go. Press NEXT.
- 5 INSERT WATER TANK: Close the tank with the lid, then place the tank back into the appliance.





- 6 PLACE 2L CONTAINER UNDER SPOUTS, press  TO FILL FILTER: Container has to hold at least 17 fl.oz. Delivery begins and stops automatically. The  symbol appears on the display alongside the time to indicate that the filter has been enabled.







You can now use the coffee maker.

WATER SOFTENER FILTER

Replacing the filter

Replace the filter when  REPLACE WATER SOFTENER FILTER, PRESS OK TO START appears on the display: to replace immediately, press  and follow the instructions from point four.











To replace the filter later, press BACK. The  symbol appears on the display to remind you that the filter needs replacing.

- ① Remove the tank and exhausted filter.
- ② Remove the new filter from the packaging.
- ③ Press .
- ④ Press  or  until  WATER FILTER appears on the display.
- ⑤ Press .
- ⑥  REPLACE FILTER appears on the display.
- ⑦ Press .
- ⑧ Follow the actions described in the previous section from point five. The filter is now active and you can use the coffee maker.

Note: After two months (see date indicator) or when the appliance has not been used for three weeks, you should replace the filter even if the 'replace filter' message has not yet been displayed.

Removing the filter

If you want to use the appliance without the filter, you must remove it and alter the settings in the appliance.

- ① Extract the tank and exhausted filter.
- ② Press .
- ③ Press  or  until  WATER FILTER appears on the display.
- ④ Press .
- ⑤  REMOVE FILTER appears on the display.
- ⑥ Press .
- ⑦  CONFIRM REMOVE FILTER: press  (or press BACK to go back to the settings menu).
- ⑧  FILTER REMOVED: the change has been saved. Press .

DISPLAYED MESSAGES

DISPLAYED MESSAGE

POSSIBLE CAUSE

WHAT TO DO

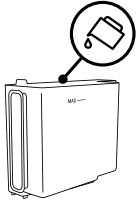

FILL TANK WITH FRESH WATER

Insufficient water in the tank.

Fill the tank with water and ensure that it is inserted correctly, pushing it as far as it will go until it clicks into place.

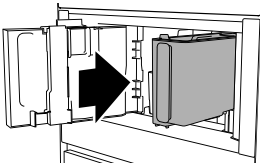

INSERT WATER TANK

The tank is not correctly in place.

Insert the tank correctly and press as far as it will go.

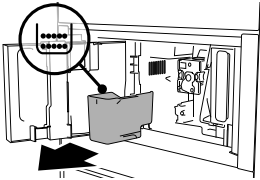

EMPTY GROUNDS CONTAINER

The grounds container is full.

Empty the grounds container and drip tray, clean and place it back in the appliance. Note: when removing the drip tray, the grounds container must be emptied, even if it contains few grounds. If this is not done, when you make the next drinks, the grounds container may fill up more than expected and clog the machine.

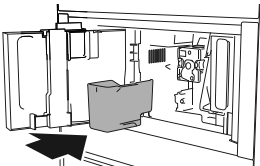

INSERT GROUNDS CONTAINER

After cleaning, the grounds container has not been re-inserted.

Remove the drip tray and insert the grounds container.

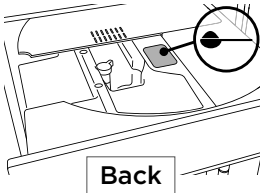

ADD PRE-GROUND COFFEE, COFFEE MAX. 1 MEASURE



The 'pre-ground coffee' function has been selected without placing any pre-ground coffee in the funnel.

Place pre-ground coffee in the funnel and repeat delivery.

The pre-ground coffee funnel is clogged.

Empty the funnel as described in section 'Cleaning the pre-ground coffee funnel.'

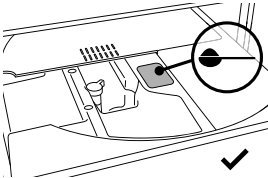
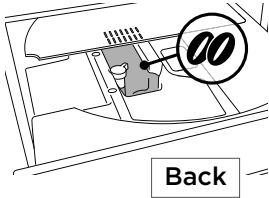
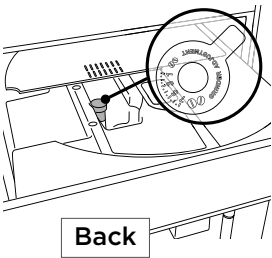
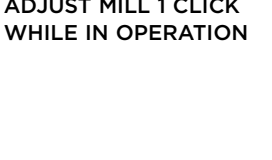

DISPLAYED MESSAGES

DISPLAYED MESSAGE	POSSIBLE CAUSE	WHAT TO DO
 <p>ADD COFFEE, COFFEE MAX. 1 MEASURE</p>	A long coffee with pre-ground coffee has been requested.	Place pre-ground coffee in the funnel and press ✓ to continue and complete delivery.
 <p>FILL BEANS CONTAINER</p>	The coffee beans have run out.	Fill the beans container.
 <p>GROUND TOO FINE. ADJUST MILL 1 CLICK WHILE IN OPERATION</p>	The grinding is too fine and the coffee is delivered too slowly or not at all.	Repeat coffee delivery and turn the grinding adjustment dial one click clockwise towards '7' while the coffee mill is in operation. If after making at least two coffees, delivery is still too slow, repeat the correction procedure, turning the grinding adjustment dial another click until delivery is correct (see section 'Adjusting the coffee mill'). If the problem persists, make sure the water tank is fully inserted.
 <p>SELECT A MILDER TASTE OR REDUCE PRE-GROUND COFFEE QUANTITY</p>	If you're using a water softener filter, an air bubble may have been released inside the circuit, obstructing delivery.	Deliver some water through the hot water spout until the flow becomes regular.
 <p>SELECT A MILDER TASTE OR REDUCE PRE-GROUND COFFEE QUANTITY</p>	Too much coffee has been used.	Select a milder strength by pressing STRENGTH  or reduce the quantity of pre-ground coffee (maximum 1 measure).

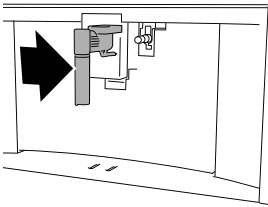
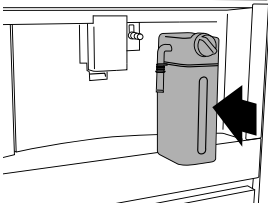
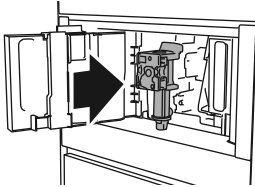
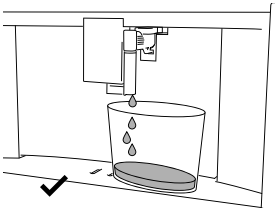



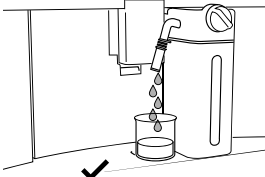
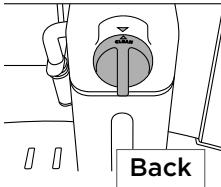
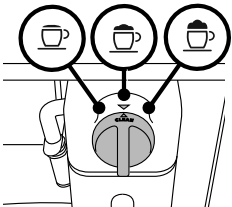



DISPLAYED MESSAGES

DISPLAYED MESSAGE	POSSIBLE CAUSE	WHAT TO DO
 INSERT WATER SPOUT	The hot water spout is not inserted or is not inserted correctly.	Insert the water spout as far as it will go.
 INSERT MILK CONTAINER	The milk container is not inserted correctly.	Insert the milk container as far as it will go.
 INSERT INFUSER ASSEMBLY	The infuser has not been replaced after cleaning.	Insert the infuser as described in section 'Cleaning the infuser'.
 WATER CIRCUIT EMPTY PRESS OK TO START FILLING PROCESS	The water circuit is empty.	Press ✓ to deliver water from the spout until it flows out normally. Delivery stops automatically. If the problem persists, make sure the water tank is fully inserted.

DISPLAYED MESSAGES

DISPLAYED MESSAGE	POSSIBLE CAUSE	WHAT TO DO
 <p>PRESS OK TO START CLEANING PROCESS OR TURN MILK FROTH ADJUSTMENT DIAL</p>	<p>The milk container has been inserted with the froth adjustment dial in the CLEAN position.</p>	<p>To proceed with the CLEAN function, press ✓ or turn the froth adjustment dial to one of the milk positions.</p>
 <p>TURN DIAL TO <CLEAN> POSITION TO START CLEANING</p>	<p>Milk has been delivered recently and the tubes inside the milk container must be cleaned.</p>	<p>Turn the froth adjustment dial to CLEAN.</p>
 <p>TURN THE MILK FROTH ADJUSTMENT DIAL TO MILK POSITION</p>	<p>The milk container has been inserted with the froth adjustment dial in the CLEAN position.</p>	<p>Turn the dial to the required froth position.</p>
 <p>Back</p> <p>DESCALING NEEDED PRESS OK TO START (-45min)</p>	<p>The machine must be descaled.</p>	<p>Press ✓ to start descaling or BACK to descale later. The descaling procedure described in section 'Descale' needs to be performed.</p>
 <p>Back</p> <p>REPLACE WATER FILTER PRESS OK TO START</p>	<p>The water softener filter is exhausted.</p>	<p>Press ✓ to replace or remove the filter, or BACK to carry out the procedure later. Follow the instructions in section 'Water softener filter'.</p>

DISPLAYED MESSAGES

DISPLAYED MESSAGE	POSSIBLE CAUSE	WHAT TO DO
 <p>GENERAL ALARM: REFER TO USER MANUAL</p>	<p>The inside of the appliance is very dirty.</p>	<p>Clean the inside of the appliance thoroughly, as described in section 'Cleaning'. If the message is still displayed after cleaning, contact Customer Care.</p>
	<p>The appliance needs descaling and/or the filter must be replaced.</p>	<p>The descaling procedure described in the 'Descale' section, needs to be performed and/or the filter needs replacing or removing as described in section 'Water softener filter'.</p>
	<p>The tubes inside the milk container must be cleaned.</p>	 <p>Turn the froth adjustment dial to CLEAN.</p>
	<p>The filter must be replaced.</p>	<p>Replace the filter or remove it as described in section 'Water softener filter'.</p>
	<p>The machine must be descaled.</p>	<p>The descaling procedure described in section 'Descale' needs to be performed.</p>
	<p>The auto-start function is enabled.</p>	<p>To disable the function, proceed as described in section 'Auto start'.</p>
	<p>Energy saving is enabled.</p>	<p>To disable energy saving, proceed as described in section 'Energy saving'.</p>

TROUBLESHOOTING

If the problem cannot be resolved as described, contact Customer Care.

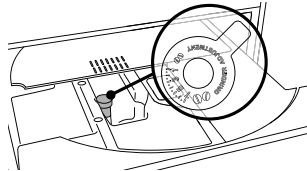
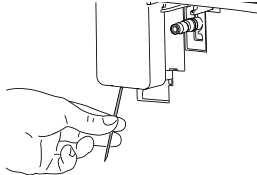
PROBLEM	POSSIBLE CAUSE	WHAT TO DO
The coffee is not hot	The cups were not preheated.	Warm the cups by rinsing them with hot water (Note: you can use the hot water function).
	The infuser has cooled down because two to three minutes have elapsed since the last coffee was made.	Before making the coffee, heat the infuser by rinsing using the rinse function (see section 'Rinsing').
	A low coffee temperature is set.	Set a hotter coffee temperature in the menu (section 'Coffee temperature').
The coffee is weak or not creamy enough	The coffee is ground too coarsely.	 <p>Turn the grinding adjustment dial one click counter clockwise towards '1' while the coffee mill is in operation. Continue one click at a time until you reach the desired coffee delivery. The effect is only visible after delivering two coffees (see section 'Adjusting the coffee mill'). If coffee is still not to your preference, try using a different brand of coffee.</p>
	The coffee is ground too finely.	Turn the grinding adjustment dial one click clockwise towards '7' while the coffee mill is in operation above figure. Continue one click at a time until you reach the desired coffee delivery. The effect is only visible after delivering two coffees (see section 'Adjusting the coffee mill').
The coffee is delivered too slowly or a drop at a time	The coffee is ground too finely.	Turn the grinding adjustment dial one click clockwise towards '7' while the coffee mill is in operation above figure. Continue one click at a time until you reach the desired coffee delivery. The effect is only visible after delivering two coffees (see section 'Adjusting the coffee mill').
Coffee does not come out of one or both of the spouts	The coffee spouts are blocked.	 <p>Clean the spouts with a toothpick.</p>
The appliance will not make coffee	The appliance has detected impurities in its internal circuits. 'Cleaning underway' is displayed.	Wait for the appliance to be ready for use again and reselect the required drink. Contact Customer Care if the problem persists.

TROUBLESHOOTING

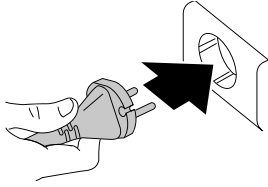
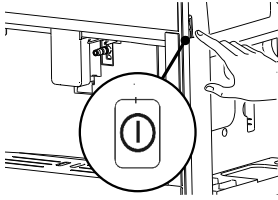
PROBLEM	POSSIBLE CAUSE	WHAT TO DO
<p>The appliance does not turn on</p>	<p>It is not plugged into the mains socket.</p>	<div style="text-align: center;">  </div> <p style="text-align: center;">Plug into the mains socket.</p>
	<p>The main switch is not turned on.</p>	<div style="text-align: center;">  </div> <p style="text-align: center;">Press the main switch.</p>
<p>The infuser cannot be extracted</p>	<p>The appliance has not been turned off correctly.</p>	<p>Turn the appliance off by pressing the AUTO OFF button (see section 'Turning the appliance off').</p>
<p>At the end of descaling, the appliance requests a third rinse</p>	<p>During the two rinse cycles, the water tank has not been filled to the MAX level.</p>	<p>Follow the instructions displayed by the appliance, but first empty the drip tray to avoid the water overflowing.</p>
<p>The milk does not come out of the milk spout</p>	<p>The lid of the milk container is dirty.</p>	<p>Clean the milk container lid as described in the 'Cleaning the milk container' section.</p>
<p>The milk contains large bubbles and squirts out of the milk spout or there is little froth</p>	<p>The milk is not cold enough or is not light or skimmed milk.</p>	<p>Use light or skimmed milk at refrigerator temperature (about 41°F (5°C)). If the result is not as you wished, try using a different brand of milk.</p>
	<p>The froth adjustment dial is incorrectly adjusted.</p>	<p>Adjust following the instructions in the 'Adjusting the amount of froth' section.</p>
	<p>The milk container lid or froth adjustment dial is dirty.</p>	<p>Clean the milk container lid and froth adjustment dial as described in the 'Cleaning the milk container' section.</p>
	<p>The hot water/steam connection nozzle is dirty.</p>	<p>Clean the connection nozzle as described in section 'Cleaning the hot water/steam connection nozzle'.</p>
<p>The machine emits noises or small puffs of steam while not in use</p>	<p>The machine is ready for use, or has recently been turned off, and condensation is dripping into the hot vaporiser.</p>	<p>This is part of normal operation. To limit this occurring, empty the drip tray.</p>

WARRANTY AND SERVICE

Before you call for service or assistance...

Check the things you can do yourself. Refer to the installation instructions and your user guide and check that:

- ① Your product is correctly installed.
- ② You are familiar with its normal operation.

If after checking these points you still need assistance or parts, please refer to the Service & Warranty book for warranty details and your nearest Authorized Service Centre, Customer Care, or contact us through our website fisherpaykel.com.

Complete and keep for safe reference:

Model _____
Serial No. _____
Purchase Date _____
Purchaser _____
Dealer _____
City _____
State _____
Zip _____
Country _____

FISHERPAYKEL.COM

© Fisher & Paykel Appliances 2020. All rights reserved.

The product specifications in this booklet apply to the specific products and models described at the date of issue. Under our policy of continuous product improvement, these specifications may change at any time. You should therefore check with your Dealer to ensure this booklet correctly describes the product currently available.

US CA

591473C 01.20