

FISHER & PAYKEL

CONVECTION SPEED OVEN

PROFESSIONAL

OM30NPX1 models

USER GUIDE

US CA

⚠ WARNING!

Precautions to avoid possible exposure to excessive microwave energy

- Do not attempt to operate this microwave with the door open. This can result in harmful exposure to microwave energy. It is important not to damage or tamper with the safety interlocks.
- Do not place any object between the microwave oven and the door or allow soil or cleaner residue to accumulate on sealing surfaces.
- Do not operate the microwave oven if it is damaged. It is particularly important that the microwave oven door close properly and that there is no damage to the: (1) door (bent), (2) hinges and latches (broken or loosened), (3) door seals and sealing surfaces.
- Do not repair or replace any part of the appliance unless specifically recommended in this guide. All other servicing should be done by a Fisher & Paykel trained and supported service technician.

CONTENTS

Safety and warnings	5
Before you begin	9
Control panel	10
Accessories	11
First use	12
Using the oven light	16
Using the timer	17
Cooking guide	18
Automatic cooking	21
Microwave cooking	23
Recipes	24
Event logs	27
Troubleshooting	28
Warranty and service	30

Registration

To register your product visit our website: fisherpaykel.com/register

⚠ WARNING!



Electric Shock Hazard

Failure to follow this advice may result in electric shock or death.

- Before carrying out any work on the electrical section of the appliance, it must be disconnected from the mains electricity supply.
- Connection to a good ground wiring system is absolutely essential and mandatory.
- Alterations to the domestic wiring system must only be made by a qualified electrician.
- Turn the oven off at the wall before replacing the oven lamp.

⚠ WARNING!



Cut Hazard

Failure to use caution could result in injury.

- Take care - some edges are sharp.

⚠ WARNING!



Fire Hazard

Failure to follow this advice may result in overheating, burning, and injury.

- Do not use adapters, reducers, or branching devices to connect this appliance to the mains power supply.

READ AND SAVE THIS GUIDE

WARNING!

To reduce the risk of fire, electrical shock, injury to persons or damage when using the appliance, follow the important safety instructions listed below. Read all the instructions before use. Use only for its intended purpose as described in these instructions.

Installation

- Ensure your appliance is properly installed and grounded by a qualified technician in accordance with the provided installation instructions.
- Install or locate this appliance only in accordance with the provided installation instructions.
- Do not install or operate the appliance if it is damaged or not working properly. If you receive a damaged product, contact your dealer or installer immediately.
- The appliance must not be installed behind a decorative door in order to avoid overheating.
- Do not mount this appliance over a sink.
- This oven is not approved or tested for marine use.
- Do not store this appliance outdoors. Do not use this near a swimming pool, near a sink or in similar locations
- Do not immerse cord or plug in water. Do not let cord hang over edge of table or counter. Keep cord away from heated surfaces.
- Do not cover or block any openings on the appliance.

Servicing

- User servicing: do not repair or replace any part of the appliance unless specifically recommended in this guide. All other servicing should be done by a Fisher & Paykel trained and supported service technician.
- If the door or door seals are damaged, the oven must not be operated until it has been repaired by a trained person.
- It is hazardous for anyone other than a trained person to carry out any service or repair operation which involves the removal of any cover which gives protection against exposure to microwave energy.
- If the microwave oven light fails, contact a Fisher & Paykel trained and supported service technician or Customer Care.

Fire hazard

- Do not overcook food. Carefully attend appliance when paper, plastic or other combustible materials are placed inside the microwave oven to facilitate cooking.
- Remove wire twist-ties from paper or plastic bags before placing in microwave.
- If materials inside the microwave oven should ignite, keep microwave oven door closed, turn microwave oven off and disconnect the power cord or shut off power at the fuse or circuit breaker panel.
- Do not use the cavity for storage purposes. Do not leave paper products, cooking utensils or food in the cavity when not in use.
- Utensils should be checked to ensure that they are suitable for use in microwave ovens.
- When heating food in plastic or paper containers, check the oven frequently due to the possibility of ignition.
- If smoke is observed, switch off or unplug the appliance and keep the door closed in order to stifle any flames.

SAFETY AND WARNINGS

- During and after use, do not touch, or let clothing or other flammable materials contact any interior area of the oven; allow sufficient time for cooling first.
- In case of fire, smother the flame or use a dry chemical or foam type extinguisher.
- Use only dry oven mitts or potholders. Moist or damp potholders on hot surfaces could result in burns from steam. Do not let potholders touch hot areas or heating elements. Do not use a towel or a bulky cloth for a potholder. It could catch fire.

Food safety

- Safe food handling: leave food in the oven for as short a time as possible before and after cooking. This is to avoid contamination by organisms which may cause food poisoning. Take particular care during warm weather.

General

- This product has been designed for use in a domestic (residential) environment. This product is not designed for any commercial use. Any commercial use by the customer will affect this product's manufacturer's warranty.
- Household appliances are not intended to be played with by children.
- Do not leave children alone. Children should not be left alone or unattended in the area where the appliance is in use. They should never be allowed to sit or stand on any part of the appliance.
- **HOT CONTENTS CAN CAUSE SEVERE BURNS. DO NOT ALLOW CHILDREN TO USE THE MICROWAVE.** Children of less than 8 years old must be kept away from the appliance unless continuously supervised. This appliance can be used by children aged from 8 years and above, and persons with reduced physical, sensory or mental capabilities or lack of experience and knowledge, if they have been given supervision or instruction concerning the use of the appliance in a safe way and they understand the hazards involved. Cleaning and user maintenance shall not be done by children without supervision.
- Do not place heavy objects on the oven door.
- Do not let aluminium foils and food probes touch the heating elements.
- Do not operate your appliance by means of an external timer or separate remote control system.
- Placement of oven shelves: always position shelves in the desired location while the oven is cool (before preheating). If a shelf must be removed while the oven is hot, do not let the oven mitts or potholder contact hot heating elements in the oven or the base of the oven.
- During use the appliance becomes hot. Care should be taken to avoid touching heating elements inside the oven.
- Do not heat unopened food containers. They can build up pressure that may cause the container to burst and result in injury.

Cleaning

- The oven must be cleaned periodically and all food residues must be removed.
- Failure to keep the oven clean could cause deterioration of the surfaces that could reduce the life of the appliance and cause dangerous conditions.
- Do not use oven cleaners, harsh/abrasive cleaning agents, waxes, or polishes. No commercial oven cleaner, oven liner, or protective coating of any kind should be used in or around any part of the oven. Do not use harsh/abrasive cleaners, scourers or sharp metal scrapers to clean the oven door glass since they scratch the surface, which may result in the glass shattering.
- Avoid using products containing chlorine, acids or abrasives, especially for cleaning painted parts. In addition, avoid using acid or alkaline substances.

SAFETY AND WARNINGS

- Do not spray water or use a steam cleaner to clean any part of the oven. Use only slightly damp cloths.

Microwave cooking

- Do not operate microwave functions while the oven is empty.
- Do not operate microwave functions without the turntable in place. The turntable must be unrestricted so it can turn.
- Eggs in their shells and whole hard-boiled eggs should not be heated in microwave ovens since they may explode, even after microwave heating has ended.
- The contents of feeding bottles and baby food jars are to be stirred or shaken and the temperature is to be checked before consumption, in order to avoid burns.
- Microwave heating of beverages can result in delayed eruptive boiling, therefore care has to be taken when handling the container.
- Liquids, such as water, coffee or tea are able to be overheated beyond the boiling point without appearing to be boiling. Visible bubbling or boiling when the container is removed from the microwave oven is not always present. THIS COULD RESULT IN VERY HOT LIQUIDS SUDDENLY BOILING OVER WHEN A SPOON OR OTHER UTENSIL IS INSERTED INTO THE LIQUID.
- Do not overheat liquid. To avoid delayed boiling when heating liquids, always put a spoon in the container. Beverages containing spoons should be placed in the centre of the glass turntable. Metal components must stay at least 2 cm from the walls of the oven and the inside of the door. Sparks could damage the inside of the glass door. Stir the liquid both before and halfway through heating it.
- Do not use straight-sided containers with narrow necks. Use a wide-mouthed container.
- After heating, allow the container to stand in the microwave oven for at least 20 seconds before removing the container.
- Use extreme care when inserting a spoon or other utensil into the container.

Unsuitable dishware

- The flat grill must be removed when using the microwave and combined modes. It can only be used with convection functions.
- Never turn on the microwave oven before you have put in the food. The only exception allowed is testing dishware.
- Only use plates and crockery that are microwave safe.
- Never heat food covered in tin foil.
- Use only bakeware approved for oven use. Follow the manufacturer's instructions.

Pacemakers

- Most pacemakers are shielded from interference from electronic products, including microwaves. However, patients with pacemakers may wish to consult their physicians if they have concerns.

Arcing

Arcing can occur during both speed cooking and microwave cooking. If you see arcing, press CANCEL/OFF and correct the problem. Arcing is the microwave term for sparks in the oven. Arcing is caused by:

- Metal or foil touching the side of the oven.
- Metal cookware or the wire oven rack used during either speedcook or microwave cooking.
- Metal such as twist-ties, poultry pins, or goldrimmed dishes in the oven.
- Recycled paper towels containing small metal pieces being used in the oven.

BEFORE YOU BEGIN

- Ensure the installer has completed the 'Final checklist' in the Installation instructions.
- Read this guide, taking special note of the 'Safety and warnings' section.
- Remove all internal and external packaging and dispose of it responsibly. Recycle items that you can.
- Condition the oven, using the instructions under 'First use'.

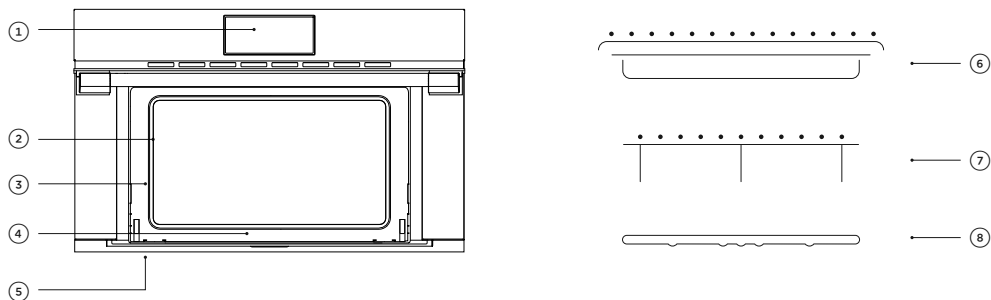

Oven features and accessories

- | | |
|------------------------|-----------------------------|
| ① Control panel | ⑤ Oven vent louvres |
| ② Oven light location | ⑥ Baking pan and wire shelf |
| ③ Oven seal | ⑦ Turntable wire stand |
| ④ Identification plate | ⑧ Glass turntable |

Not shown: oven door and handle.

CONTROL PANEL



Control panel features

- | | |
|--------------------|----------------|
| ① Display | ⑤ Power |
| ② Keypad | ⑥ Confirm |
| ③ Cancel | ⑦ Timer |
| ④ Navigation arrow | ⑧ Cavity light |

Using the touch controls

Your oven is operated using a touch keypad and display. To use the keypad to navigate between functions and settings, use the ball of your finger, not its tip. The controls respond to touch, so pressure is not needed.

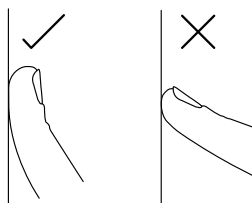

ACCESSORIES

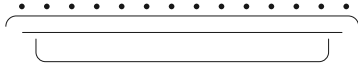

Wire shelf

To remove, pull towards you and then lift.
To insert, slide the shelf at a 45° angle until it locks. Then lower and push the shelf all the way to the end of the broil track.

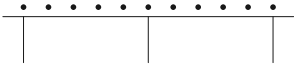

Turntable wire stand

Slide the broil rack into the oven at a 45° angle ensuring it locks into place. Gently lower and push into the notches in the oven cavity.



Glass turntable

Position the glass turntable into the oven cavity ensuring all three notches are secure.

FIRST USE

When using your oven for the first time, you will be prompted to:

- change the time
- change the clock format (12 hours or 24 hours)
- change the units for temperature and weight
- adjust the volume of audio feedback
- change the language of the display

These settings can be modified at any time in the settings menu.

①

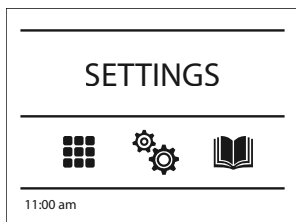

Locate the **SETTINGS** menu using the arrow keys. Press ✓ to confirm.

②

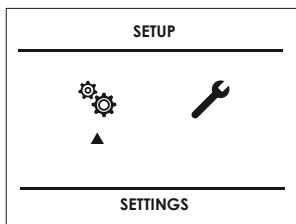

Press ✓ to enter the sub-menu.

③

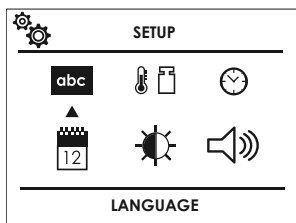

Select the setting you want to change, adjust as needed then press ✓ to confirm.

FIRST USE

Conditioning the oven

It is important that you condition the oven before using it for cooking. Conditioning will burn off any manufacturing residue and ensure you get the best results from the start. Ensure the kitchen is well ventilated before beginning.

①

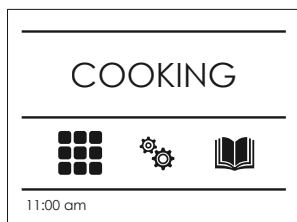

Enter the **COOKING** menu by locating  and pressing ✓ to select.

②

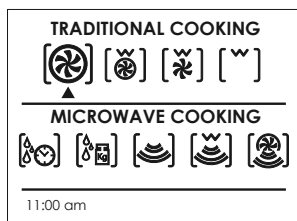

Press ✓ to select **TRUE CONVECTION**.

③

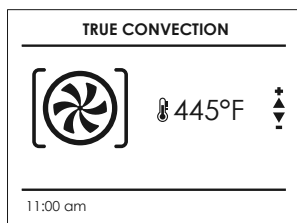

Set the temperature to 445°F (230°C) for 30 minutes.

After conditioning

There will be a distinctive smell and a small amount of smoke during the conditioning process as manufacturing residue is burnt off. This is normal. Once cooled, wipe out the oven with a damp cloth and mild detergent, and dry thoroughly.

Conditioning accessories

Before using the accessories for the first time, clean carefully with hot water, dishwashing liquid and a soft cloth.

Selecting and using a function

1

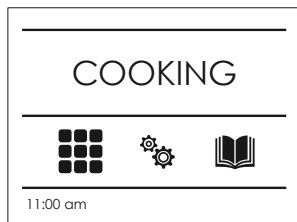

Enter the function menu by locating  and pressing ✓ to select.

2



Navigate to the desired cooking mode and press ✓ to select.

3

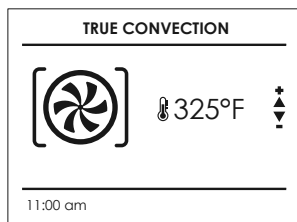

Use the ▲ ▼ to adjust the temperature before pressing ✓ to begin cooking.

If no temperature is selected after 10 seconds, the default temperature will be used.

To pause cooking, press ✓ at any point. Press ✓ to resume.

4

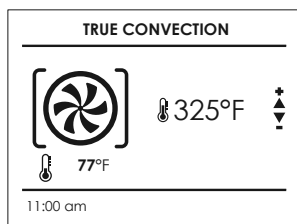

When preheating, the current temperature will be shown in the display alongside the preheat icon. When the set temperature is reached a tone will sound and the temperature value disappears from the display.

FIRST USE

Editing or cancelling cooking



Changing the temperature

Press ✓ then ✕. Select  and change the temperature by pressing ▲▼. Press ✓ to confirm.

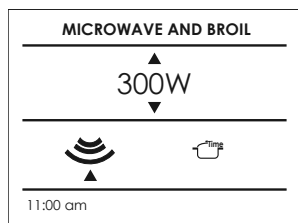

Changing the power

Press ✓ then ✕. Select  and change the power by pressing ▲▼. Press ✓ to confirm.



Changing the function

Press ✓ then ✕. Use ◀▶ to navigate to a new function and press ✓ to confirm.

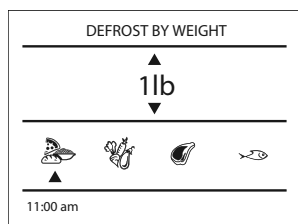

Changing the weight*

Press ✓ then change the weight by using ▲▼. Press ✓ to confirm.

*Only available when using **DEFROST BY WEIGHT**.

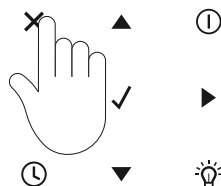

Cancelling cooking

To cancel cooking, press ✓ then ✕ at any time.

USING THE OVEN LIGHT

The oven lights will turn on automatically when the door is opened or a cooking mode has started. During cooking, the lights will automatically dim after three minutes.

Turning the oven light ON or OFF

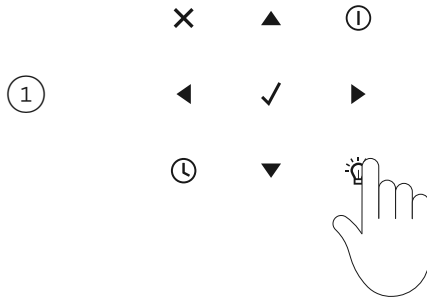

Press  at any time, or open the door.

USING THE TIMER

The timer does not turn the appliance on or off. If you want to turn the oven off automatically, refer to the 'Automatic cooking' section.

The timer can be set for up to 12 hours and 59 minutes and is shown in the status bar as HR:MIN, before switching to MIN:SEC for the last minute.

When the time is complete, 00:00 will show in the status bar and a tone will sound.

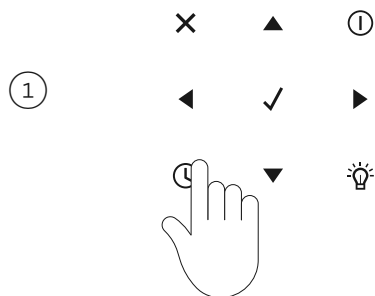

Press ⌚ and set the desired time using ▲▼.

To switch between hours and minutes use ▶◀.

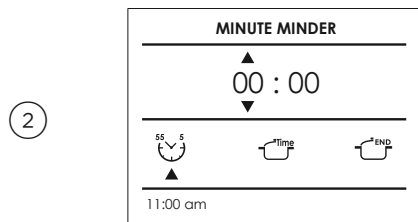

To confirm, press ✓.



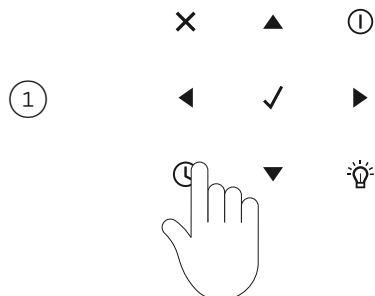

Editing or cancelling the timer







Press and hold ⌚.

COOKING GUIDE

All oven functions default to the recommended temperature, these can be altered at any time.

CONVECTION FUNCTION	DEFAULT TEMPERATURE		TEMPERATURE RANGE	
	°F	°C	°F	°C
 TRUE CONVECTION	330	165	120-445	50-230
 RING AND BROIL	410	210	120-445	50-230
 CONVECTION BROIL	330	165	120-445	50-230
 BROIL	445	230	120-445	50-230

MICROWAVE FUNCTION	DEFAULT TEMPERATURE			TEMPERATURE RANGE		
	WATT	°C	°F	WATT	°C	°F
 MICROWAVE COOKING	900			150-900		
 MICROWAVE AND BROIL	300	200	400	150-450		
 MICROWAVE AND RING	300	100	210	150-450	50-200	120-450
 DEFROST BY TIME	150					
 DEFROST BY WEIGHT	150					

COOKING GUIDE

UTENSILS & COVERINGS	MICROWAVE	CONVECTION BROIL, SLOW COOK	HIGH MIX/ROAST LOW MIX/BAKE
Aluminum foil	Yes Keep foil at least 1" (25mm) from walls of oven.	No	No
Aluminum containers	Yes. Can be used if ¾ filled with food. Keep 1" (25mm) away from walls and do not cover with foil.	Yes. Broil-no cover	Yes. Can be used if ¾ filled with food. Keep 1" (25mm) away from walls and do not cover with foil.
Browning dish	Yes Do not exceed recommended preheating time. Follow manufacturer's directions.	No	No
Glass ceramic (Pyroceram®)	Yes	Yes	Yes
Glass, heat-resistant	Yes	Yes	Yes
Glass, non-heat-resistant	No	No	No
Lids, glass	Yes	Yes Broil with no cover	Yes
Lids, metal	No	Yes Broil with no cover	No
Metal cookware	No	Yes	Yes Do not use metal covering.
Metal, misc: dishes with metallic trim, screws, bands, handles. Metal twist ties	No	No	No
Oven cooking bags	Yes Good for large meats or foods that need tenderising. Do not use metal twist ties.	Yes Broil with no cover	Yes Do not use metal twist ties.
Paper plates	Yes For reheating.	No	No

COOKING GUIDE



UTENSILS & COVERINGS	MICROWAVE	CONVECTION BROIL, SLOW COOK	HIGH MIX/ROAST LOW MIX/BAKE
Paper towels	Yes To cover for reheating and cooking. Do not use recycled paper towels which may contain metal filings.	No	No
Paper, ovenable	Yes	Yes For temperatures up to 400°F (205°C). Do not use for broiling.	Yes For temperatures up to 400°F (205°C).
Microwave safe plastic containers	Yes Use for reheating and defrosting. Some microwave-safe plastics are not suitable for cooking foods with high fat and sugar content. Follow manufacturer's directions.	No	NO
Plastic, thermoset*	Yes	Yes Are heat resistant up to 425°F (218°C). Do not use for broiling.	Yes
Plastic wrap	Yes Use brands specially marked for microwave use. DO NOT allow plastic wrap to touch food. Vent so steam can escape.	No	NO
Pottery, porcelain stoneware	Yes Check manufacturer's recommendation for being microwave safe.	Yes	Yes Must be microwave and oven safe
Styrofoam	Yes For reheating.	No	No
Wax paper	Yes Good covering for cooking and reheating.	No	No
Wicker, wood, straw	Yes May be used for short periods of time. Do not use with high fat or high sugar content foods. Could char.	No	No

AUTOMATIC COOKING

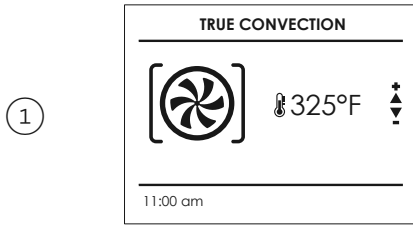

To use automatic cooking modes ensure the clock is displaying the correct time. Refer to 'First use' for setting the time. Use the automatic cooking function to set the oven to turn off after a set length of time.

Setting automatic cooking



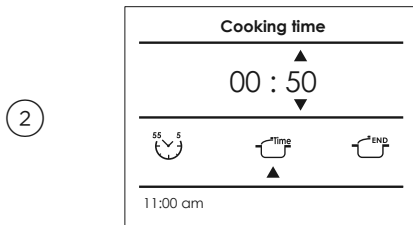



Select the cooking mode and temperature you wish to use and press , then select  by pressing .

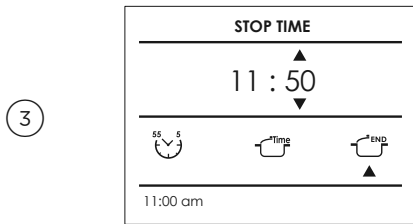

Set the desired cook time by using  . Press .

The maximum cooking time is 12 hours.



Select  and set the desired stop time by using  . Press .

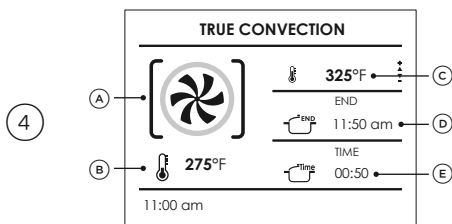

During cooking, the following will be displayed:

- (A) function
- (B) current temperature
- (C) target temperature
- (D) end time
- (E) time elapsed

When the end time is reached

The oven will automatically turn off and a tone will sound.

AUTOMATIC COOKING

Editing or cancelling automatic cooking

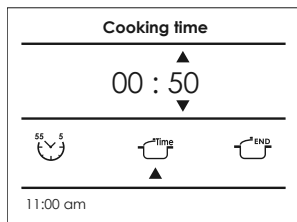

Changing the cook time

Press and change the desired cook time using . Press to confirm.

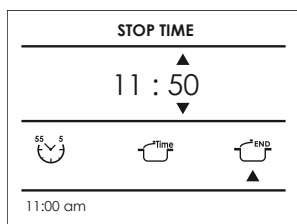

Changing the end time

Press , then select and change the desired cook time using . Press to confirm.

MICROWAVE COOKING

Setting defrost by time

1



Using ◀ ▶, select . Press ✓ to confirm.

2

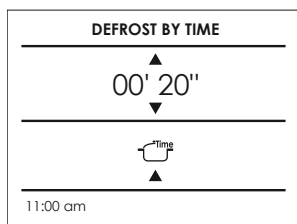

Set the defrost time by using ▲ ▼.
Press ✓ to confirm.

3

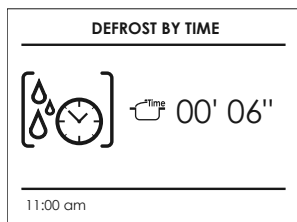

During defrosting, a countdown will be shown on the display. The remaining time can be changed at anytime by pressing ▲ ▼.

When the end time is reached

A message will appear on the display.

RECIPES



The recipe function has been designed to help achieve optimal oven conditions for cooking a particular food type. When in use, the function, temperature and time are set automatically and any additional details are displayed on screen.

Recipes can be added to a personal recipe list for quick access, refer to 'Saving a recipe' for details.

Using recipes



1



Press  then press .





2

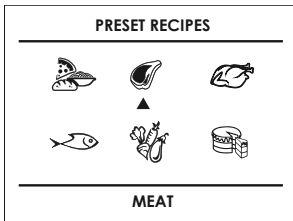

Press   to choose from **PRESET** or **PERSONAL**. Press  to confirm.

3



Select the desired food type by pressing   and  . Press  to confirm.

RECIPES

4

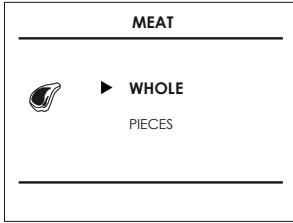

Press ▲ ▼ to refine food selection.
Press ✓ to confirm.

5

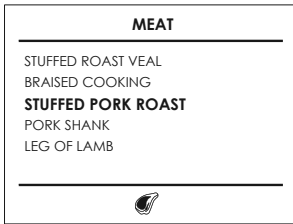

Select a recipe by pressing ▲ ▼.
Press ✓ to confirm.

6

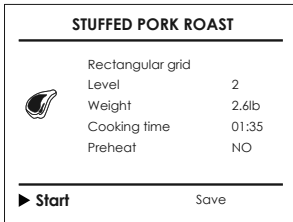

Press ✓ to start cooking.

7

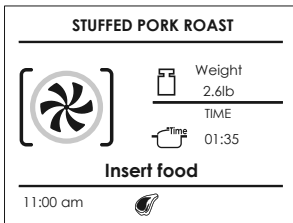

Follow the onscreen guidance.

When recipe is complete

The oven will automatically turn off
and a tone will sound.

RECIPES

Saving a recipe

Commonly used recipes can be adjusted and saved for quick access. These can be found under **PERSONAL** recipes.

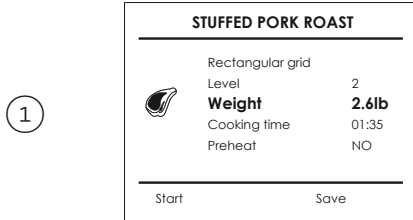

Use ▲ to navigate to weight or cook time.
Press ✓ to confirm.

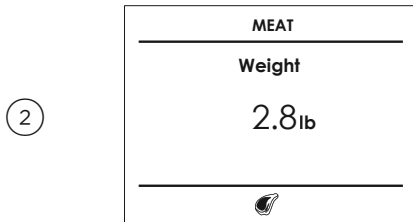

Set the desired weight and cook time
before pressing ✓ to confirm.

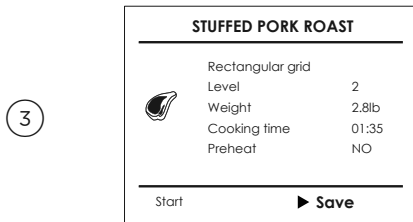

Use ▲ to navigate to **SAVE**.
Press ✓ to confirm.

Removing a personalized recipe



Select the recipe you want to remove
and press ◀. Press ▶ to select **YES**
and ✓ to confirm.

EVENT LOGS

The system menu allows access to event logs. This section displays any recorded errors, faults and all voltage information. These codes can be communicated to Customer Care in the event of a product fault.

①

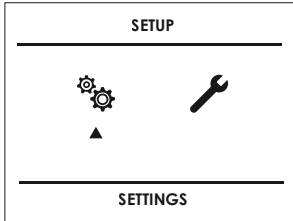

Select  and press  to confirm.

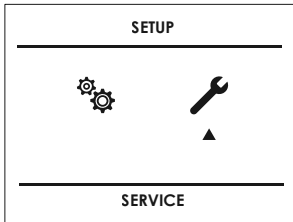

②

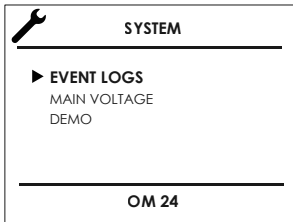

Select  and press  to confirm.

③



Press   choose from the available options.
Press  to confirm.

TROUBLESHOOTING

If there is a problem with your oven, please check the following, before contacting a Fisher & Paykel trained and supported service technician or Customer Care.

PROBLEM	POSSIBLE CAUSES / SOLUTION
Food browns unevenly.	Oven is not preheated.
	Aluminum foil on oven rack or oven bottom.
	Baking pan is too large for recipe.
	Baking pans are touching each other or oven walls.
Food too brown on bottom.	Oven is not preheated.
	Using glass, dull or darkened metal pans.
	Incorrect rack position.
	Baking pans are touching each other or oven walls.
Food is dry or has shrunk excessively. Food is baking or roasting too slowly.	Oven temperature too low.
	Oven not preheated.
	Oven door opened frequently during cooking.
	Food is tightly sealed with aluminum foil.
	Pan size too small.
Pie crusts do not brown on bottom or have soggy crust.	Baking time is not long enough.
	Using shiny steel pans.
	Rack position is incorrect.
	Oven temperature is too low.
Cakes pale, flat and may not be cooked inside.	Oven is temperature too low.
	Baking time is not long enough.
	The cake has been tested too soon.
	The oven door has been opened too often during baking.
	Baking pan size may be too large.

TROUBLESHOOTING

PROBLEM	POSSIBLE CAUSES / SOLUTION
Cakes high in middle with crack on top.	Baking temperature is too high. Baking time is too long. Baking pans are touching each other or oven walls. Rack position is incorrect. Baking pan size may be too small. Batter is over-mixed
Pie crust edges too brown.	Oven temperature too high. Edges of crust is too thin.
Other F__ Error appears in the display window.	Remove power and turn it back on again after a few seconds. If condition persists, note the code number (refer to 'Event logs') and contact Customer Care or a Fisher & Paykel trained and supported service technician.
The oven display won't turn on.	Turn off power at the main power supply, then turn the power back on. If this does not resolve the issue, call Customer Care or a Fisher & Paykel trained and supported service technician.
The cooling fan continues to run after the oven is turned off.	The fan will turn off automatically when the electronic components have cooled sufficiently.
Oven is not heating.	Check the circuit breaker or fuse box to your house. Check that power is being supplied to the oven. Make sure the oven temperature has been selected.
Oven is not cooking evenly.	Refer to 'Microwave Cooking' for recommended rack position. Always reduce recipe temperature by 25°F (15°C) when baking with TRUE CONVECTION mode.
Oven light is not working properly.	Check that power is being supplied to the oven. Refer to the 'First use' section of this user guide.
Clock and timer are not working properly.	Make sure there is proper electrical power to the oven.
Excessive moisture.	Using the convection mode will eliminate any moisture in the oven.
Turning off demo mode.	To disable the function, press the arrows ◀ ▶ to enter the DEMO display page and select off. Confirm your selection by pressing ✓.

WARRANTY AND SERVICE

Before you call for service or assistance

Check the things you can do yourself. Refer to the installation instructions and your user guide and check that:

- Your product is correctly installed.
- You are familiar with its normal operation.
- Model number
- Serial number
- Date of installation

If after checking these points you still need assistance or parts, please refer to the Service & Warranty book for warranty details and your nearest Service Centre, Customer Care, or contact us through our website www.fisherpaykel.com or email: customer.care@fisherpaykel.com.

Complete and keep for safe reference:

Mode _____

Serial No. _____

Purchase Date _____

Purchaser _____

Dealer _____

Suburb _____

Town _____

Country _____

FISHERPAYKEL.COM

© Fisher & Paykel Appliances 2021. All rights reserved.

The models shown in this guide may not be available in all markets
and are subject to change at any time.

The product specifications in this guide apply to the specific products and
models described at the date of issue. Under our policy of continuous product
improvement, these specifications may change at any time.

For current details about model and specification availability in your country,
please go to our website or contact your local Fisher & Paykel dealer.

592409A 11.21