

# **FISHER & PAYKEL**

## **INTEGRATED REFRIGERATION**

---

**INTEGRATED**

RS2474BRU Models

**INSTALLATION GUIDE**

**US CA**



**⚠ WARNING!**



**Electric Shock Hazard**

Failure to follow this advice may result in electrical shock or death.

- Read and follow the safety and warnings before operating this appliance.

**⚠ WARNING!**



**Sharp Edge and Pinch Point Hazard**

Failure to follow this advice may result in injury.

- Take care: panel edges may be sharp.
- Do not put fingers in the drawers when closing.

**⚠ WARNING!**



**Tip Hazard**

Failure to follow this advice may result in damage or personal injury.

- This product may tip up until it is fully installed. Keep children away and take care.
- This appliance is top-heavy and must be secured to prevent the possibility of tipping forward.

**To ensure that the appliance is stable under all loading conditions:**

- The anti-tip bracket and fittings supplied must be installed by a professional installer according to the installation steps in this guide.

**⚠ WARNING!**



**Weight Hazard**

Failure to follow this advice may result in damage or personal injury.

- The appliance is heavy. Please ensure adequate care is taken when installing the appliance.

**READ AND SAVE THIS GUIDE**

**WARNING!**

To avoid hazard, follow these instructions carefully before installing or using this appliance.

- Please make this information available to the persons installing the appliance.
- Assume all electrical parts are live.
- Disconnect power supply before servicing and installation.

**SAVE THESE INSTRUCTIONS**

The models shown in this installation guide may not be available in all markets and are subject to change at any time. For current details about model and specification availability in your country, please go to our website [www.fisherpaykel.com](http://www.fisherpaykel.com) or contact your local Fisher & Paykel dealer.

## PRIOR TO INSTALLATION

- The appliance has front and rear rollers to easily move forward and backward. Do not move the appliance sideways to avoid damaging the rollers or the floor covering/surface.
- Ensure your appliance is not exposed to any heat generating appliance eg cooktop, oven or dishwasher.
- The appliance must be installed by a qualified installer, or Fisher and Paykel trained and supported service technician to avoid faulty electrical and plumbing connections.
- All connections for electrical power and grounding must comply with local codes and ordinances and be made by licensed personnel when required.
- All plumbing meeting local codes also required.
- Avoid installation of the appliance/s under a ground fault circuit interrupter (GFCI).
- Ensure the appliance is installed properly. Improper installation that results in appliance failure is not covered under the appliance warranty.

### ELECTRICAL/PLUMBING

- Electrical and water supply connections for these appliances can be located in an adjacent area or unit (cabinet or cupboard) that is easily accessible in case of repair or disconnection.
- Ensure an isolating switch is available if electrical connection is not accessible.
- Ensure an isolation valve is available if water connection is not accessible.
- Contact an electrical and/or a plumbing professional if you are uncertain the electrical and/or plumbing conditions for installation.

## DURING INSTALLATION

- Ensure the door of the appliance is closed when rolling into the cabinetry.
- For flush installation, ensure the door panels are installed flush with cabinetry front surface. Ensure appliance is properly centred.
- Ensure floor is protected to prevent damage.
- All four corners of the appliance must be supported firmly on the floor to eliminate any movement. Installing the appliance on a soft, uneven, or not level floor may cause twisting and poor door sealing.
- Use low speed, low torque setting when using a powered driver for the screws when fixing or aligning the product.

## INSTALLATION MILESTONES



★ Milestone indicator

These milestones represent areas throughout that are pivotal to an optimal installation outcome. These steps require additional installer attention and should be quality checked once completed.

### MILESTONE LINKS

- ★ Check anti-tip bracket is correctly installed.
- ★ Remove cap from valve before connecting the hose and tightening.
- ★ Connect to services and check for leaks.
- ★ Push into alcove. Ensure depth gauges touch the alcove front.
- ★ Adjust product height. Ensure all feet engage with the floor and the upper bracket touches the alcove.
- ★ Expand spacers. Ensure no gaps are present.
- ★ Recheck all gaps and any clashing.
- ★ Installer checklist.

# PARTS REQUIRED

## INSTALLATION KIT (INTERNAL BOX)

### Install kit H - UI Trim kit



Trim UI RS24 non Hinge RH



Trim UI RS24 non hinge LH



Trim UI RS24 Hinge LH



Trim UI RS24 Hinge RH



Bolt limiting hinge K08

### Install kit A - Bracket anti tip assy



Anti-tip bracket



Screw WS #10X35 T17 WFR PH ZP



Plug masonry SP630#10X30MM

### Install kit F - Kit panel attach



Slider bracket skin DR 60cm



Spacer bracket side DR 60cm



Bracket trim side door 24"

### Install kit G - Kit screw panel attachment

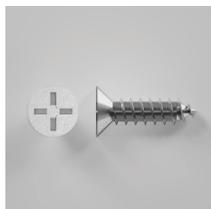

Screw ST 8X5/8 CSK PH AB ZP

### Install kit C - Kit door screw



Screw MC M5X12 MSH PH ZP

### Install kit E - Kit screw alcove attachment



Twinthread screw 8GX19

### Install kit D - Kit flow divider



Door seal flow divider



Screw SD #7X13 PAN PH ZP



Cap divider flow door



Ball hex key M4



Spanner door



L key combi PH2 T25

### Install kit B - Kit hinge spacer & depth gauges



Assy hinge spacer A

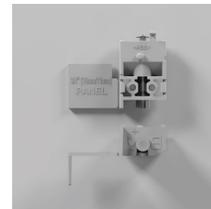

Assy hinge spacer B



Depth gauge non hinge

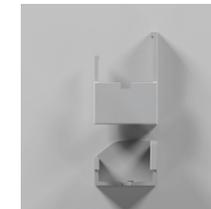

Cover hinge spacer A



Cover hinge spacer B



Screw hinge spacer

### Miscellaneous parts

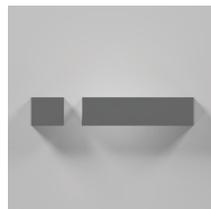

Blocker air bypass kickstrip

## PARTS REQUIRED

### WATER FILTER KIT



Water filter  
(comes fitted to product)



Braided hose, 7/16" x 24  
UNS

### JOINER KIT

To be ordered separately for multiple installation.

Joiner kit A  
bracket joiner plinth



Screw M5X12 PH MT  
STL ZN

Joiner kit B  
bracket joiner top

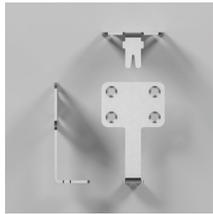

Bracket dual connection  
top

Joiner kit C  
bracket joiner rear



Screw 8GX16 mush  
washer HD

Miscellaneous



Trim centre dual install  
24"



Bracket dual plinth FNT  
(x2)



Screw M5X12 CSKPH NP



Bracket dual plinth FNT

### MISCELLANEOUS ITEMS (MI) PACK



Safety booklet



Service and Warranty

### TRIM KIT



EXTRUSION PANEL  
DOOR B BTM 24"



TRIM SIDE HINGE DR B  
BTM 24"



TRIM SIDE HINGE DR B  
TOP 24"



EXTRUSION PANEL  
DOOR B TOP 24"



TRIM TOP DOOR 24"



MTG PALTE TOE KICK  
RS24



Template Panel Door  
B 24"

## OPTIONAL ACCESSORIES

### HANDLES

#### Round handle set

Round handle (2) M5x25 Hex screw (4)



MODEL	DESCRIPTION
AHSRDB19	Round Handle Kit

#### Square Fine handle set

Square fine handle (2) M5x25 Hex screw (4)



MODEL	DESCRIPTION
AHD5RDB19	Square fine handle kit SS
AHD5RDB19B	Square fine handle kit BLK

#### Professional round flush handle set

Round flush handle (2) M5x25 Hex screw (4)



MODEL	DESCRIPTION
AHP3RDB19	Professional round flush handle kit

### DOOR PANELS

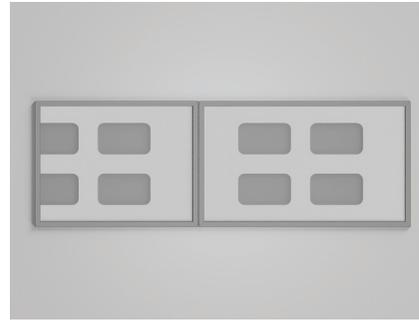

MODEL	DESCRIPTION
RD6019BR	Right hinge door panel kit
RD6019BL	Left hinge door panel kit

### TOE KICK

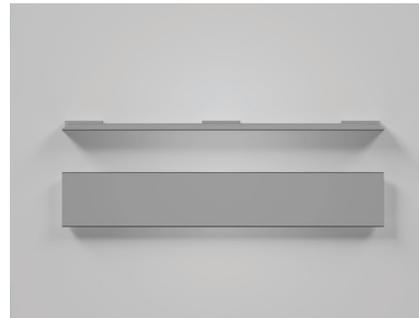

MODEL	DESCRIPTION
AKRS06010	Single install toe kick
AKRS12010	Dual install toe kick
AKRS18010	Triple install toe kick

## TOOLS REQUIRED

### Required tools

Not supplied and must be provided by the installer.



Powered driver



Flathead screwdriver



Measuring tape



Cross-head screwdriver



Cutter



Hacksaw



Hand truck



Socket 8mm



Nut driver

### Supplied tools



Spanner



L key combi  
PH2 T25



M4 Ball allen key



# PRODUCT AND CAVITY DIMENSIONS

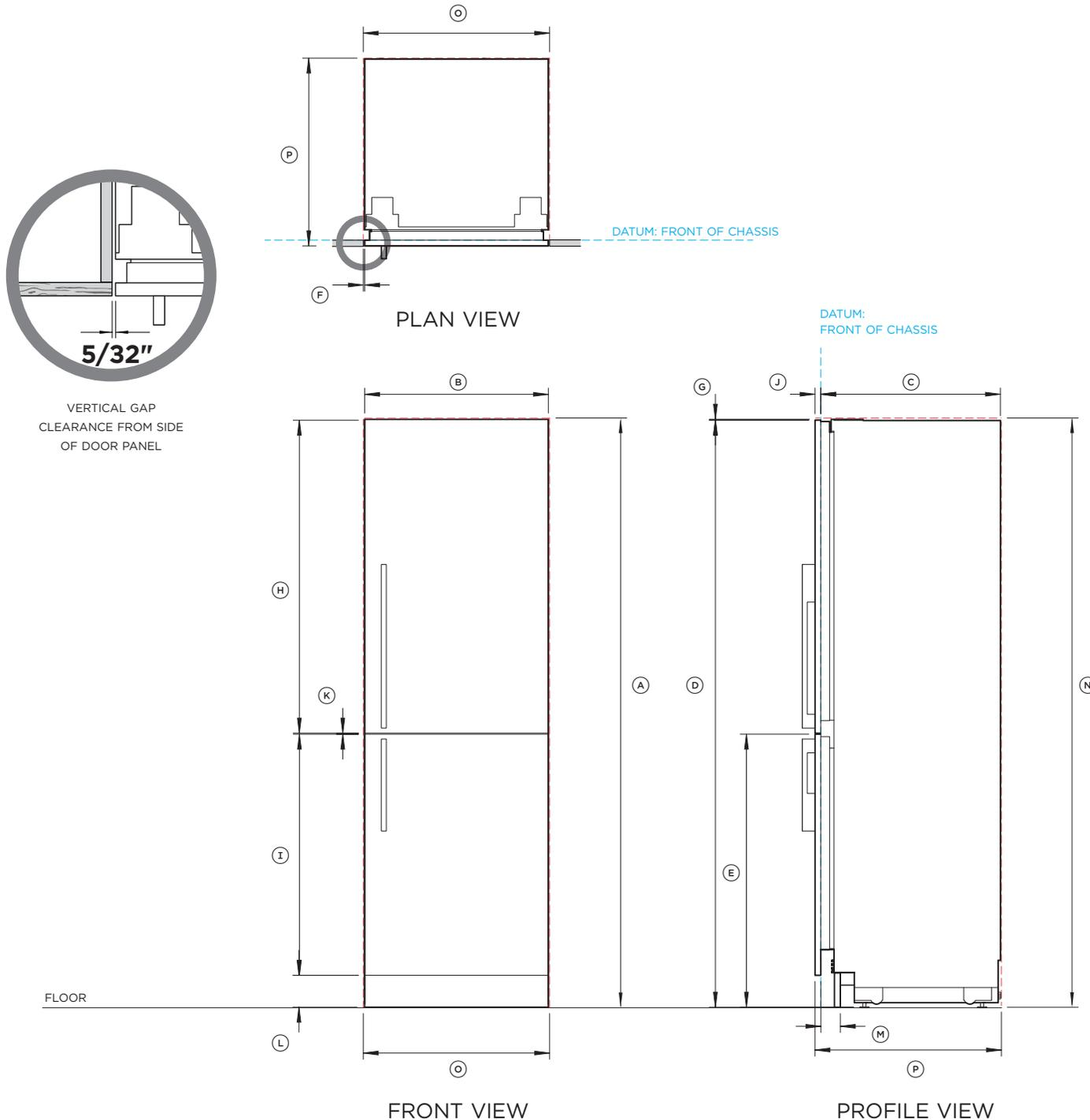

## RS2474BRU1 with Stainless Steel Panels RD2474BR, Handle Kit AHD5RDS74B and Stainless Steel Toe Kick Panel AKRS2304

Left hand hinge is a mirrored version of the image shown. Left hand hinge can be achieved using supplied parts.

## RS2474BRU1 with Stainless Steel Panels RD2474BL, Handle Kit AHD5RDS74B and Stainless Steel Toe Kick Panel AKRS2304

Product Dimensions	in	mm
A Overall height of product	74	1880
B Overall width of product	23 5/16	592
C Overall depth of product (excl. front door panels)	22 13/16	579
D Height from top of top door panel to floor	73 7/8	1877
E Height from top of bottom door panel to floor	34 3/8	873
F Minimum cabinetry clearance from side of door panel	5/32	4
G Minimum cabinetry clearance from top of door panel	1/8	3
H Height of top door panel	39 13/32	1001
I Height of bottom door panel	30 3/8	771
J Depth of door panels	3/4	19
K Gap between door panels	1/8	3
L Height from floor to bottom of bottom door panel	4	102
M Depth of toe kick (excl. front door and toe kick panels)	2-4	50-100

Cavity Dimensions	in	mm
N Overall height of cavity	74	1880
O Overall width of cavity	23 5/8	600
P Minimum overall depth of cavity:		
• When services are located outside of cavity (shallow)	23 5/8	600
• When services are located in the cabinet above the cavity	24	610
• When services are located at rear of cavity (deep)	25 9/16	650

Note: Product shown installed on the floor. Slide into cabinetry position. Alternatively can be installed on a plinth. Adjust your cavity height accordingly. Dimensions may vary by  $\pm 1/16"$  (2mm)

INDICATES CAVITY CLEARANCES - - - - -  
INDICATES PRODUCT DATUM - - - - -

# PRODUCT AND CAVITY DIMENSIONS

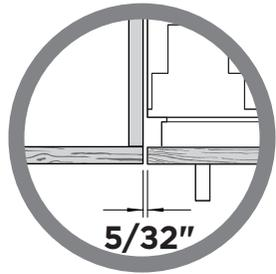

VERTICAL GAP  
CLEARANCE FROM SIDE  
OF DOOR PANEL

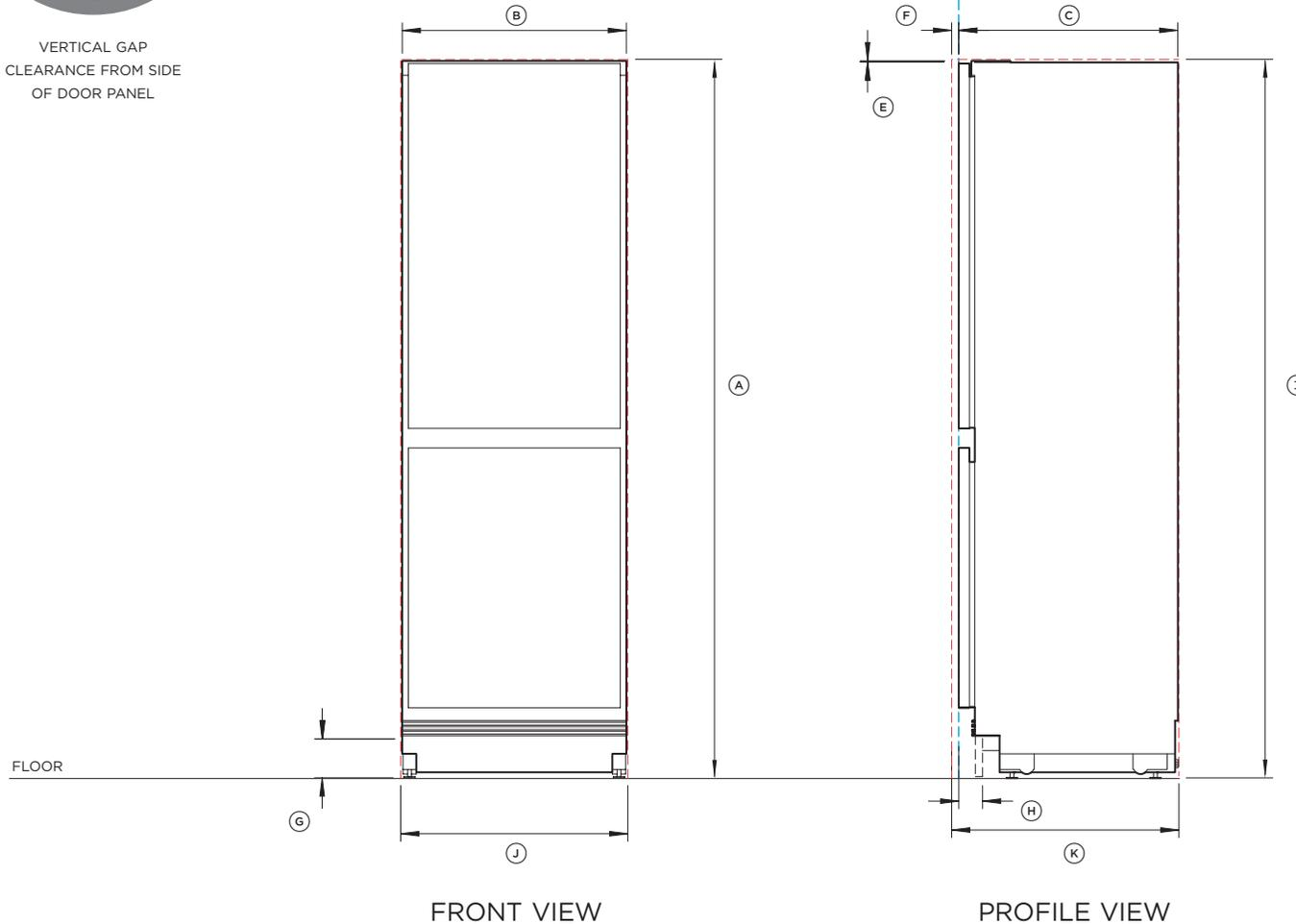
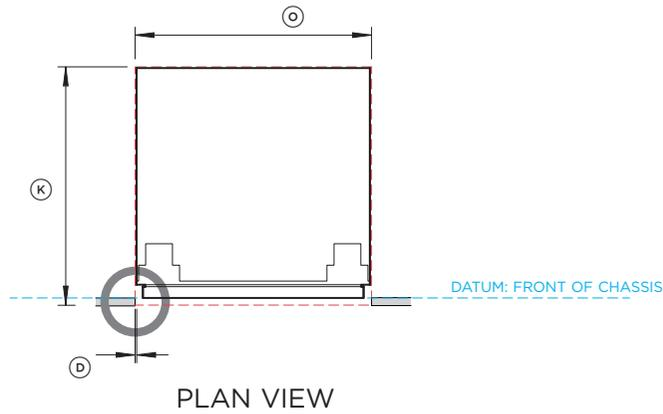

NOTE: Left hand hinge is a mirrored version of the image shown. Left hand hinge can be achieved using supplied parts.

Product Dimensions	in	mm
A Overall height of product	74	1880
B Overall width of product	23 5/16	592
C Overall depth of product	22 13/16	579
D Minimum cabinetry clearance from side of door panels*	5/32	4
E Minimum cabinetry clearance from top of door panel*	1/8	3
F Depth of door panels*	5/8-3/4	16-19
G Height of toe kick panel*	4	100
H Depth of toe kick (excl. front door and toe kick panels*)	2-4	50-100

Cavity Dimensions	in	mm
I Overall height of cavity	74	1880
J Overall width of cavity	23 5/8	600
K Minimum overall depth of cavity:		
• When services are located outside of cavity (shallow)	23 5/8	600
• When services are located in the cabinet above the cavity	24	610
• When services are located at rear of cavity (deep)	25 9/16	650

Note: Product shown installed on the floor. Slide into cabinetry position. Alternatively can be installed on a plinth. Adjust your cavity height accordingly.

For custom panel dimensions refer to page 13

\* Custom door panels and toe kick panel to be manufactured and fitted by cabinetmaker.

Dimensions may vary by  $\pm 1/16"$  (2mm)

INDICATES CAVITY CLEARANCES - - - - -  
INDICATES PRODUCT DATUM - - - - -

# CAVITY PREPARATION

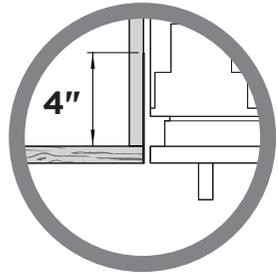

FINISHED RETURN  
CAVITY SIDES & TOP

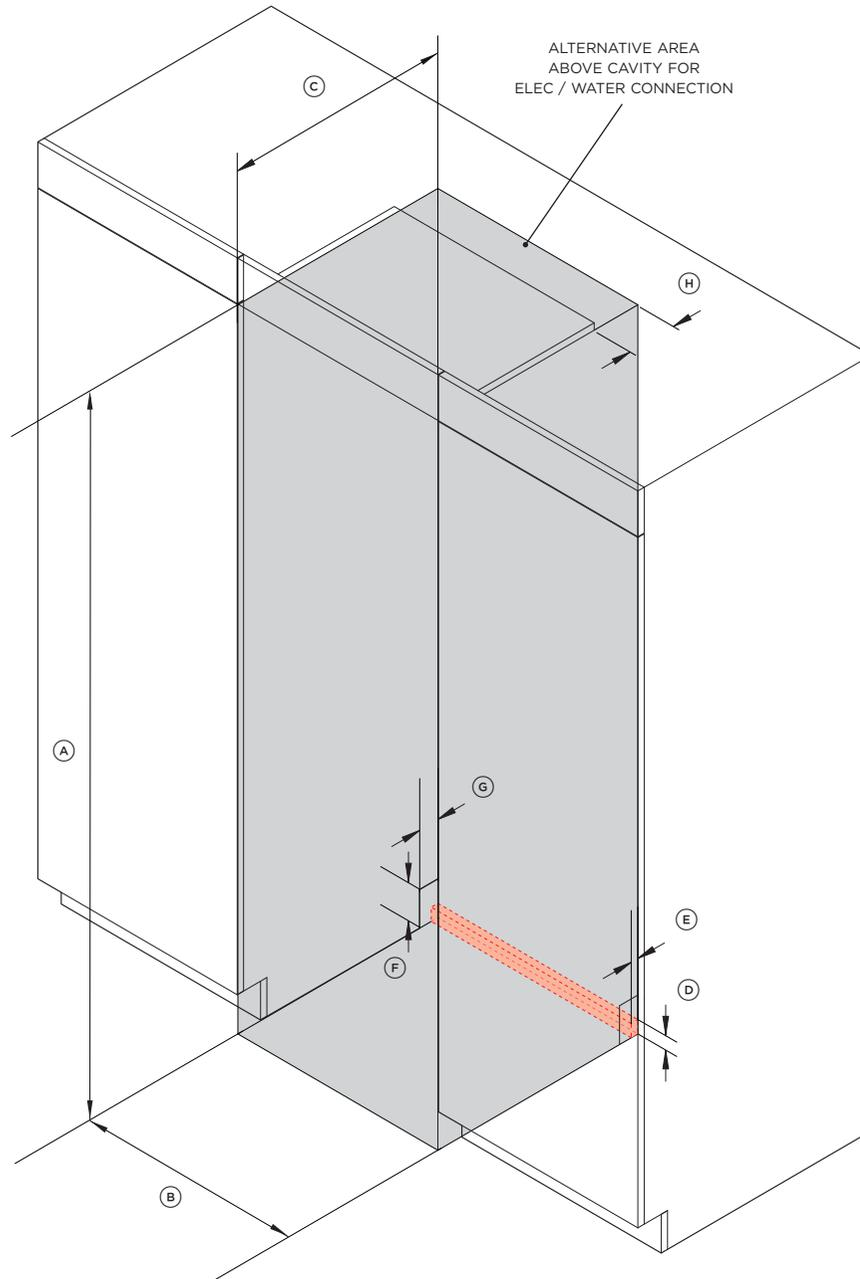

ISO VIEW

NOTE: Left hand hinge is a mirrored version of the image shown.

**For ease of installation, ensure cavity has consistent dimensions top to bottom and left to right.**

Minimum Cavity Dimensions	in	mm
Ⓐ Overall height of cavity	74	1880
Ⓑ Overall width of cavity	23 5/8	600
Ⓒ Minimum overall depth of cavity:		
• When services are located outside of cavity (shallow)	23 5/8	600
• When services are located in the cabinet above the cavity	24	610
• When services are located at rear of cavity (deep)	25 9/16	650
Minimum required finished return	4	100

Electrical / Plumbing Supply Dimensions	in	mm
Ⓓ Overall height of supply routing area at rear of cavity	1 7/16	37
Overall width of supply routing area at rear of cavity	23 5/8	600
Ⓔ Overall depth of supply routing area at rear of cavity	13/16	20
Ⓕ Height of notch at rear of cavity for services to be routed into adjacent cabinet (either side)	4	100
Ⓖ Depth of notch at rear of cavity for services to be routed into adjacent cabinet (either side)	2 3/16	55
Ⓗ Minimum depth above cavity for services to be routed through	2 3/16	55

Recommended that services are routed to the adjacent cabinet or either side of the product.

Dimensions may vary by  $\pm 1/16"$  (2mm)

# SERVICES

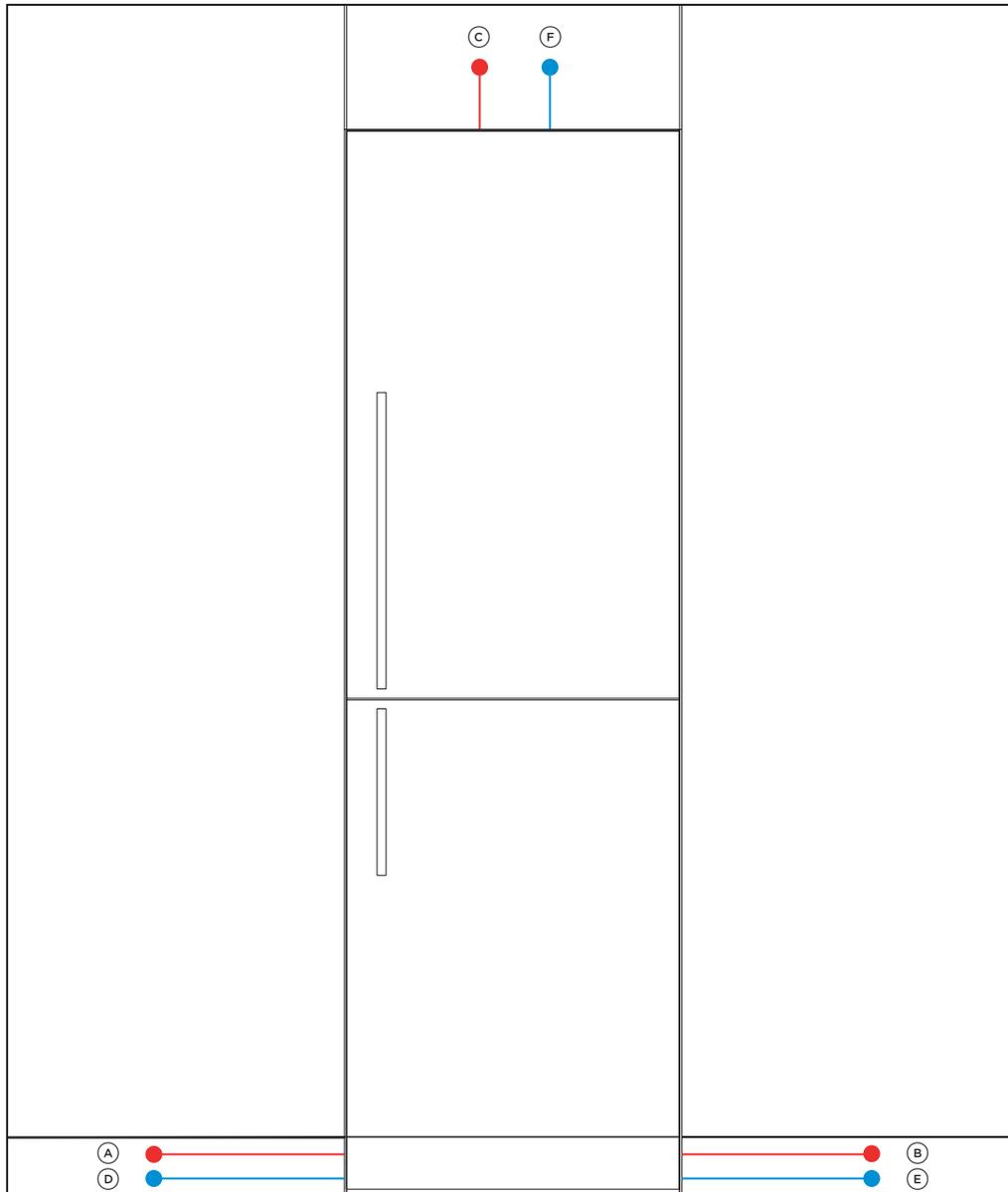

LEFT HAND SIDE

FRONT VIEW

RIGHT HAND SIDE

Specifications	
<b>Electrical</b>	
Supply	115 VAC, 60 Hz
Service	10 amp circuit
<b>Plumbing</b>	
Supply	Braided hose, 7/16" x 24 UNS
Pressure	min 40 psi (150 kPa) max 120 psi (827 kPa) @ 68°F (20°C)

NOTE: Recommended that services are routed to the adjacent cabinet.

Hose and Cord Lengths	in	mm
<b>Electrical</b>		
Ⓐ Power cord length (from the left edge of the product)*	74	1800
Ⓔ Power cord length (from the right edge of the product)*	78 3/4	2000
Ⓒ Power cord length (from the top of the product)*	14 15/16	380
<b>Water</b>		
Ⓓ Water inlet hose length (from the left edge of the product)	96 7/16	2450
Ⓕ Water inlet hose length (from the right edge of the product)	78 3/4	2000
Ⓖ Water inlet hose length (from the top of the product)	27 9/16	700

\* Excluding plug.

## CUSTOM PANEL DIMENSIONS

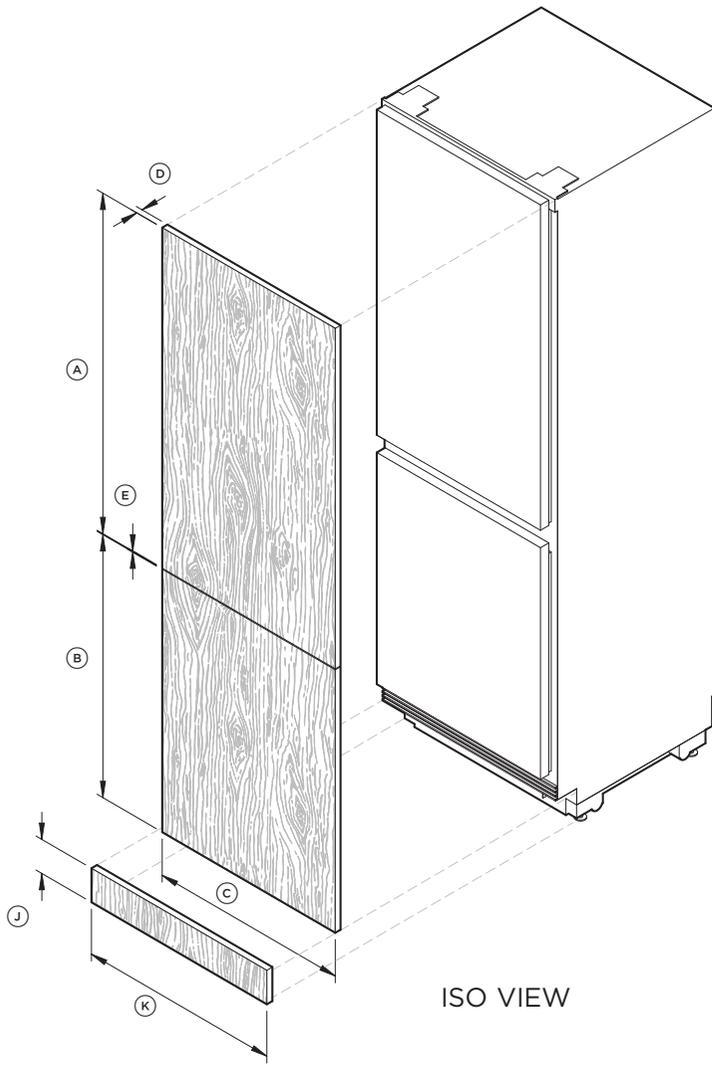

ISO VIEW

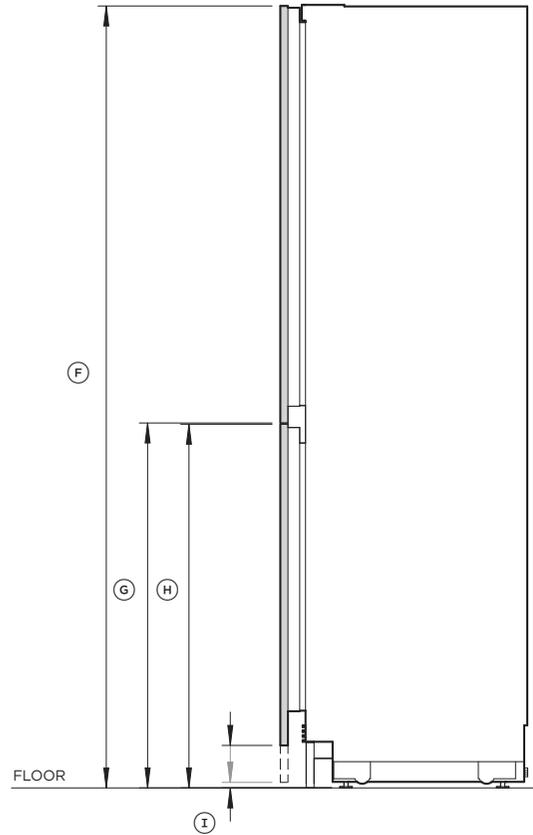

PROFILE VIEW

NOTE: Left hand hinge is a mirrored version of the image shown.  
Left hand hinge can be achieved using supplied parts.

Custom Panel Dimensions	in	mm
Ⓐ Height of top door panel	39 13/32	1001
ⓑ Height of bottom door panel	28 7/16 -33 3/4	723-858
ⓒ Width of door panel:		
• Single install	23 5/16	592
• Dual install*	23 3/8	594
• Triple install*	23 13/32	594.5
ⓓ Depth of custom panel**	5/8-3/4	16-19
ⓔ Gap between door panels	5/32	3
ⓕ Height from floor to top of top door panel	73 7/8	1877
ⓖ Height from floor to bottom of top door panel	34 1/2	876
ⓗ Height from floor to top of bottom door panel	34 3/8	873
ⓘ Height from floor to bottom of bottom door panel***	9/16 -5 15/16	15-150
ⓙ Height of toe kick panel	4	100
ⓚ Width of toe kick panel****	23 1/2	597
Maximum weight of top door panel*****		
	21lbs	9.5kg
Maximum weight of bottom door panel*****		
	20lbs	9kg

Custom door panels, handles and toe kick panel to be manufactured and fitted by cabinetmaker.

- \* For further details on multiple installation refer to the planning guide
- \*\* At 3/4" (19mm) thickness, we recommend an edge radius of 1/16" (1mm) or more to avoid the possibility of panel clash when opening
- \*\*\* The grille becomes visible at heights over 100mm
- \*\*\*\* Can be continuous
- \*\*\*\*\* Includes weight of handle

# CUSTOM PANEL PREPARATION

REAR VIEW

TOP PANEL

BOTTOM PANEL

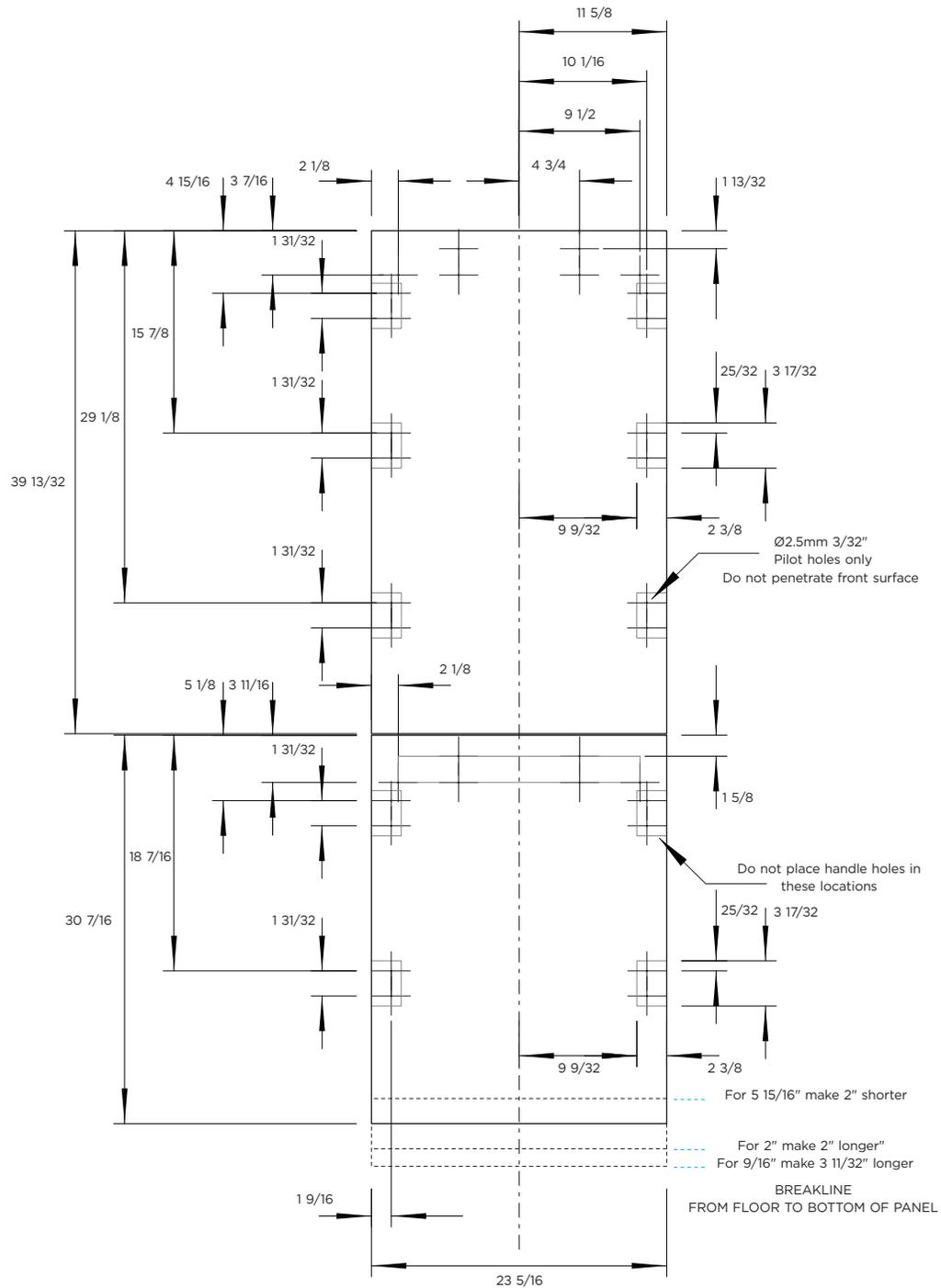

## Custom Panel Preparation

Dimensions are shown in inches (in).

Dimensions apply for the preparation and installation of custom panels

## Handles

Ensure handle screw heads are countersunk into back of panel to avoid interfering with hanging bracket, and clear of side brackets as indicated.

## Dwg & Dxf Files

Dwg and Dxf files of the panel preparation can be downloaded from Trade Resources [www.fisherpaykel.com](http://www.fisherpaykel.com)

## Template

A template for marking and drilling the holes is provided with the product

# DOOR CLEARANCES

## CLEARANCES

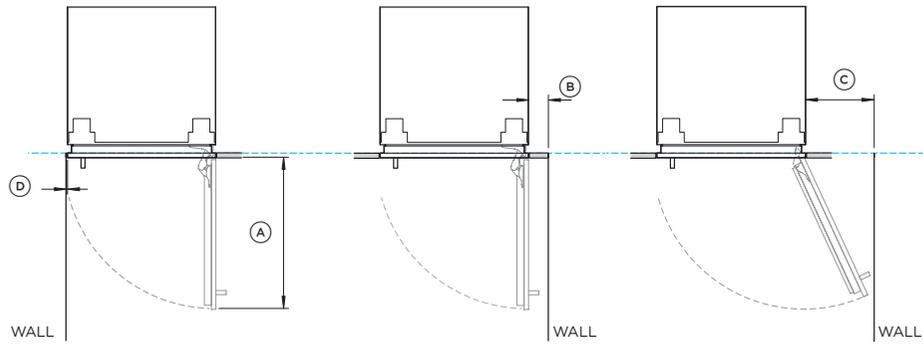

## CONFIGURATIONS

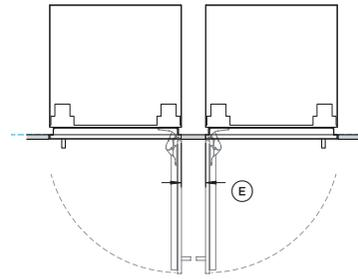

**HINGE TO HINGE**  
Both doors open at the same time  
- requires space between models

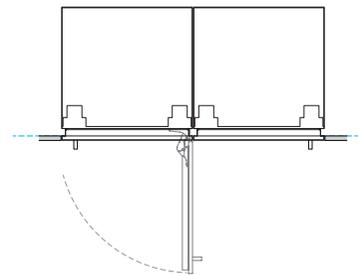

**HINGE TO HINGE**  
Only allows a single door open at a time

## DUAL INSTALL

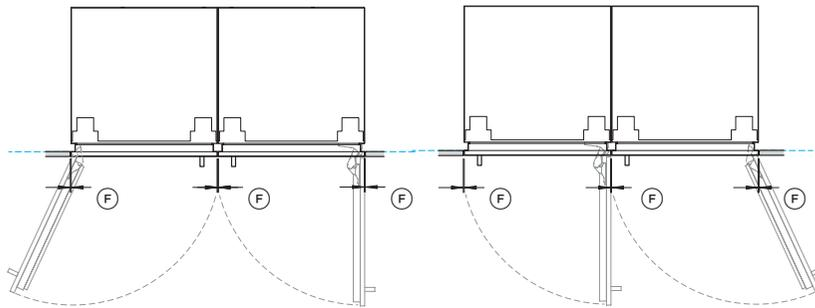

## TRIPLE INSTALL

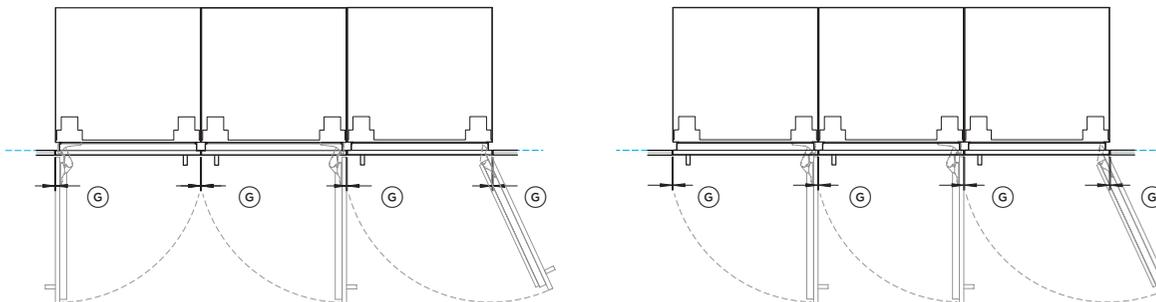

**RS2474BRU1 with Stainless Steel Panels RD2474BR, Handle Kit AHD5RDS74B and Stainless Steel Toe Kick Panel AKRS2304**

Left hand hinge is a mirrored version of the image shown. Left hand hinge can be achieved using supplied parts.

**RS2474BRU1 with Stainless Steel Panels RD2474BL, Handle Kit AHD5RDS74B and Stainless Steel Toe Kick Panel AKRS2304**

Clearance Dimensions	in	mm
Ⓐ Depth of door (90° open, measured from front of cabinetry)	23 5/8	600
Ⓑ Minimum door clearance to adjacent wall (90° - reduced internal access)* **	3 1/8	80
Ⓒ Minimum door clearance to adjacent wall (115° - full internal access)* **	10 3/4	273
Ⓓ Minimum cabinetry clearance from side of door panel to adjacent wall (non hinge side)	5/32	4
Ⓔ Minimum clearance between products when opening hinge to hinge. Allowing both doors to open at the same time**	4	100
<b>Minimum Door Clearance (Vertical Gap)</b>		
Ⓒ Dual Install:		
• Stainless steel door panels (gaps equalized during installation)	3/16	5
• Custom panels (width of custom panel increased to maintain 4mm gap across multiple products)***	5/32	4
Ⓒ Triple Install:		
• Stainless steel door panels (gaps equalized during installation)	1/4	6
• Custom panels (width of custom panel increased to maintain 4mm gap across multiple products)***	5/32	4

\* Use hinge limiting pin to restrict door opening to 90° where necessary  
 \*\* Minimum dimensions shown are for the contemporary handle kit AHD5RDSF. Custom panel and handle details need to be taken into account.  
 \*\*\* Refer to Custom Panel Dimensions and Multiple Install pages for further details.

INDICATES CAVITY CLEARANCES - - - - -  
 INDICATES PRODUCT DATUM - - - - -

..... CHECK CAVITY .....

①



Measure alcove dimensions. Ensure all minimum specs have been met.

If alcove depth is greater than 24" (610mm), a spacer will need to be installed alongside the anti-tip bracket. Refer to page 18 for details.

②



Check alcove is square and is secured to the wall. Ensure front of alcove is square to the top of the alcove and the floor is flat.

③



Ensure a finished return has been created.

④



Ensure services are accessible and correctly installed. Refer to 'services' for details.

..... CHECK PANELS .....

①



Ensure all door and toe kick panels are square and set up to the correct specifications. Refer to 'custom panel preparation' for details.

②



Ensure all bracket and handle holes have been pre-drilled. Refer to 'custom panel preparation' for details.



## UNPACK PRODUCT

- Keep all packing materials until the unit has been inspected.
- Inspect the product to ensure there is no shipping damage. If any damage is detected contact the dealer or retailer you bought the product from to report the damage.
- Fisher & Paykel is not responsible for shipping damage.

①



Cut straps, lift the top cap off and cut down the side of the carton to remove. Dispose of packaging responsibly.

②



Remove all pre packaged parts and set aside. Do not discard.

③



Push the grille flap to open and unscrew the two screws behind the flap and five on the grille. Set screws aside. Open the door and pull the grille outwards from the product.

④



Using a crosshead screwdriver, unscrew the transit brackets from one side of the product and set aside.

⑤



Check levelling feet have been raised, tilt product and insert handtruck. Restrain product to handtruck. We recommend using the corner posts to protect the product when using restraints.

⑥



Remove the two remaining transit brackets.

⑦



Tilt product onto handtruck and remove pallet. Move product to the installation location. Remove and discard corner posts.

## INSTALL ANTI-TIP BRACKET

①



Check for wall stud.

②



Measure the depth range of the alcove ensuring the minimum depth range has been met.

③



If required, install a spacer at the rear of the cavity to bring depth to 24" (610mm).

④



Measure the height from floor to the front overhang and mark on rear wall.

⑤



**For solid wall installs:**

Using the bracket as a guide, pre-drill four holes into the wall or spacer. Secure bracket using crosshead screws.

Install kit A

⑥



**For masonry wall installs:**

Using the bracket as a guide, pre-drill four holes into the wall. Hammer four masonry plugs into the wall until flush before securing the bracket using crosshead screws.

Install kit A

⑦



Ensure that the anti-tip bracket is installed correctly to prevent the possibility of the appliance tipping forward when the door is opened.

## HINGE SWAP (OPTIONAL)

①



Open the door and remove the door shelves. Unclip hinge covers from middle hinges. Loosen the hinge screws using the supplied Torx T25 driver. Slide the door out and place onto a protected surface.

Install kit D

②

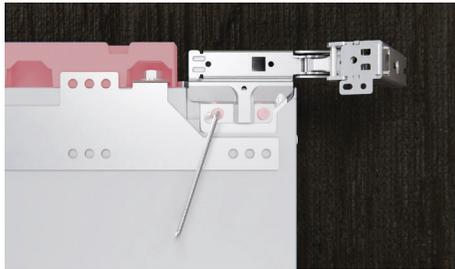

Carefully remove hinges from door and set aside.  
Remove both top covers and set aside.

Install kit D

③



Push on the edge of the outside plates, lift out and swap to the other side.

④



Use a flathead screwdriver to remove the inside plates. Move to the other side ensuring the rounded corners face the inside.

⑤



Check plates are positioned correctly.

⑥



Swap hinges as illustrated. Ensure base of hinge is parallel and tightened securely.  
Refit top covers.

⑦



Remove all 4 screws shown. Pull the trim out from hinge edge and flip 180°.

⑧



Ensure the 2x centre clips are on its marks and the side hooking clip on place.  
Locate trim by hooking clip then applying pressure to each centre clip position until clipping sound is heard.

## HINGE SWAP (OPTIONAL)

9



Partially refit the 4x hinge screws.

10



Swap alcove bracket with the hinge bracket. Secure using 3 screws at the top of the cabinet.

11



Slot the door back onto the screws and tighten using a torx key to tightly secure. Refit the door shelves. Repeat steps for lower door.

12

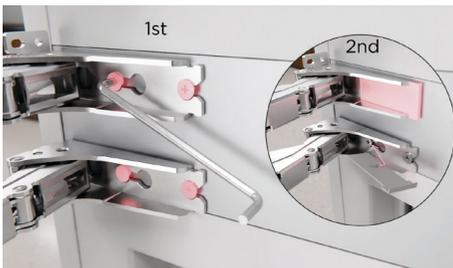

Refit both centre hinge covers by aligning to the hinge as shown, and sliding across to clip back hinge covers into position.

## JOIN PRODUCTS (MULTIPLE PRODUCT INSTALLS ONLY)

1



Secure the bracket at the front base using four screws.

Joiner kit A

2

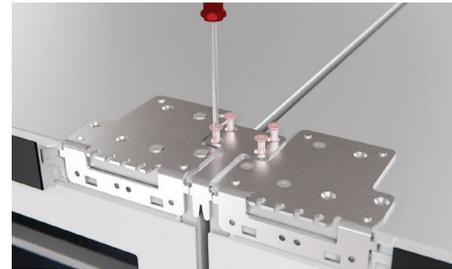

Secure the bracket at the front top using four screws.

Joiner kit B

3

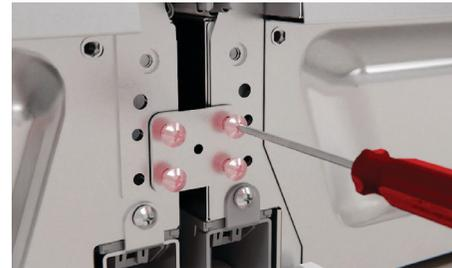

Secure the bracket at the rear base using four screws.

Joiner kit A

4



Secure the bracket at the rear top using four screws.

Joiner kit C

## JOIN PRODUCTS (MULTIPLE PRODUCT INSTALLS ONLY)

5



Repeat process for additional products.

## DEPTH GAUGES & SPACER

1



Clip both hinge spacers onto the product.

Ensure spacer A is fitted to the top of the product and spacer B is fitted to the bottom of the product, for right-hand hinge installations and vice versa for left-hand hinge installations.

Install kit B

2



Using the supplied crosshead screws, fit the depth gauges at the the top & bottom of the door as shown.

Install kits B & C

3

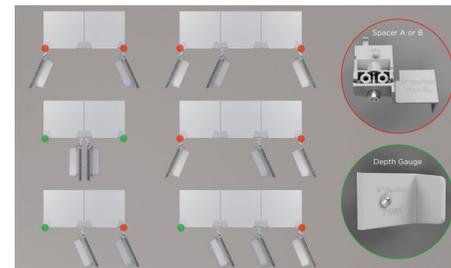

**Multiple product installs:**

Fit either the depth gauges or spacers at the top and bottom of the product based on your installation as shown.

## INSERT HINGE LIMITING PIN (OPTIONAL)

1



To limit the door opening to 90°, place the hinge limiting pin into the lower hinges on both doors.

Install kit H

## SERVICE CONNECTIONS

### OUTSIDE ALCOVE

①

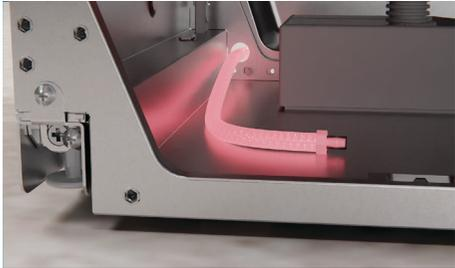

Route the hose from rear of product through to front corner.

②



Remove the cap from the valve before connecting the hose and tighten.

③



If required, wrap a thread around the hose and power cord to bring any slack inside the plinth and reduce the risk of them tangling behind the product.

④



Push product into alcove while pulling the hose and power cord. Ensure the gauges touch the alcove end, the hose doesn't kink and the power cord remains free and untangled.

⑤



Connect to tap and turn on. If water is running, check for leaks.  
Connect to outlet and turn power on.

## SERVICE CONNECTIONS

### INSIDE ALCOVE

①

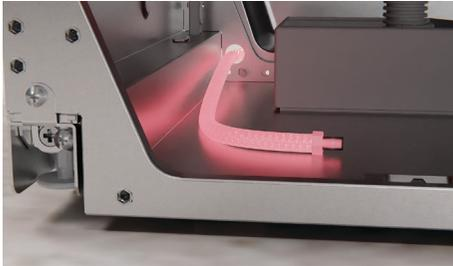

Route the hose from rear of product through to front corner.

②



Remove the cap from the valve before connecting the hose and tighten.

③



Connect to tap and turn on. If water is running, check for leaks.

④



If required, wrap a thread around the hose and power cord to bring any slack inside the plinth and reduce the risk of them tangling behind the product.

⑤



Connect to outlet and turn power on.

⑥



Push product into alcove. Push in until the gauges touch the alcove end. Ensure hose doesn't bend or kink and that the power cord is not trapped.

## ADJUST HEIGHT IN CAVITY

1

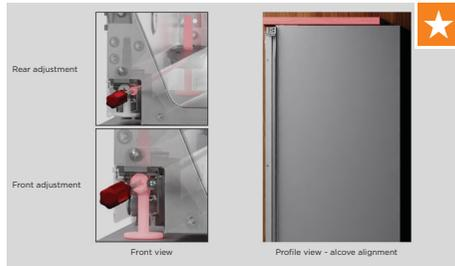

Turn the righthand screw to adjust the rear of the product followed by the lefthand screw to adjust the front. Turn clockwise to raise and anti-clockwise to lower.

Ensure feet engage with the floor and the upper bracket touches the alcove.

2



### Multiple product installs:

Beginning with the outside feet, turn the righthand screw to adjust the rear of the product followed by the lefthand screw to adjust the front. Once product is set in cavity, adjust the central feet.

Ensure feet engage with the floor and the upper bracket touches the alcove.

3

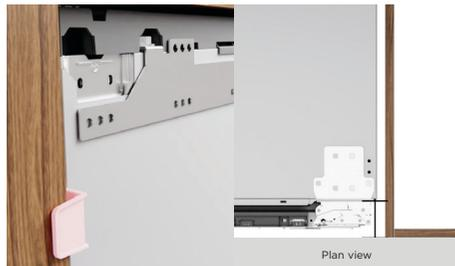

Ensure all depth gauges are flush to the front of the alcove.

### Where this is not possible:

Measure the distance between the chassis front and the alcove front as shown, ensuring it is 2 7/16" (62mm)\*.

4

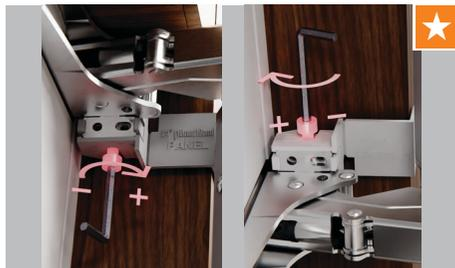

Open the door and use the supplied hex key to expand the spacers. Ensure no gaps are present.

Install kit D

\*assuming panel thickness of 3/4" 19mm.

## SECURE PRODUCT

1



Open the door and secure following the sequence shown. The longer screws should be used where shown in blue, and the smaller screws where shown in red. Ensure a gap between drill and product is maintained to avoid cosmetic damage.

Install kit B & E

2



Snap the ends off both spacers.

3



Clip covers onto spacers. Ensure cover A is fitted to spacer A and cover B to spacer B.

Install kit B

4



Unscrew the crosshead screws to remove depth gauges. Set aside.



## DOOR PANEL PREP

### CUSTOM PANEL

①



Recheck door panel size and specifications ensuring all bracket locations have been marked. Refer to page 14 for details. Alternately, the supplied door panel template can be used to mark bracket locations.

②



Remove both top covers. Set aside.

③



Remove both washers and nuts and set aside. Lift the panel brackets upwards to remove.

④



Align the centre door panel bracket to panel ensuring the 'V' in bracket is to sit on the centreline.

⑤

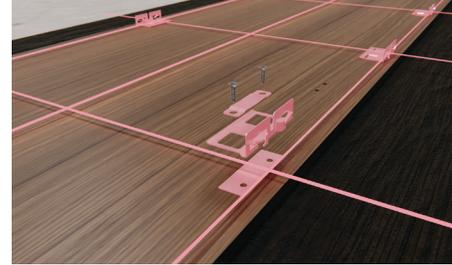

Align the side brackets to panel.

Install kit F

⑥



Using the screws supplied in the install kit, secure the door panel bracket using seven screws.

⑦



Secure the side brackets using two screws per bracket. Ensure side brackets are fitted tightly and the fasteners are secured straight.

⑧

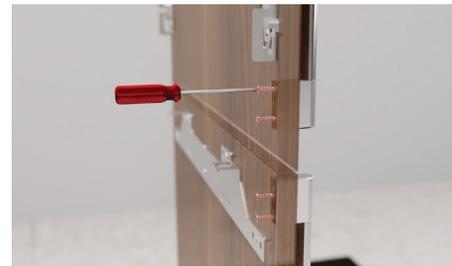

Secure the handle to the panels using 4xM5x25 hex screws per handle. Ensure handle fixings do not interfere with side brackets.

## DOOR PANEL PREP

### STAINLESS STEEL PANEL

①



Determine the panel orientation based on the hinge and handle position.  
Remove the four handle plugs from the door panel. Align and secure handle using M5x25 screws from handle kit. Repeat for lower door.

②



Remove both top covers using a powered driver. Set aside.

③



Remove both washers and nuts and set aside. Lift the panel brackets outwards to remove.

④



Align the centre bracket to pre-drilled holes on the panel.

⑤

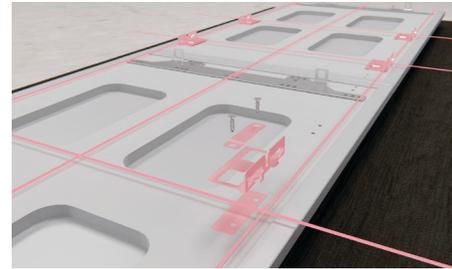

Remove all blue tape from the panel.  
Align the side brackets to the pre-drilled holes on the panel.

⑥

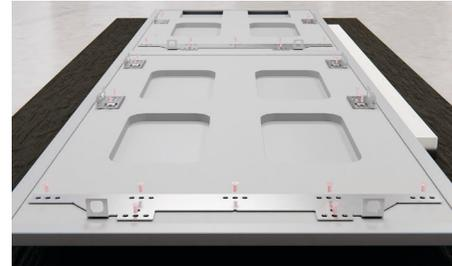

Using the screws supplied in the panel kit, secure the door panel bracket using seven screws.

⑦



Secure the side brackets using two screws per bracket from the supplied panel kit. Ensure side brackets are fitted tightly and the fasteners are secured straight.

## ALIGN DOOR PANEL

①



Ensure top mounting screws have been loosened and sit at their lowest position.

Install kit D

②



Locate the top of the door to the two mounting screws and lower.

③



We recommend loading the shelves in the door with 33lb (15kg) weights to ensure accurate panel gap widths.

④



Using a piece of tape, fit a tab on the door to assist in opening the door without disturbing panel settings.

## SECURE DOOR PANEL

①



Ensure side brackets are disengaged and the top mounting screws have been loosened. Rotate the mounting studs clockwise to lower the panel and anticlockwise to raise it.

②



Loosely tighten the side screws and the top M8 washers using the spanner and L key provided in the install kit.

Install kit D

③



Push panel side-to-side to adjust horizontally. Ensure panels are flush with front of cabinet.

④



Fit side screws to panel using the short crosshead tool provided in the install kit. For 90° door opening installs, the supplied crosshead key should be used on the hinge-side.

Tighten all side screws and the top M8 washer and nut to secure.

Install kit D

## SECURE DOOR PANEL

5

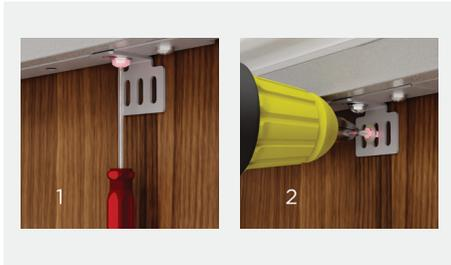

Open the door and loosen the lower bracket screw. Adjust the bracket until it rests against the door panel. Re-tighten the screw and fit an additional screw to secure to panel.

Install kit E

6



Fit the lower panel using the same process.

7



Recheck all gaps and any clashing.

## FIT TRIMS AND GRILLE

1

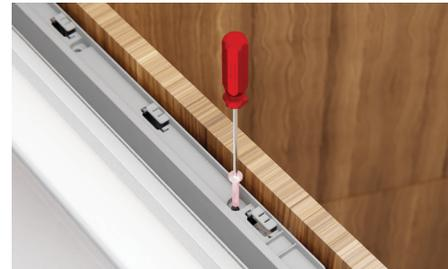

Fit the top cover using two screws. Ensure flat side faces out from the panel. Repeat for the lower door.

2



Locate the shorter door trim to the hinge-side of the product, and slide down to clip in place. If a gap is present, remove and readjust the side brackets. Repeat for lower door.

3



Locate the longer door trim to the non-hinge-side of the product and slide down to clip in place. If a gap is present, remove and readjust the side brackets. Ensure trim does not protrude above the top cover. Repeat for lower door.

4



Fit the top trim on the lower door.

## FIT TRIMS AND GRILLE

5



### Hinge swap installs only:

Swap the bottom hinge and non-hinge trims on the grille.

6



Fit the top UI trim taking into account the hinge location.

Install kit H

7



Open the cover and align the grille to the product. Slot into place starting with the base of the grille. Hand tighten the top left screw first, followed by the top right screw. Fit the remaining five screws on the grille to secure.

## CENTRE TRIM INSTALL (MULTIPLE PRODUCT INSTALLS ONLY)

1



Locate trim between products. Lower trim before pushing in to ensure bottom connector bracket clears the grille. Slide trim up until it slots into the top bracket.

2

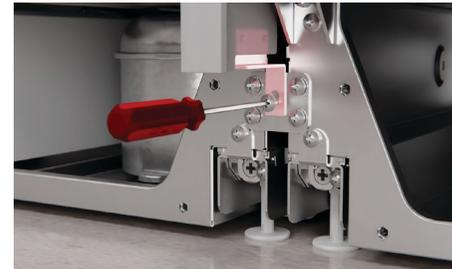

Ensure top of trim touches alcove before securing using the supplied fastener.

Joiner kit A

## TOE KICK PANEL PREP

①



Recheck toe kick panel size and specifications. Refer to page 13 for details.

②



● Screw locations

Measure distance from floor to bottom of grille to determine the position of the toe kick mounting plate.  
Secure supplied toe kick mounting plate in trim kit to the toe kick panel.

Install kit E

## SECURE TOE KICK

①

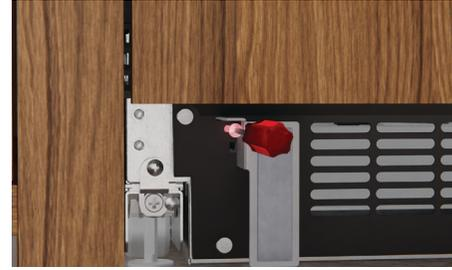

Loosen the screws on both toe kick depth adjustment brackets.

②



Slide both depth adjustment brackets all the way forward and slightly tighten the screws.

③



Attach the toe kick to the depth adjustment brackets. The magnets should auto-locate.

④

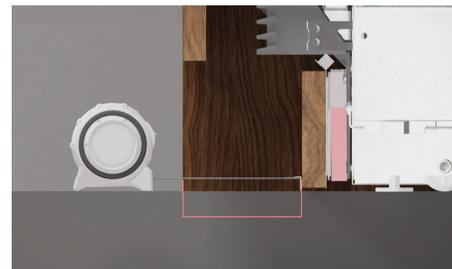

Push the toe kick back to the desired depth before removing. If toe kick depth is less than 3 9/16" (90mm), attach the additional foam block.

Hand tighten the depth adjustment screws and refit the panel.

## SECURE TOE KICK

5



Measure the distance between the bottom of the door and the base of the door panel. Cut the flow divider to length.

Install kit D

6



Align flow divider to the screw at the bottom of the door and slot into place. Secure to the door panel using the provided screws.

7



Cut the seal to length and clip onto the front of the flow divider. Ensure tabs on the seal and flow divider align.

8



On the UI, press and hold  to exit installer mode.

## WI-FI SET UP

Your appliance may be connected to your home wireless network and operated remotely using the app.

- Ensure your home Wi-Fi network is turned on.
- You will be given step by step guidance on both your appliance and mobile device.
- It may take up to 10 minutes to connect your appliance.

**On your mobile device:**

- 1 Download the app from [www.fisherpaykel.com/connect](http://www.fisherpaykel.com/connect)
- 2 Register and create an account.
- 3 Add your appliance and set up the Wi-Fi connection.

1



Press  to display the menu.

2

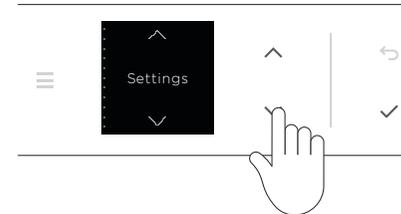

Press  or  to scroll through the list and select **SETTINGS**. Press  to confirm.

3

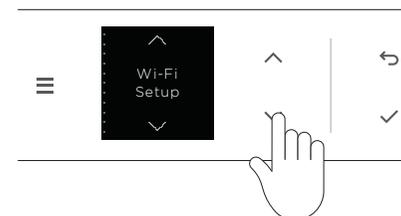

Press  or  to scroll through the list and select **WI-FI SETUP**. Press  to confirm.

4

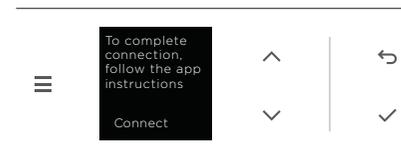

Open the **FISHER & PAYKEL** app on your mobile device. Follow the onscreen guidance.

## FLUSH WATER THROUGH THE WATER DISPENSER

①



Ensure power and water connections have been turned on.

②



Press the water dispenser pad and dispense a total of 2 Gallons of water. A harmless carbon residue may be dispensed with the water during this process.

③



When dispensing for long durations, a time out period may occur where an alarm will sound. Please wait 4 minutes before dispensing again.

## FLUSH WATER THROUGH THE ICE MAKER

①



Ensure power and water connections have been turned on.

②

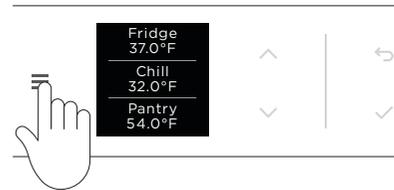

Press ≡ to display the menu.

③



Press ▼ or ▲ to scroll through the list and select ICE.  
Press ✓ to turn ice maker on.

④



The flushing process will be complete after the first full bin of ice is produced. We recommend discarding this batch of ice as it may appear slightly discoloured and contain a harmless carbon residue.



## REPLACING WATER FILTER

①



Push grille flap to access filter. Pull tool outwards to remove.

②

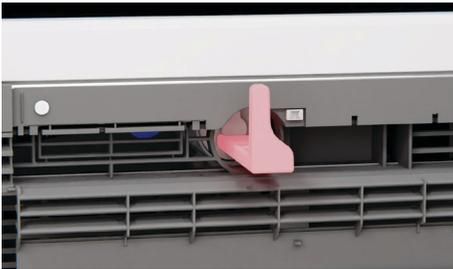

Using the filter tool, rotate filter 90° anti-clockwise to unlock and remove.

③

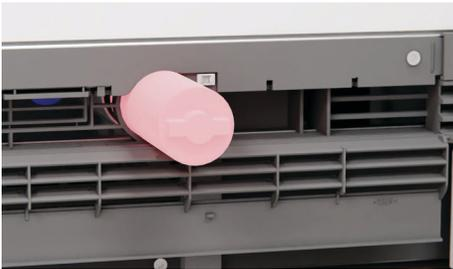

Remove packaging. Ensure filter handle is positioned horizontally and push all the way in. Rotate clockwise to lock into place.

④



Slot tool into place and push to close the grille flap.

## INSTALLER CHECKLIST

Installer mode has been exited

All panel gaps and any potential clashing points have been checked

Levelling feet have been adjusted and engaged



Hinge limiting pins have been fitted if required

All trims have been secured at all attachment points

All covers are in place

Product is robustly attached to cabinetry

If water is turned on, purge before first use

### Complete and keep for safe reference:

Model \_\_\_\_\_

Serial no. \_\_\_\_\_

Purchase date \_\_\_\_\_

Purchaser \_\_\_\_\_

Dealer address \_\_\_\_\_

Installer's name \_\_\_\_\_

Installer's signature \_\_\_\_\_

Installation company \_\_\_\_\_

Installation date \_\_\_\_\_

## SAFE PRODUCT REMOVAL

①



Empty contents.

②



Remove the flow divider and panel bracket before removing all door panel side screws and the M8 washer and nut. Lift panel up and out to remove.

③



Reverse the installation process to remove from alcove. Ensure doors are taped shut and safe handling practices are observed.

**FISHERPAYKEL.COM**

© Fisher & Paykel Appliances 2022. All rights reserved.

The models shown in this guide may not be available in all markets  
and are subject to change at any time.

The product specifications in this guide apply to the specific products and  
models described at the date of issue. Under our policy of continuous product  
improvement, these specifications may change at any time.

For current details about model and specification availability in your country,  
please go to our website or contact your local Fisher & Paykel dealer.

**867869A 09.22**