

# FISHER & PAYKEL

## COMBINATION STEAM OVEN

---

### MINIMAL

OS24NMTDB1, OS24NMTDG1, OS24NMLB1 & OS24NMLG1

### CONTEMPORARY

OS24NDTDX1, OS24NDLX1

INSTALLATION GUIDE

US CA

## IMPORTANT SAFETY INSTRUCTIONS

### ⚠ WARNING!



#### Electric Shock Hazard

Failure to follow this advice may result in electric shock or death.

- Before carrying out any work on the electrical section of the appliance, it must be disconnected from the mains electricity supply.
- Connection to a good ground wiring system is absolutely essential and mandatory.
- Alterations to the domestic wiring system must only be made by a qualified electrician

### ⚠ WARNING!



#### Fire Hazard

Failure to follow this advice may result in overheating, burning, and injury.

- Do not use adapters, reducers, or branching devices to connect this appliance to the mains power supply.

### ⚠ WARNING!



#### Cut Hazard

Failure to use caution could result in injury.

- Take care: some edges are sharp.

## READ AND SAVE THIS GUIDE

### WARNING!

To avoid hazard, follow these instructions carefully before installing or using this appliance.

- Please make this information available to the person installing the appliance—doing so could reduce your installation costs.
- Save these instructions for the local inspectors use.
- This oven is to be installed and connected to the electricity supply only by an authorized person.
- If the installation requires alterations to the domestic electrical system, call a qualified electrician. The electrician should also check that the socket cable section is suitable for the electricity drawn by the oven.
- The oven must be grounded.
- Installation must comply with your local building and electricity regulations.
- This appliance must be installed and connected to the mains power supply only by a suitably qualified person according to these installation instructions and in compliance with any applicable local building and electricity regulations. Failure to install the appliance correctly could invalidate any warranty or liability claims.
- If the power supply cable is damaged, it must be replaced by the manufacturer, its service agent or similarly qualified person in order to avoid a hazard.
- A circuit breaker is recommended.
- Do not use adaptors, reducers or branching devices to connect the oven to the mains electricity supply, as they can cause overheating and burning.
- The appliance must not be installed behind a decorative door in order to avoid overheating.
- The manufacturer does not accept any responsibility for damage resulting from incorrect installation.

#### Electrical requirements

- Connect oven with copper wire only.
- Do not cut the conduit.
- A U.L. listed conduit connector must be provided at the junction box.
- Do not ground to a gas pipe.
- Do not have a fuse in the grounding or neutral circuit.
- Fuse both sides of the line.
- A time delay fuse or circuit breaker is recommended. If using a time delay fuse, then fuse both sides of the line.
- Flexible armored cable from the appliance should be connected directly to the junction box.
- Connect directly to the fused disconnect (or circuit breaker box) through flexible, armored or non-metallic sheathed, copper cable (with grounding wire).
- If codes permit and a separate grounding wire is used, it is recommended that a qualified electrician determine that the grounding path and wire gauge are in accordance with local codes.

## PRIOR TO INSTALLATION

Ensure that:

- The oven cavity is square and level based on the required dimensions
- The installation will comply with all clearance requirements and applicable standards and regulations
- The isolating switch will be easily accessible to the customer with the oven installed
- The electrician provides sufficient free length of power supply cable to reach from the bottom rear of the cavity to at least 5ft (1.5m) in front of the bottom edge of the opening
- The cable may enter the cavity from the side, top or bottom, but top entry must be at the rear of the cavity
- The oven connection socket is outside the cavity if the oven is flush to the rear wall
- The oven will rest on a surface that can support its weight
- The height from the floor suits the customer
- You consult local building authorities and by-laws if in doubt regarding installation

### IMPORTANT!

**Some environmental factors and cooking habits can cause condensation in and around the oven during use. To protect surrounding cabinetry from possible damage caused by frequent or excessive condensation, we recommend moisture-proofing the oven cavity.**

## AFTER INSTALLATION

Ensure that:

- The oven door can open fully without obstruction
- The oven is not sealed into the cabinetry with silicone or glue. This makes future servicing difficult. Fisher & Paykel will not cover the costs of removing the oven, or of damage caused by this removal
- The power supply cable does not touch any hot metal parts
- The isolating switch is easily accessible to the customer with the oven installed
- You complete the 'Installer checklist' at the end of the installation
- There is enough clearance for opening and closing operation of the moving control panel.

If, after following the guidance given, correct performance cannot be achieved, please contact your nearest Fisher & Paykel trained and supported service technician, Customer Care, or contact us through our website [fisherpaykel.com](http://fisherpaykel.com)

## INSTALLATION MILESTONES

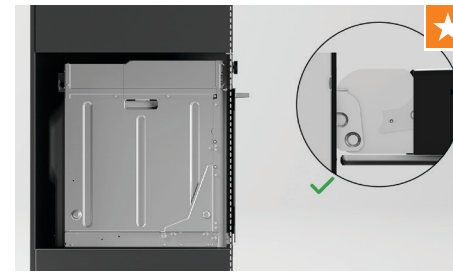

Milestone indicator

These milestones represent areas throughout that are pivotal to an optimal installation outcome. These steps require additional installer attention and should be quality checked once completed.

### MILESTONE LINKS



Ensure both hinges are fully locked before shutting the door.



Align oven with surrounding cabinetry and appliances.

## COMPONENTS

### PARTS

Supplied



Screws (2)

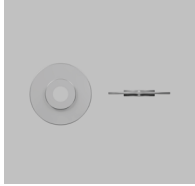

Metal side shelves  
fixing nut (2)

### TOOLS

Not supplied



Powered driver

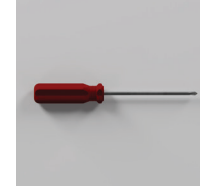

Cross-head  
screwdriver

# PRODUCT DIMENSIONS

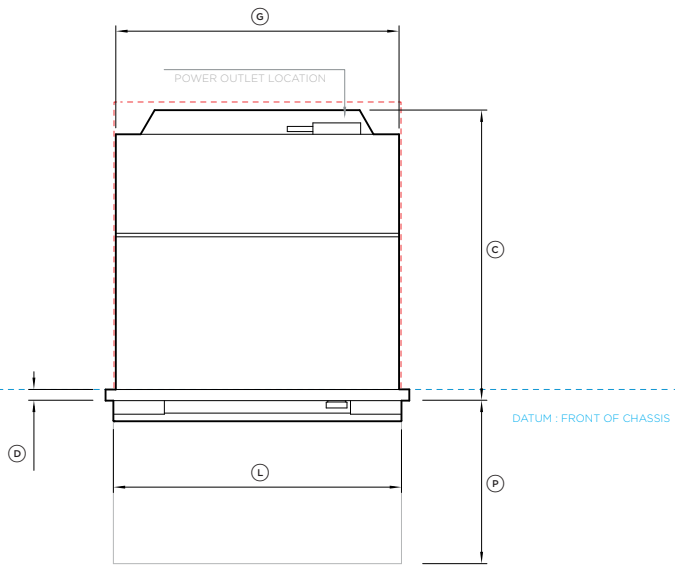

PLAN VIEW

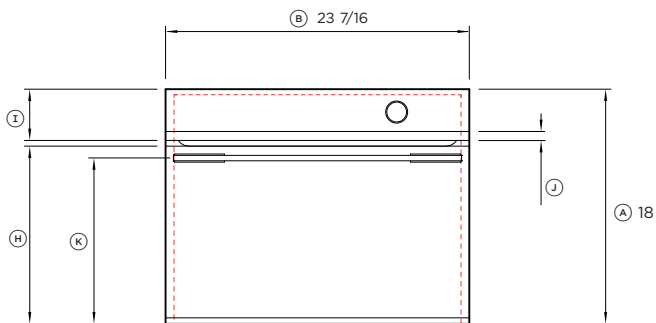

FRONT VIEW

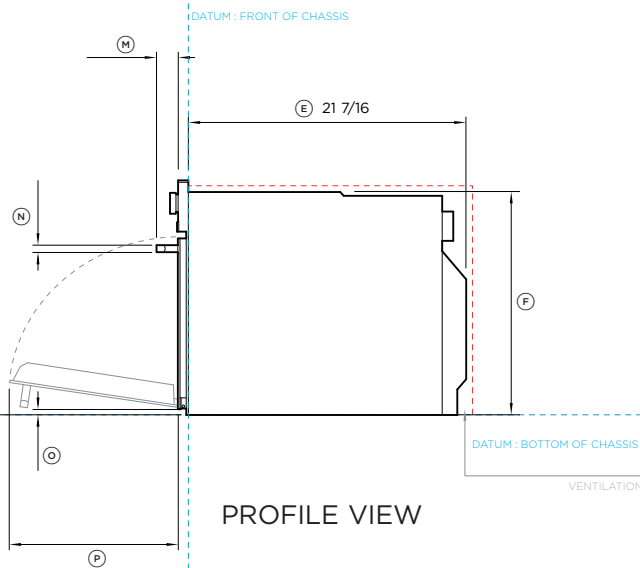

PROFILE VIEW

Product Dimensions	inch	mm
Ⓐ Overall height of oven	18	458
Ⓑ Overall width of oven	23 7/16	596
Ⓒ Overall depth of oven (excludes handle and front metal trim)	22 1/4	565
Ⓓ Depth of oven frame, control panel and door (excludes handle and front trim)	13/16	20
Ⓔ Depth of chassis (includes terminal block)	21 7/16	545
Ⓕ Height of chassis	17 1/8	435
Ⓖ Width of chassis	21 7/8	556
Ⓜ Height from bottom datum to top of oven door	13 11/16	347
Ⓨ Height of control panel	3 15/16	100
Ⓩ Height of metal cap on control panel	13/16	20
Ⓚ Height from bottom datum to centerline of handle	12 3/4	324
Ⓛ Width of handle	22 1/4	565
Ⓝ Depth of handle (measured from front of door)	1 5/8	42
Ⓞ Thickness of handle	5/8	16
Ⓟ Distance from bottom datum to bottom of door glass	1/2	12
Ⓟ Depth of door (open) (measured from front of door)	12 5/8	320

Minimum Clearances	inch	mm
Minimum inside height of cavity	17 5/16	440
Minimum inside width of cavity	22 1/16	560
Minimum inside depth of cavity	21 5/8	550
Overall height of cabinetry (cavity around front frame)	18 1/8	460
Overall width of cabinetry (cavity around front frame)	23 5/8	600
Rear ventilation air vent depth*	2	50
Rear ventilation air vent width*	22 1/16	560

\*A rear ventilation air vent totalling 44in<sup>2</sup> (280cm<sup>2</sup>) is required. The air vent must be located at the rear of the cabinet, it can be positioned at the base, sides, back or top of the cavity.

IMPORTANT NOTE: Throughout this guide, dimensions may vary by ±2mm (1/16")

INDICATES PRODUCT DATUM -----  
 INDICATES CABINETRY CLEARANCES - - - - -

## CABINETY DIMENSIONS

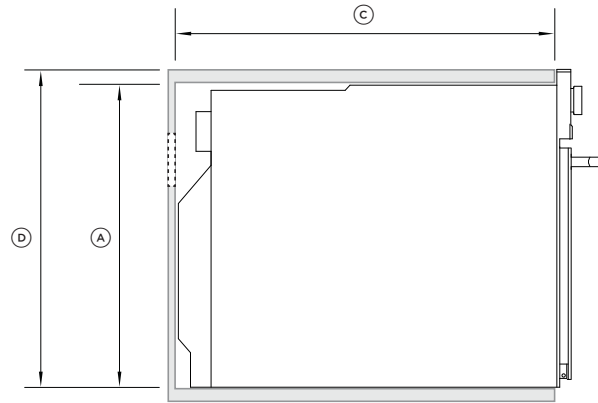

PROFILE

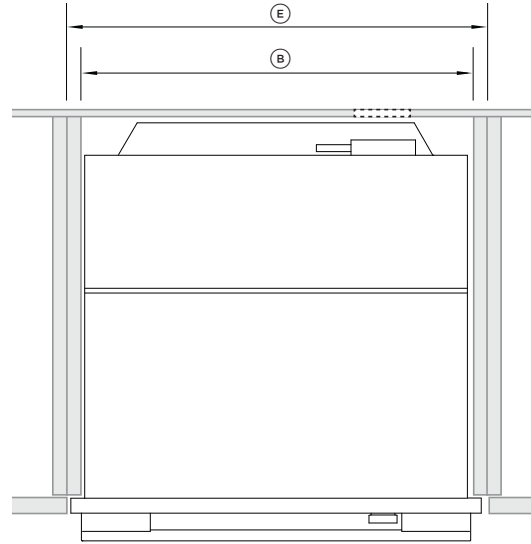

PLAN

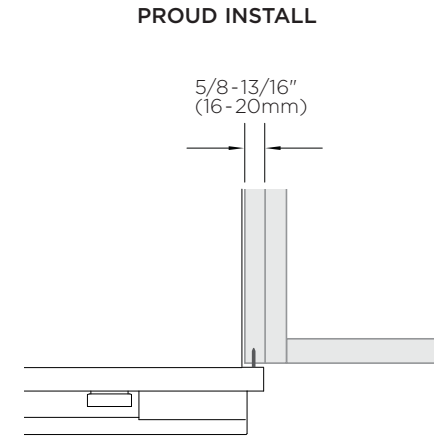

PROUD INSTALL

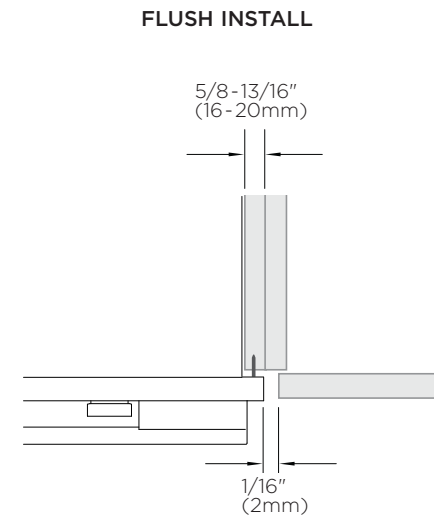

FLUSH INSTALL

CABINETY DIMENSIONS	OS24N	
	INCHES	MM
Ⓐ Minimum inside height of cavity	17 5/16	440
Ⓑ Minimum inside width of cavity	22 1/16	560
Ⓒ Minimum inside depth of cavity	21 5/8	550
Ⓓ Overall height of cabinetry (cavity around front frame)	18 1/8	460
Ⓔ Overall width of cabinetry (cavity around front frame)	23 5/8	600

If installing a cooktop above the oven, ensure adequate clearance is provided as per the cooktop manufacturer's instructions.

Ensure a 3/16" (5mm) minimum clearance is maintained between the top of the oven chassis and the cabinetry. Ensure the oven is not bearing any weight from cabinetry or products installed above.

## CHECK CAVITY

①

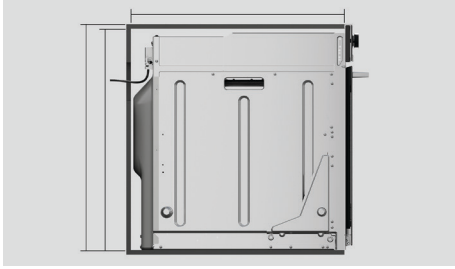

Measure cavity dimensions. Ensure all minimum specifications have been met. Refer to page 6.

②

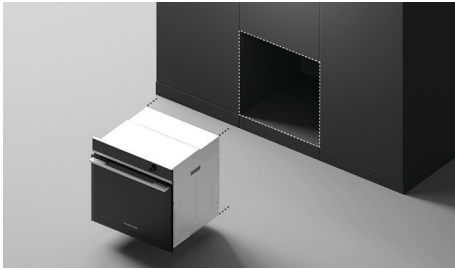

For dark cabinetry, ensure clashing has been considered and installed.

③

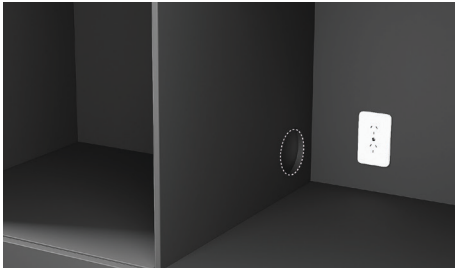

Ensure service access complies with local requirements. Refer to page 9 for details.

④

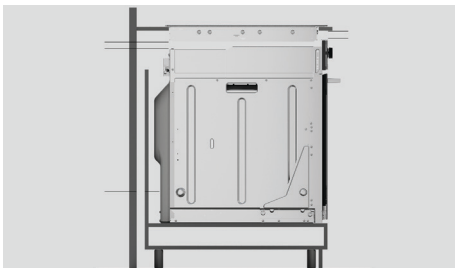

Ensure any cooktop ventilation requirements have been considered.

## UNPACK PRODUCT

- Do not lift or move the product using the handle.
- Keep all packing materials until the unit has been inspected.
- Inspect the product to ensure there is no shipping damage. If any damage is detected contact the dealer or retailer you brought the product from to report the damage.
- Fisher & Paykel is not responsible for shipping damage.

①



Cut all straps and remove the carton top cap.

②



Lift the carton sleeve and remove any transit packaging.

③



Set aside any accessories.

## UNPACK PRODUCT

④



Remove all control panel packaging. The control panel can be moved manually as needed. Take care when handling.

⑤



Dispose responsibly.

## REMOVE DOOR

①

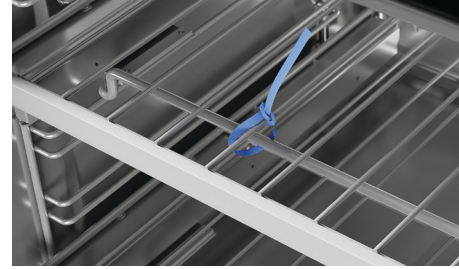

Open the door and remove all cable ties and packaging holding the oven shelves in place.

②



Grip the shelves at the front, making sure to hold the wire shelf and frame together. Lift upwards and pull out from the oven.

③



Locate the hinge locks on either side of the door. Push the locks upwards to release.

④

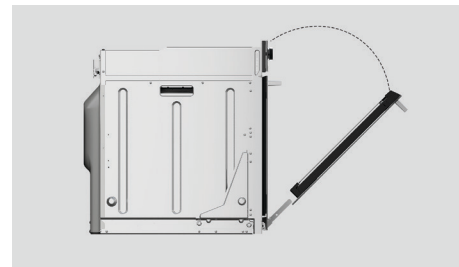

Holding the door on both sides, partially close the door and carefully pull the door away from the hinges.



## CONNECT POWER

- This oven must be connected to the mains power supply only by a suitably qualified person.
- This oven must be earthed.

Before connecting the oven to the mains power supply, check that:

the domestic wiring system is suitable for the power drawn by the oven (as specified on the rating plate)

the voltage corresponds to the value given on the rating plate.



### OS24N MODELS

VOLTAGE	MAX. CURRENT DRAW	MAX LOAD
208 V	16.5 A	3.4 kW
240 V	19 A	4.5 kW

### THREE WIRE CONNECTION

①

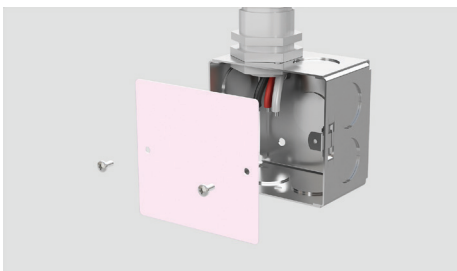

Disconnect the power supply and remove the junction box cover.

②



Connect the oven cable to the junction box through the U.L.-listed conduit connector.

### THREE WIRE CONNECTION

③

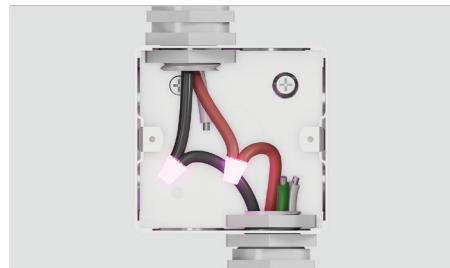

Connect the two black wires together with twist-on connectors and the two red wires together with twist-on connectors.

④



Connect electrical connection according to local codes and ordinances.

If local codes DO NOT PERMIT connecting the cabinet-grounding conductor to the neutral (white) wire in junction box.

①

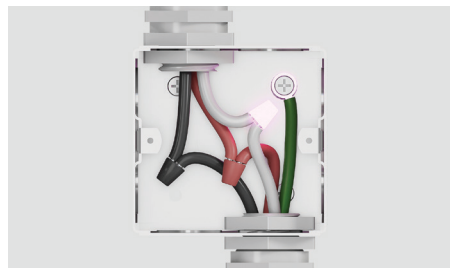

Separate the factory-taped green and white oven cable wires. If junction box is grounded, connect the green wire to the metal junction box with a screw before connecting the white oven cable wire to the neutral (white) wire in junction box.

②

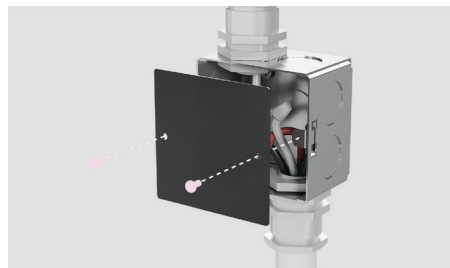

Replace the junction box cover.

## CONNECT POWER

### THREE WIRE CONNECTION

If local codes permit connecting the cabinet-grounding conductor to the neutral (white) wire in junction box.

①

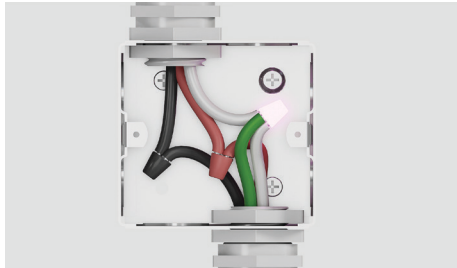

Connect the factory-taped green and white oven wires to the neutral (white) wire in the junction box.

②

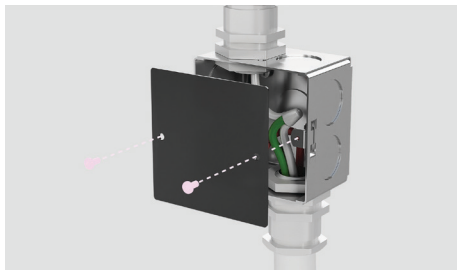

Replace the junction box cover.

### FOUR WIRE CONNECTION

①

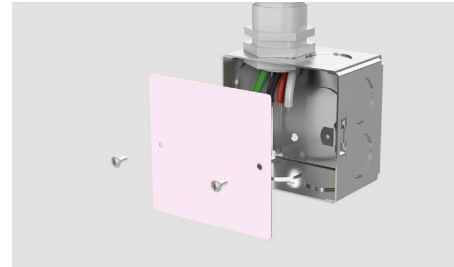

Disconnect the power supply and remove the junction box cover.

②

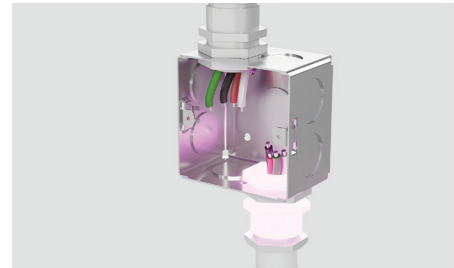

Connect the oven cable to the junction box through the U.L. - listed conduit connector.

③

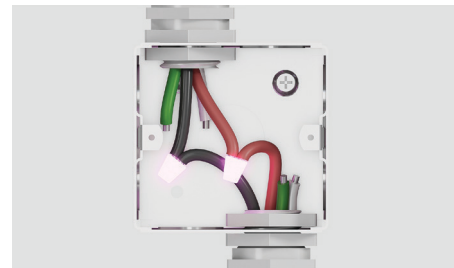

Connect the two black wires together with twist-on connectors and the two red wires together with twist-on connectors.

④



Connect electrical connection according to local codes and ordinances.

## CONNECT POWER

### FOUR WIRE CONNECTION

5

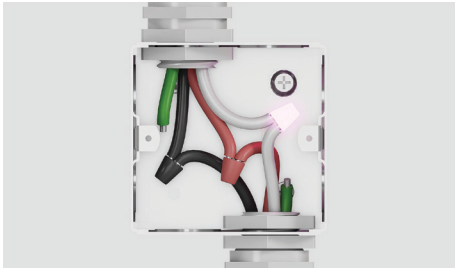

Separate the green and white oven cable wires. Connect the white oven cable wire to the neutral (white) wire in junction box.

6

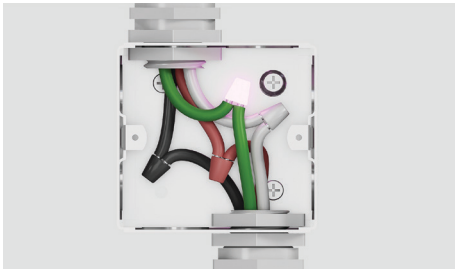

Connect the green grounding oven cable wire to the (green) grounding wire in the junction box. Do not connect the green grounding wire to the neutral (white) wire in junction box.

7

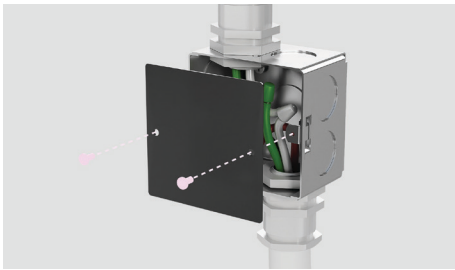

Replace the junction box cover.

## POSITION OVEN INTO CAVITY

1



### Some models only\*:

For dark cabinetry, the supplied trim can be used to enhance clashing finish.

To install, remove the trim adhesive and press to secure to cavity.

2



Ensure control panel is closed. Lift product into cavity taking care not to lift from the control panel.

\*To purchase cabinetry trim as an optional accessory, visit [fisherpaykel.com](http://fisherpaykel.com)

## REFIT DOOR

①

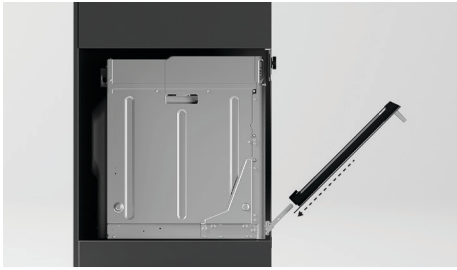

Holding the door on both sides, carefully lift door back onto the hinges.

②



Open the door fully and push each locking lever down and lock into place.

③

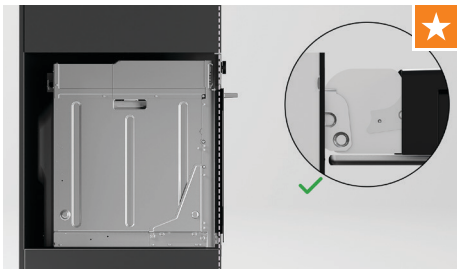

Ensure both hinges are fully locked before shutting the door.

## ALIGN AND SECURE

①



Align oven with surrounding cabinetry and appliances.

②



Using the product as a guide, pre-drill 2 x 3mm pilot holes.

③



Secure oven to cavity using the 2 x #7x13 pan head screws provided.

## REFIT SHELVES

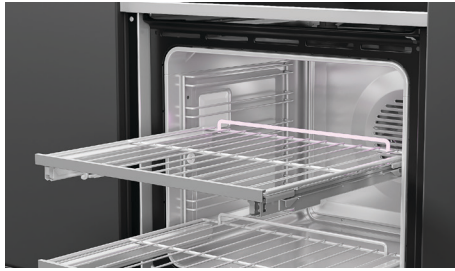

### Sliding shelves

Place shelves back into the oven at the desired level.

Ensure shelves are level and correctly positioned with the guard rail at the back.

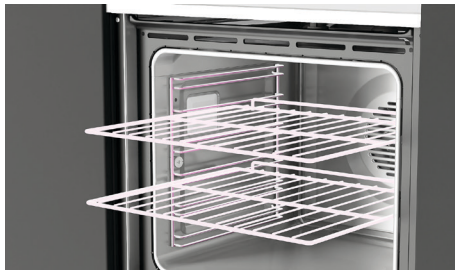

### Wire shelves

Slide shelves into the cavity.



### Clip on sliding shelf supports

Ensure the slides are positioned the correct way around, with the triangular tab at the front.

Fit the top clips over the side rack. The front clip should be fitted as close to the front of the side rack as possible. Make sure the rear clip has engaged.

Click the bottom clips into place.

## TEST OVEN



Follow the guidance on screen to ensure oven turns on and heats correctly.

Refer to your User Guide for more information.

## INSTALLER CHECKLIST

---

### TO BE COMPLETED BY THE INSTALLER

- Ensure the oven is level and securely fitted to the cabinetry.
- Open the oven door slowly until it is fully open and check there is adequate clearance between the bottom of the door and the lower trim.  
This is to ensure correct air circulation. Should the lower trim become damaged, straighten the trim and ensure the oven door opens fully without obstruction.
- Ensure all internal packaging (including the circular yellow packing retainers holding the accessory box in place) is removed.
- Ensure all oven vents and openings are clear and free of any obstruction or damage.  
**Failure to make sure all oven vents are clear may result in poor product performance.**
- Ensure the isolating switch is accessible by the customer.

---

Complete and keep for safe reference:

Model \_\_\_\_\_

Serial No. \_\_\_\_\_

Purchase Date \_\_\_\_\_

Purchaser \_\_\_\_\_

Dealer Address \_\_\_\_\_

Installer's Name \_\_\_\_\_

Installer's Signature \_\_\_\_\_

Installation Company \_\_\_\_\_

Installation Date \_\_\_\_\_

**FISHERPAYKEL.COM**

© Fisher & Paykel Appliances 2023. All rights reserved.

The models shown in this guide may not be available in all markets  
and are subject to change at any time.

The product specifications in this guide apply to the specific products and  
models described at the date of issue. Under our policy of continuous product  
improvement, these specifications may change at any time.

For current details about model and specification availability in your country,  
please go to our website or contact your local Fisher & Paykel dealer.

**90002693A 09.23**