

# 24" Bar Handle Dishwasher

800 Series – White SHX78CM2N

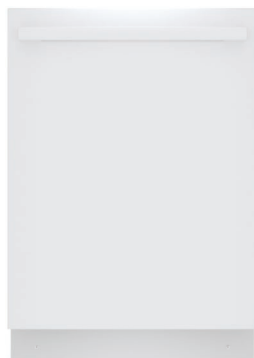

**BOSCH**  
Invented for life



**SHX78CM2N**  
White

Also available in:

- Stainless Steel SHX78CM5N
- Black SHX78CM6N
- Black SHX78CM4N
- Stainless

**PowerControl™ spray arm targets your dirtiest dishes with a deeper clean, no matter where you load them on the bottom rack.**

## Features & Benefits

Patented CrystalDry™ technology transforms moisture into heat to get dishes, including plastics, 60% drier.\*

The Flexible 3rd Rack with fold down sides adds 30% more\* loading area, perfect for utensils and ramekins.

Enhance your cleaning experience with Wi-Fi enabled Home Connect®. Access additional wash cycles and options or choose the right one for your needs using Smart Cycle.

So quiet at 42 dBA, InfoLight® shines on the floor so you know the dishwasher is running.

General Properties	
Number of wash cycles	5 + 3 additional in Home Connect®
Number of options	4 + 2 additional in Home Connect®
dBA	42
Wash system	PrecisionWash® with PowerControl™
Drying system	CrystalDry™
Third rack	Flexible 3rd Rack
Rack adjustability	Rackmatic®
Tub material	Stainless Steel
Control type	Touch Controls
Concealed water heating element	Yes
Leak protection system	24/7 AquaStop®
Home Connect® (WiFi enabled)	Yes
NSF®-certified** sanitize option	Yes
Water softener	No
Five-level wash	Yes
Child Lock button suspension	No
Anti-Fingerprint Finish	N/A
Special features	CrystalDry™ Option, InfoLight®
Efficiency	
Water usage per cycle	3.2 gal
ENERGY STAR® certified	Yes
Total annual energy consumption	240 kWh
Capacity	
Number of place settings	16

## Home Connect



\* Based on aggregate average drying performance of Bosch Dishwashers with CrystalDry™ on combined household load including plastics, glass, steel, and porcelain as compared to Bosch Dishwashers with PureDry®. Drying performance may vary by dish type.

\*Compared to a Bosch dishwasher with 2 racks.

\*\*Certification to NSF/ANSI Standard 184 for residential dishwashers.

Technical Details	
Watts	1440 W
Current	12 Amps
Volts	120 V
Frequency	60 Hz
Power cord full length	67"
Power cord install length from edge of unit when facing the door	Left – 45" Right – 56"
Minimum water pressure	14 lb/sin
Length outlet hose	78 3/4"
Dimensions & Weight	
Overall appliance dimensions (HxWxD)	33 7/8" x 23 9/16" x 23 3/4"
Required cutout size (HxWxD)	33 7/8" x 24" x 24"
Adjustable feet	Yes
Net weight	96 lbs
Accessories—Optional	
Junction Box	SMZPCJB1UC
Junction Box + Supply Hose Kit	SMZ3IN1UC
Supply Hose Kit with Elbow	SMZSH1ABUC
Drain Hose Extension Kit	SGZ1010UC
Dishwasher Accessory Kit	SMZ5000
Anti-Tarnish Silverware Cassette	SMZ5002UC
Edge Protector + Power Cord Clip Install Kit	SMZEPCC1UC

**Accessories:** To purchase Bosch accessories, cleaners & parts please visit [www.bosch-home.com/us/store](http://www.bosch-home.com/us/store) or call 1-800-944-2904 (Mon to Fri 5 am to 6 pm PST, Sat 6 am to 3 pm PST).

**Notes:** All height, width and depth dimensions are shown in inches. BSH reserves the absolute and unrestricted right to change product materials and specifications, at any time, without notice. Consult the product's installation instructions for final dimensional data and other details prior to making cutout.

**Warranties:** Please see Use & Care manual or Bosch website for statement of limited warranty.

**For more information on our entire line of products, go to [www.bosch-home.com/us](http://www.bosch-home.com/us) or call 1-800-944-2904**

© BSH Home Appliances Corporation. All rights reserved. Bosch is a registered trademark of Robert Bosch GmbH.

# 24" Bar Handle Dishwasher

800 Series – White SHX78CM2N



## Installation Details

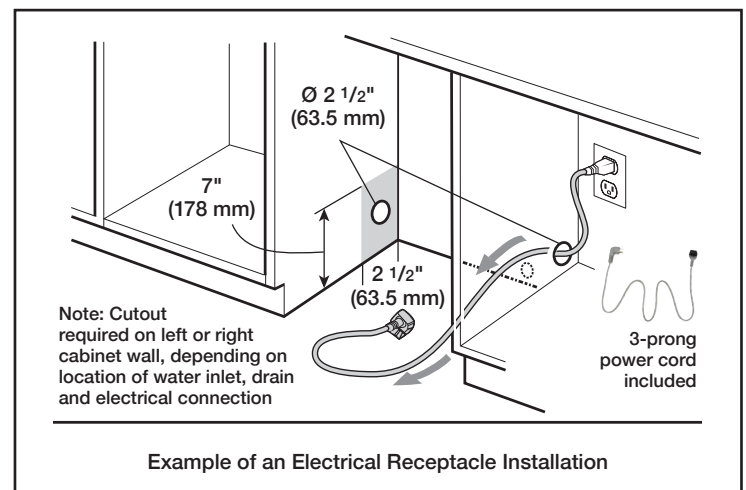
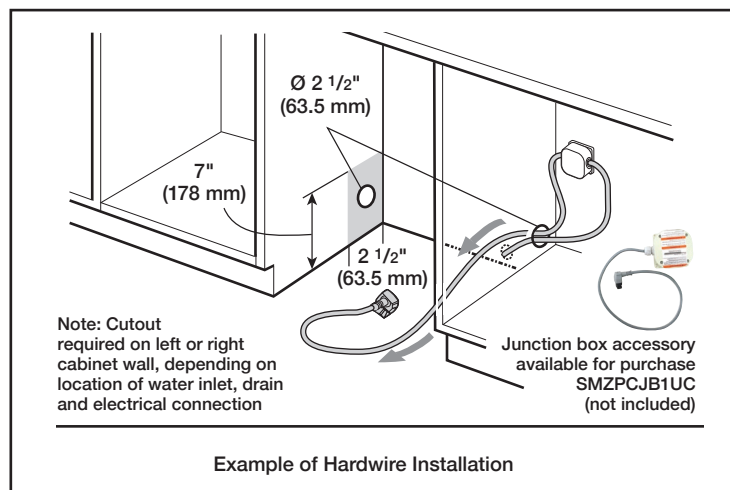
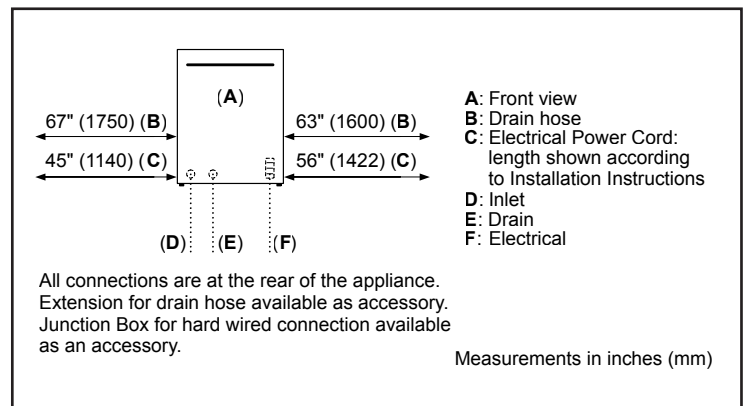
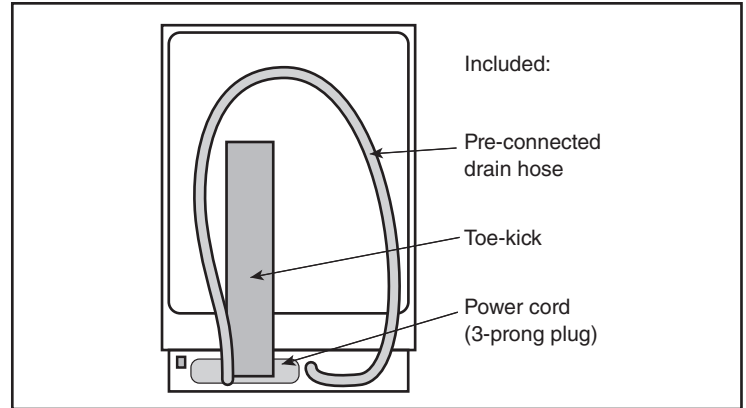
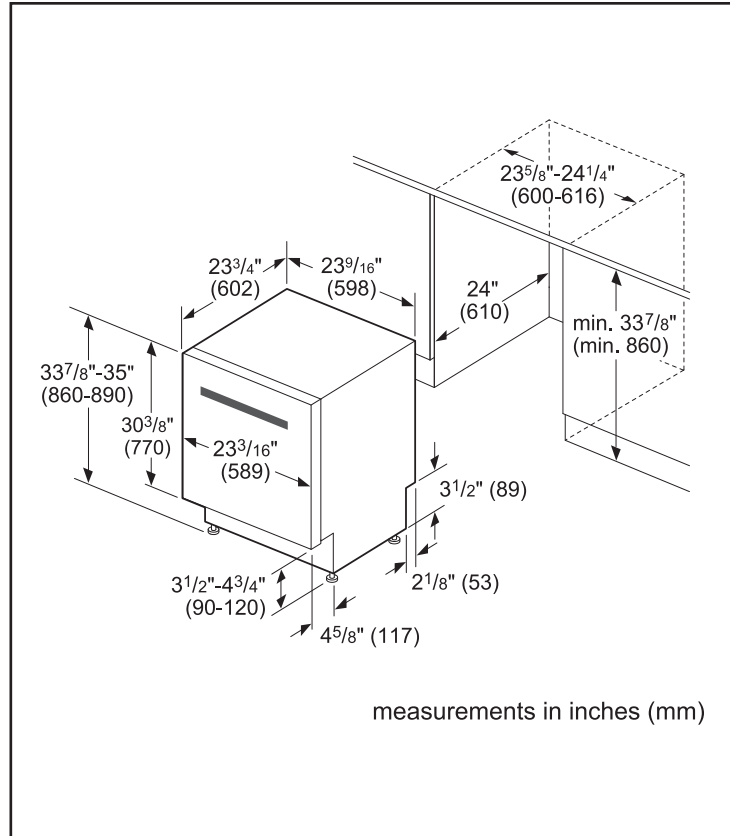

**Accessories:** To purchase Bosch accessories, cleaners & parts please visit [www.bosch-home.com/us/store](http://www.bosch-home.com/us/store) or call 1-800-944-2904 (Mon to Fri 5 am to 6 pm PST, Sat 6 am to 3 pm PST).

**Notes:** All height, width and depth dimensions are shown in inches. BSH reserves the absolute and unrestricted right to change product materials and specifications, at any time, without notice. Consult the product's installation instructions for final dimensional data and other details prior to making cutout.

**Warranties:** Please see Use & Care manual or Bosch website for statement of limited warranty.

**For more information on our entire line of products, go to [www.bosch-home.com/us](http://www.bosch-home.com/us) or call 1-800-944-2904**

© BSH Home Appliances Corporation. All rights reserved. Bosch is a registered trademark of Robert Bosch GmbH.

# 24" Bar Handle Dishwasher

800 Series – White SHX78CM2N



**BOSCH**

Invented for life



## Installation Details

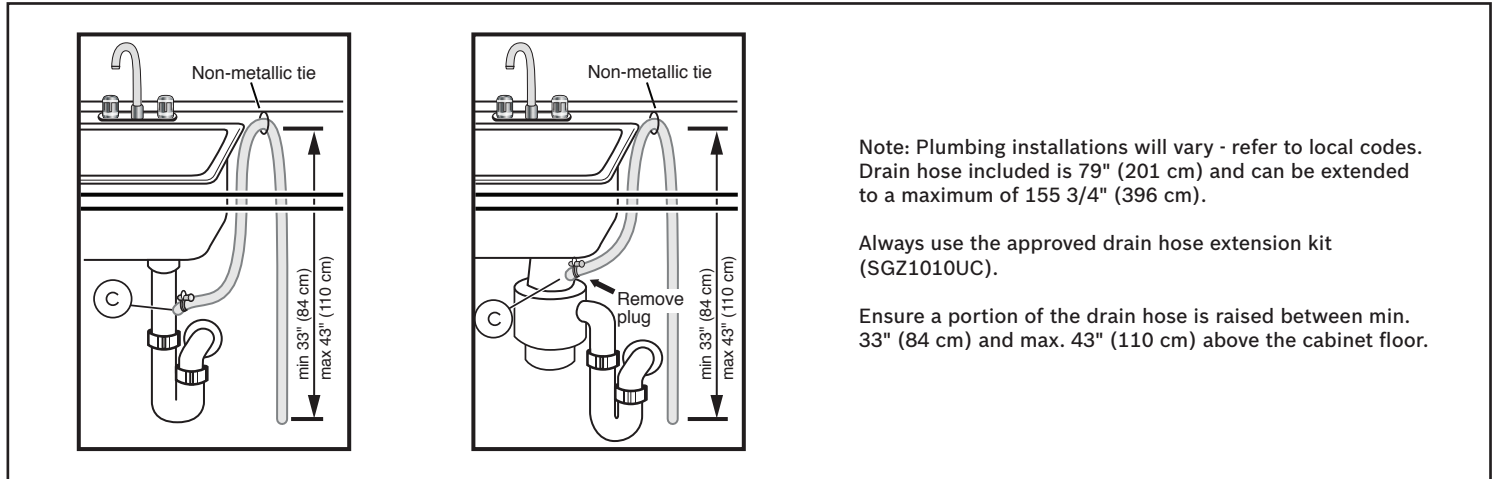

**Accessories:** To purchase Bosch accessories, cleaners & parts please visit [www.bosch-home.com/us/store](http://www.bosch-home.com/us/store) or call 1-800-944-2904 (Mon to Fri 5 am to 6 pm PST, Sat 6 am to 3 pm PST).

**Notes:** All height, width and depth dimensions are shown in inches. BSH reserves the absolute and unrestricted right to change product materials and specifications, at any time, without notice. Consult the product's installation instructions for final dimensional data and other details prior to making cutout.

**Warranties:** Please see Use & Care manual or Bosch website for statement of limited warranty.

**For more information on our entire line of products, go to [www.bosch-home.com/us](http://www.bosch-home.com/us) or call 1-800-944-2904**

© BSH Home Appliances Corporation. All rights reserved. Bosch is a registered trademark of Robert Bosch GmbH.