



OWNER'S MANUAL

Bar Refrigerator with Icemaker

TABLE OF CONTENTS

MODEL INFORMATION	2
CONSUMER SUPPORT	3
SAFETY INFORMATION	4
CONTROLS AND FEATURES	8
SABBATH MODE	11
CARE AND CLEANING	12
TROUBLESHOOTING	14
LIMITED WARRANTY	19

MODEL INFORMATION

MODEL NUMBERS

ZIBI240HII, ZIBS240NSS

WRITE DOWN THE MODEL AND SERIAL NUMBERS

These will be on a label on the ceiling inside the bar refrigerator with icemaker

Use these numbers in any correspondence or service calls concerning your appliance.

Please write these numbers here:

Model Number

Serial Number

CONSUMER SUPPORT

MONOGRAM WEBSITE

Have a question or need assistance with your appliance? Try the Monogram website 24 hours a day, any day of the year! You can also shop for more great Monogram products and take advantage of all our on-line support services designed for your convenience.
In the US: monogram.com
In Canada: monogram.ca

REGISTER YOUR APPLIANCE

Register your new appliance on-line at your convenience! Timely product registration will allow for enhanced communication and prompt service under the terms of your warranty, should the need arise. You may also mail in the pre-printed registration card included in the packing material. In the US: monogram.com/register
In Canada: Prodsupport.mabe.ca/crm/Products/ProductRegistration.aspx

SCHEDULE SERVICE

Expert Monogram repair service is only one step away from your door. Get on-line and schedule your service at your convenience any day of the year.
In the US: monogram.com
In Canada: monogram.ca

REMOTE CONNECTIVITY

For assistance with wireless network connectivity (for models with remote enable), visit our website at monogram.com/connect in the US only.

PARTS AND ACCESSORIES

Individuals qualified to service their own appliances can have parts or accessories sent directly to their homes (VISA, MasterCard and Discover cards are accepted). Order on-line today 24 hours every day.
In the US: monogram.com/use-and-care/parts

Instructions contained in this manual cover procedures to be performed by any user. Other servicing generally should be referred to qualified service personnel. Caution must be exercised, since improper servicing may cause unsafe operation.

Customers in Canada should consult the nearest MC Commercial service center or visit our website at monogram.ca.

CONTACT US

If you are not satisfied with the service you receive from Monogram, contact us on our website with all the details including your phone number, or write to:

In the US: General Manager, Customer Relations | Monogram Appliances, Appliance Park | Louisville, KY 40225
monogram.com/contact

IMPORTANT SAFETY INFORMATION

READ ALL INSTRUCTIONS BEFORE USING THE APPLIANCE

▲ WARNING To reduce the risk of fire, explosion, electric shock, or injury when using your refrigerator, follow these basic safety precautions:

- Use this appliance only for its intended purpose as described in this Owner's Manual.
- This refrigerator must be properly installed and located in accordance with the Installation Instructions before it is used.
- Unplug the refrigerator before making repairs, replacing a light bulb, or cleaning.
NOTE: Power to the refrigerator cannot be disconnected by any setting on the control panel.
NOTE: Repairs must be performed by a qualified Service Professional.
- Replace all parts and panels before operating.
- Keep flammable materials and vapors away from the appliance.
- Do not store explosive substances such as aerosol cans with a flammable propellant in this appliance.
- Do not use an extension cord.
- To prevent suffocation and entrapment hazards to children, remove the fresh food and freezer doors from any refrigerator before disposing of it or discontinuing its use.
- To avoid serious injury or death, children should not stand on, or play in or with the appliance.
- Children and persons with reduced physical, sensory or mental capabilities or lack of experience and knowledge can use this appliance only if they are supervised or have been given instructions on safe use and understand the hazards involved.
- This appliance is intended to be used in household and similar applications such as: staff kitchen areas in shops, offices and other working environments; farm houses; by clients in hotels, motels, bed & breakfast and other residential environments; catering and similar non-retail applications.
- Connect to potable water supply only. A cold water supply is required for automatic icemaker operation. The water pressure must be between 40 and 120 psi (275-827 kilopascals).
- Do not apply harsh cleaners to the refrigerator. Certain cleaners will damage plastic which may cause parts such as the door or door handles to detach unexpectedly. See the Care and Cleaning section for detailed instructions.

▲ CAUTION To reduce the risk of injury when using your refrigerator, follow these basic safety precautions.

- Do not clean glass shelves or covers with warm water when they are cold. Glass shelves and covers may break if exposed to sudden temperature changes or impact, such as bumping or dropping. Tempered glass is designed to shatter into many small pieces if it breaks.
- **Keep fingers out of the "pinch point" areas:** clearances between the door and between the door and cabinet are necessarily small. Be careful closing the door when children are in the area.
- **In refrigerators with automatic icemakers,** avoid contact with the moving parts of the ejector mechanism, or with the heating element that releases the cubes. Do not place fingers or hands on the automatic ice making mechanism while the refrigerator is plugged in.

▲ WARNING  **FIRE OR EXPLOSION HAZARD Flammable Refrigerant**

This appliance contains isobutane refrigerant, also known as R600a, a natural gas with high environmental compatibility. However, it is also combustible. Adhere to the warnings below to reduce the risk of injury or property damage.

1. When handling, installing and operating the appliance, care should be taken to avoid damage to the refrigerant tubing.
2. Service shall only be performed by authorized service personnel. Use only manufacturer-authorized service parts.
3. Dispose of refrigerator in accordance with the Federal and Local Regulations. The flammable refrigerant and insulation material used in this product require special disposal procedures. Contact your local authorities for the environmentally safe disposal of your refrigerator.
4. Keep ventilation openings in the appliance enclosures or in the built-in structure clear of obstruction.
5. To remove frost, scrape with a plastic or wood spatula or scraper. Do not use an ice pick or a metal or sharp-edged instrument as it may puncture the appliance liner and then the flammable refrigerant tubing behind it.
6. Do not use electrical appliances inside the food storage compartment of the appliance.
7. Do not use any electrical device to defrost your appliance.
8. Do not damage the refrigerant circuit.

READ AND SAVE THESE INSTRUCTIONS

IMPORTANT SAFETY INFORMATION

READ ALL INSTRUCTIONS BEFORE USING THE APPLIANCE

INSTALLATION

⚠ WARNING FIRE OR EXPLOSION HAZARD

Keep flammable materials and vapors away from refrigerator. Failure to do so can result in fire, explosion, or death.

CONNECTING ELECTRICITY

⚠ WARNING Electrical Shock Hazard.

Plug into a grounded 3-prong outlet

Do not remove the ground prong

Do not use an adapter

Do not use an extension cord.

Failure to follow these instructions can result in death, fire, or electrical shock.

Do not, under any circumstances, cut or remove the third (ground) prong from the power cord. For personal safety, this appliance must be properly grounded.

The power cord of this appliance is equipped with a 3-prong (grounding) plug which mates with a standard 3-prong (grounding) wall outlet to minimize the possibility of electric shock hazard from this appliance.

Have the wall outlet and circuit checked by a qualified electrician to make sure the outlet is properly grounded.

Where a standard 2-prong wall outlet is encountered, it is your personal responsibility and obligation to have it replaced with a properly grounded 3-prong wall outlet. Do not use an adapter.

Use of a GFI (Ground Fault Interrupter) is not recommended for the fresh-food refrigerator.

A 115 Volt AC, 60 Hz, 15- or 20-amp fused, grounded electrical supply is required. This provides the best performance and also prevents overloading house wiring circuits which could cause a fire hazard from overheated wires.

Never unplug your refrigerator by pulling on the power cord. Always grip plug firmly and pull straight out from the outlet.

Immediately discontinue use of a damaged supply cord. If the supply cord is damaged, it must be replaced by a qualified service professional with an authorized service part from the manufacturer.

When moving the refrigerator away from the wall, be careful not to roll over or damage the power cord.

DO NOT USE AN ADAPTER PLUG TO CONNECT THE FRESH-FOOD REFRIGERATOR TO A 2-PRONG OUTLET.

PROPER DISPOSAL OF YOUR OLD REFRIGERATOR

⚠ WARNING SUFFOCATION AND ENTRAPMENT HAZARD

Failure to follow these disposal instructions can result in death or serious injury

IMPORTANT: Child entrapment and suffocation are not problems of the past. Junked or abandoned refrigerators are still dangerous even if they will sit for “just a few days.” If you are getting rid of your old refrigerator, please follow the instructions below to help prevent accidents.

Before You Throw Away Your Old Appliance

- Take off the fresh food and freezer doors.
- Leave the shelves in place so that children may not easily climb inside.

Refrigerant and Foam Disposal:

Dispose of appliance in accordance with Federal and Local Regulations. Flammable refrigerant and insulation material used requires special disposal procedures. Contact your local authorities for the environmentally safe disposal of your appliance.

READ AND SAVE THESE INSTRUCTIONS

RENSEIGNEMENTS IMPORTANTS CONCERNANT LA SÉCURITÉ

LISEZ TOUTES LES INSTRUCTIONS AVANT D'UTILISER LE RÉFRIGÉRATEUR

⚠ AVERTISSEMENT

Pour réduire le risque d'incendie, d'explosion, de choc électrique ou de blessures lorsque vous utilisez votre réfrigérateur, veuillez suivre ces consignes de sécurité :

- N'utilisez l'appareil que pour son usage prévu, comme décrit dans le présent manuel.
- Ce réfrigérateur doit être correctement installé conformément aux instructions d'installation avant toute utilisation.
- Débranchez le réfrigérateur avant d'effectuer une réparation, de remplacer une ampoule ou de le nettoyer.
Remarque : L'alimentation du réfrigérateur ne peut être déconnectée par aucune des fonctions sur le panneau de commande.
Remarque : Les réparations doivent être effectuées par un professionnel qualifié.
- Remettez toutes les pièces et panneaux en place avant d'utiliser l'appareil.
- Conservez les matériaux et vapeurs inflammables à l'écart de votre réfrigérateur.
- N'entreposez pas dans cet électroménager des substances explosives telles que des bombes aérosols qui contiennent un gaz propulseur.
- N'utilisez pas un cordon de rallonge.
- Afin de prévenir les risques d'asphyxie et d'enfermement des enfants, enlevez les portes des compartiments réfrigérateur et congélateur avant de mettre le réfrigérateur au rebut ou d'en cesser l'usage.
- Afin de prévenir les accidents graves ou la mort, les enfants ne doivent pas se tenir ni jouer dans ou sur l'électroménager.
- Les enfants et les personnes dont les capacités sont réduites sur le plan physique, sensoriel ou mental, ou qui manquent d'expérience ou de connaissances, peuvent utiliser cet électroménager seulement si elles sont surveillées ou ont reçues des consignes de sécurité sur son usage et les risques y sont associés.
- Cet électroménager est conçu pour une utilisation domestique et applications similaires : salle du personnel dans une usine, un bureau ou d'autres lieux de travail; maison de ferme; clients dans un hôtel, un motel, un gîte touristique et d'autres lieux résidentiels; approvisionnement et applications similaires non reliées au commerce de détail.
- Raccordez l'appareil à une alimentation d'eau potable seulement. Une alimentation d'eau froide est requise pour faire fonctionner la machine à glaçons et le pichet à remplissage automatique. La pression d'eau doit se situer entre 40 et 120 psi. (275 à 827 kPa)
- N'appliquez pas de nettoyants corrosifs sur le réfrigérateur. Certains nettoyants endommagent le plastique et peuvent ainsi causer le détachement inopiné de pièces telles que porte ou poignées de porte. Voyez la section Entretien et nettoyage pour des instructions détaillées.

⚠ ATTENTION

Pour réduire le risque de blessures lorsque vous utilisez votre réfrigérateur, veuillez suivre ces consignes de sécurité.

- Ne nettoyez pas les clayettes ou les couvercles en verre avec de l'eau tiède quand ceux-ci sont froids. Les clayettes et couvercles en verre peuvent se casser s'ils sont exposés à des changements soudains de température ou si vous les cognez ou les faites tomber. Le verre trempé est conçu pour se briser en petits morceaux en cas de casse
- **Éloignez les doigts des parties du réfrigérateur où l'on peut facilement se pincer** : les espaces entre les portes et entre les portes et les placards sont toujours étroits. Soyez prudent lorsque vous fermez les portes de l'appareil en présence des enfants.
- **Si votre réfrigérateur est doté d'une machine à glaçons automatique**, évitez le contact avec les pièces mobiles du mécanisme éjecteur, ou avec l'élément chauffant qui libère les glaçons. Ne posez pas les doigts ou les mains sur le mécanisme de la machine à glaçons automatique pendant que le réfrigérateur est branché.

⚠ AVERTISSEMENT



RISQUE D'INCENDIE OU D'EXPLOSION Réfrigérant inflammable

Cet appareil contient un gaz réfrigérant avec isobutane aussi connu sous R600a, un gaz naturel à compatibilité élevée avec l'environnement. Il s'agit cependant d'un combustible. Observez les consignes de sécurité ci-dessous afin de réduire le risque de blessure ou de dommage à la propriété.

1. Lors de la manipulation, de l'installation et de l'utilisation de cet appareil, prenez soin de ne pas endommager la tubulure du réfrigérant.
2. L'entretien ou la réparation doivent être effectués par un personnel de service autorisé. Utilisez seulement des pièces de rechange autorisées par le fabricant.
3. Mettez le réfrigérateur au rebut conformément aux réglementations fédérales et locales. Le gaz réfrigérant inflammable et les matériaux d'isolation utilisés dans ce produit requièrent des procédures de mise au rebut spéciales. Communiquez avec les autorités locales compétentes pour la mise au rebut de votre réfrigérateur sans danger pour l'environnement.
4. N'obstruez pas les orifices de ventilation dans les enceintes ou la structure d'encastrement de l'appareil.
5. Pour enlever le givre, grattez à l'aide d'un grattoir ou d'une spatule en plastique ou en bois. N'utilisez pas de pic à glace ou un instrument métallique à bord tranchant pour éviter de perforer la cuve interne du électroménager et la tubulure du gaz réfrigérant derrière cette dernière.
6. N'utilisez pas d'appareils électriques dans le compartiment de rangement des aliments de cet appareil.
7. N'utilisez aucun appareil électrique pour dégivrer votre électroménager.
8. N'endommagez pas le circuit du réfrigérant.

LEA Y GUARDE ESTAS INSTRUCCIONES

RENSEIGNEMENTS IMPORTANTS CONCERNANT LA SÉCURITÉ

LISEZ TOUTES LES INSTRUCTIONS AVANT D'UTILISER LE RÉFRIGÉRATEUR

INSTALLATION

AVERTISSEMENT **RISQUE D'INCENDIE OU D'EXPLOSION**

Conservez les matériaux et vapeurs inflammables à l'écart de votre réfrigérateur. Une explosion, un incendie voire la mort pourrait en résulter.

BRANCHEMENTS ÉLECTRIQUES

AVERTISSEMENT **RISQUE DE CHOC ÉLECTRIQUE**

Branchez l'appareil dans une prise triple avec terre.

Ne retirez pas la broche de terre.

N'utilisez pas d'adaptateur.

N'utilisez pas un cordon de rallonge.

Le non-respect de ces instructions peut entraîner des risques d'incendies, des chocs électriques ou la mort.

Ne coupez pas ou n'enlevez pas, sous aucun prétexte, la troisième broche de mise à la terre du cordon d'alimentation. Pour des raisons de sécurité, cet appareil doit être correctement mis à la terre.

Le cordon d'alimentation de cet appareil est équipé d'une fiche à trois broches (pour une mise à la terre) qui s'adapte à la prise de courant standard à 3 broches (pour une mise à la terre) pour minimiser les risques de chocs électriques par cet appareil.

Faites vérifier la prise murale et le circuit électrique par un électricien qualifié pour s'assurer que le système est correctement mis à la terre.

Dans le cas d'une prise biphasée, l'installateur a la responsabilité et l'obligation de la remplacer par une prise triphasée correctement mise à la terre. N'utilisez pas d'adaptateur.

L'utilisation d'un disjoncteur différentiel de fuite à la terre (DDFT) n'est pas recommandée pour le réfrigérateur.

Une alimentation électrique à 115 volts CA, 60 Hz, avec un fusible de 15 ou 20 ampères et une mise à la terre est

nécessaire. Ceci permet d'obtenir un meilleur rendement et évite de surcharger les circuits électriques du domicile qui risque d'occasionner un incendie en surchauffant.

Ne débranchez jamais le réfrigérateur en tirant sur le cordon d'alimentation. Prenez toujours fermement la fiche en main et tirez pour la sortir de la prise.

Cessez immédiatement d'utiliser un cordon électrique endommagé. Si le cordon électrique est endommagé, son remplacement doit être effectué par un technicien en réparation qualifié au moyen d'un cordon de rechange autorisé par le fabricant.

Lorsque vous éloignez votre réfrigérateur du mur, faites attention à ne pas le faire rouler sur le cordon d'alimentation afin de ne pas l'endommager.

N'UTILISEZ JAMAIS UNE PRISE À ADAPTATEUR POUR LE RÉFRIGÉRATEUR POUR DENRÉES FRAÎCHES À UNE PRISE BIPOLAIRE.

MISE AU REBUT APPROPRIÉE DE VOTRE ANCIEN APPAREIL

AVERTISSEMENT **RISQUE DE SUFFOQUER OU D'Y ÊTRE EMPRISONNÉ**

Le non-respect de ces instructions d'élimination peut entraîner la mort ou des blessures graves.

IMPORTANT: Les enfants pris au piège ou morts d'asphyxie sont toujours d'actualité. Les réfrigérateurs et congélateurs abandonnés sont toujours aussi dangereux, même si on n'attend que «quelques jours» pour s'en débarrasser. Si vous ne gardez pas votre ancien réfrigérateur ou congélateur, veuillez suivre les directives ci-dessous afin de prévenir les accidents.

Avant de vous débarrasser de votre ancien appareil :

- Démontez les portes.
- Laissez les clayettes en place afin d'empêcher les enfants de grimper à l'intérieur.

Mise au rebut des produits réfrigérants et en mousse

Mettez l'électroménager au rebut conformément à la réglementation fédérale et locale. Les matériaux réfrigérants et isolants inflammables utilisés nécessitent des procédures d'élimination particulières. Communiquez avec les autorités locales pour connaître la façon de mettre votre électroménager au rebut qui soit respectueuse de l'environnement.

LEA Y GUARDE ESTAS INSTRUCCIONES

CONTROLS AND FEATURES

Temperature Controls

The temperature display shows the actual temperature of the fresh-food refrigerator. The actual temperature may vary slightly from the set temperature based on factors such as door openings, amount of food and room temperature.

To change the temperature setting, press the + or – pads until you reach the desired set temperature. After 5 seconds, the display will return to the actual temperature.

After making adjustments, allow 12 to 24 hours for the fresh-food refrigerator to reach the temperature you have set and before making any further adjustments.

Temperature Settings

Minimum: 34°F (1.1°C)

Maximum: 45°F (7.2°C)

NOTE: The icemaker temperature is not displayed.

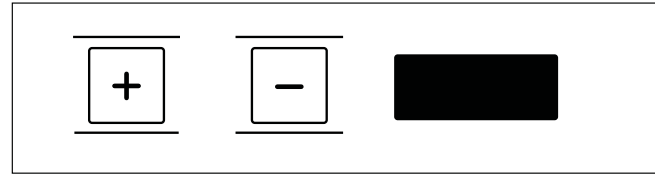

Child Control Lockout

This child control lockout feature prevents unwanted changes to your temperature settings.

After the desired temperature is set, the temperature can be locked. To lock, press both the + and – pads at the same time for five seconds. To unlock, press both + and – pads for five seconds.

Unit ON/OFF

This pad stops cooling in the bar refrigerator with icemaker, turns off the temperature controls and removes power to the light circuit.

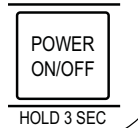

NOTE: The icemaker is on a separate ON/OFF switch. To remove power from the icemaker See Automatic Icemaker section.

Press this pad for a minimum of 3 seconds to turn the bar refrigerator with icemaker on or off, or unplug the unit for long vacations or absences, or when cleaning the unit or changing the light bulb.

Glass Shelves

Tempered glass shelves in the bar refrigerator with icemaker are removable for easy cleaning or for storing larger items.

To remove a shelf, open the door completely to avoid potential damage to the gasket. Lift up on the back of the shelf slightly. Tilt the shelf to one side at an angle while pulling forward.

Appearance may vary

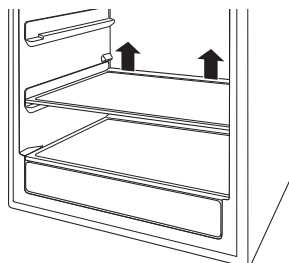

To remove, lift up on the back of the shelf

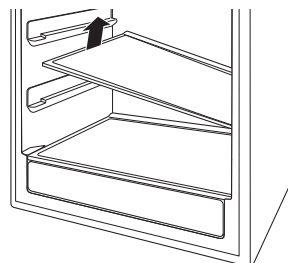

Tilt the shelf at an angle while removing or replacing

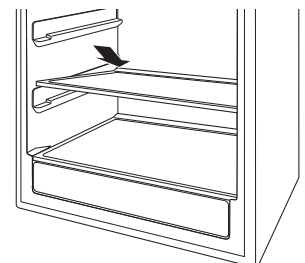

Place in slots when replacing the shelf

CONTROLS AND FEATURES

Automatic Icemaker

The icemaker will produce seven cubes per cycle—approximately 100–130 cubes in a 24-hour period, depending on freezer compartment temperature, room temperature, number of door openings and other use conditions.

If the bar refrigerator with icemaker is operated before the water connection is made to the water valve, set the icemaker power switch to **Off**.

When the unit has been connected to the water supply, set the icemaker power switch to **On**. The green light will come on.

The icemaker will fill with water when it cools to 15°F (–10°C). A newly installed bar refrigerator with icemaker may take 12 to 24 hours to begin making ice cubes.

You will hear a buzzing sound each time the icemaker fills with water.

Throw away the first few batches of ice to allow the water line to clear.

Be sure nothing interferes with the sweep of the feeler arm.

When the bin fills to the level of the feeler arm, the icemaker will stop producing ice. It is normal for several cubes to be joined together.

If ice is not used frequently, old ice cubes will become cloudy, taste stale and shrink.

If ice cubes get stuck in the icemaker, the green power light will blink. To correct this, set the icemaker power switch to **Off** and remove the cubes. Set the icemaker power switch to **On** to restart the icemaker.

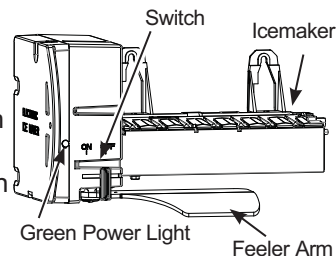

After the icemaker has been turned on again, there will be a delay of about 45 minutes before the icemaker resumes operations.

NOTE: In homes with lower-than-average water pressure, you may hear the icemaker cycle multiple times when making one batch of ice.

⚠ CAUTION

Avoid contact with the moving parts of the ejector mechanism, or with the heating element that releases the cubes. Do not place fingers or hands on the automatic ice making mechanism while the refrigerator is plugged in.

⚠ ATTENTION

Évitez le contact avec les pièces mobiles du mécanisme éjecteur, ou avec l'élément chauffant qui libère les glaçons. Ne posez pas les doigts ou les mains sur le mécanisme de la machine à glaçons automatique pendant que le réfrigérateur est branché.

Ice Storage Bin

To remove, pull the icemaker drawer fully open and remove the transportable ice storage bin by lifting up and out.

NOTE: Ice can fall behind the ice storage bin. Prior to replacing the bin, check for any fallen ice.

If the ice storage bin is removed from the refrigerator for an extended period of time, we recommend setting the icemaker power switch to **Off**.

To replace, grasp the side of the right side of the bin with the higher edge so that the angled side is against the drawer front. Lower the bin into place and close the drawer.

NOTICE: Failure to install properly could cause potential damage to the icemaker.

The ice storage bin is dishwasher safe, top rack only.

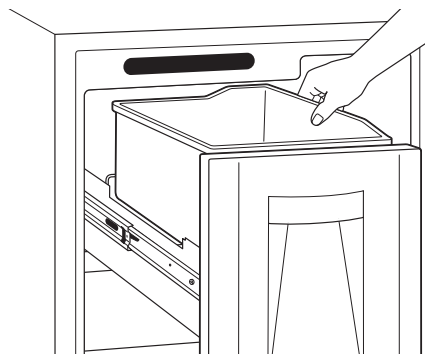

CONTROLS AND FEATURES

Ice Scoop

The bar refrigerator with icemaker includes an ice scoop in the ice storage bin. To maximize ice bin capacity, store the ice scoop as shown. Do NOT wash the ice scoop in the dishwasher. For cleaning, handwash in mild soapy water or use the baking soda solution noted in Cleaning the inside section.

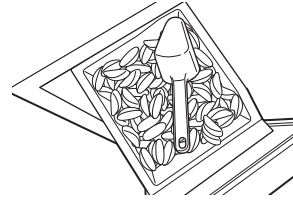

Loading Tips And Suggestions

The bottom full extension drawer holds five bottles and is loaded with necks facing the rear. Tall bottles should not be loaded on the bottom drawer because they may prevent the door from closing.

- Do not block the thermistor, located on the right-hand side, just above the third shelf of the bar refrigerator with icemaker. Blocking the thermistor could impair the air circulation and temperature control.

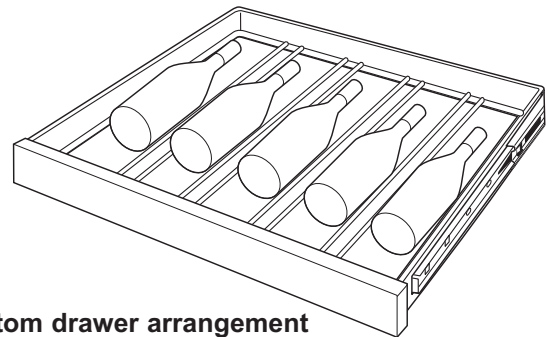

Bottom drawer arrangement

Removing Full Extension Drawers

To remove:

1. Pull the full extension drawer out to the STOP position.
2. Push the tab on right drawer guide down while pulling the tab on left guide up, and pull the drawer out.

To replace:

1. Push the drawer slide arm back into the unit.
2. Pull the small slide sub-assembly completely forward.
3. Insert the sides of the drawer back into the guides.
4. Push until the tabs lock into place.

NOTE: Make sure the tabs on the full extension drawer guides are fully engaged before loading any bottles. Pull the drawers out all the way to the STOP position and push back in several times to make sure locking tabs are properly engaged.

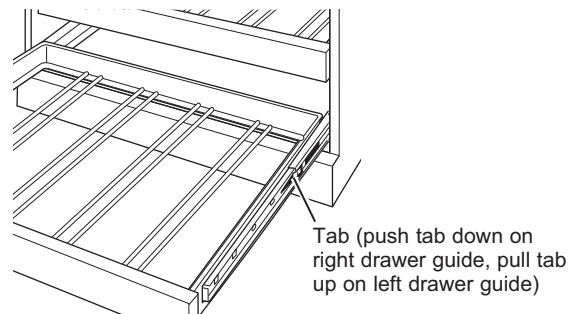

Appearance may vary

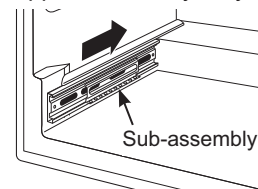

To replace, push drawer slide arm back into unit

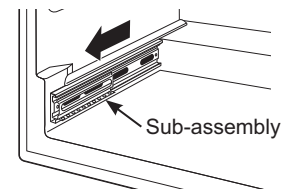

Pull small slide sub-assembly completely forward

Interior Fan

The interior fan is located in the rear wall of the bar refrigerator with icemaker and is designed to run continuously to help maintain the proper cooling temperature.

In most instances, the interior fan will run when the door is open. However, it will not operate when the door is opened during a defrost cycle.

SABBATH MODE

The Sabbath Mode was designed for use on the Jewish Sabbath and Holidays. The Sabbath Mode feature makes it possible for observant Jews to use the bar refrigerator with icemaker during the duration of the holiday.

The Sabbath Mode feature can be set to override typical reactions caused by your interaction with the bar refrigerator with icemaker. While in the Sabbath Mode, your appliance will still operate. However, it will not respond to your actions.

While in the Sabbath Mode, you may notice the fan running when the door is opened, however, this is not a result of your actions. The compressor and fan will operate at predetermined times. On models with defrost heater, the defrost heater will continue to defrost and will be activated on a timer. The defrost heater will not defrost as a result of door openings or any consumer actions

ON/OFF - To activate the Sabbath Mode, press and hold down the + and **ON/OFF** buttons on the control panel for at least 7 seconds. **SAb** will be displayed on the control. **SAb** will remain in the display and all the control settings will be frozen and stay in the last mode before entering Sabbath Mode. Controls and lights will not work until the + and **ON/OFF** buttons are held again for 7 seconds. The display will show "out" for 1 second and then resume the last operating mode.



ICEMAKER - The icemaker will continue to operate. The icemaker can be disabled by turning it off prior to the Sabbath.

CARE AND CLEANING

⚠️ WARNING **Electrical Shock Hazard.**

Turn the fresh-food refrigerator OFF or unplug the unit before cleaning.

Turn the fresh-food refrigerator OFF by pressing the button on the control panel a minimum of 3 seconds until the light and temperature display turn off.

⚠️ AVERTISSEMENT **Risque de choc électrique.**

Éteignez (Off) le réfrigérateur pour denrées fraîches ou débranchez-le avant le nettoyage. Éteignez (Off) le réfrigérateur pour denrées fraîches en appuyant sur le bouton du panneau de commande durant un minimum de 3 secondes jusqu'à ce que la lampe et l'affichage de température s'éteignent.

Gasket

The main door and icemaker compartment gaskets may be cleaned with mild soap and water, a baking soda solution or a mild scouring powder. Rinse and dry well after cleaning.

After cleaning the gaskets, apply a thin layer of paraffin wax or petroleum jelly to the gaskets. This helps keep the gaskets from sticking and bending out of shape.

Light Bulb Replacement

Turn the bar refrigerator with icemaker OFF before replacing the light bulb.

To remove the light shield, push in the tab on the left side of the shield and lower it. Replace with a 15 watt appliance bulb or a 4.5 watt UL Listed LED Lamp or call 800.GE.CARES (800.432.2737) during normal business hours to order service part.

⚠️ WARNING  **Electrical Shock Hazard.**
Unplug the appliance before replacing the light bulb.
If the unit is in a built-in location, remove power at the circuit breaker.

Power Failure

If the power fails, open the door as infrequently as possible to maintain the temperature.

Preparing for Vacation

For long vacations or absences, remove food and turn the fresh-food refrigerator OFF. Clean the interior (see Cleaning the Inside section).

For shorter vacations, remove perishable foods and leave controls at regular settings. However, if the room temperature is expected to drop below 60°F (16°C), follow the same instructions as for long vacations.

Set the icemaker power switch to the O (off) position and be sure to shut off the water supply to the refrigerator.

Preparing to Move

Secure all loose items such as shelves and drawers by taping them securely in place to prevent damage.

Be sure the bar refrigerator with icemaker stays in an upright position during moving.

CARE AND CLEANING

⚠ WARNING Electrical Shock Hazard.

Turn the bar refrigerator with icemaker OFF or unplug the unit before cleaning.

Turn the outdoor/indoor refrigerator OFF by pressing the button on the control panel a minimum of 3 seconds until the light and temperature display turn off.

⚠ AVERTISSEMENT Risque de choc électrique.

Éteignez (Off) le réfrigérateur de bar avec machine à glaçons ou débranchez-le avant le nettoyage. Éteignez (Off) le réfrigérateur de bar avec machine à glaçons en appuyant sur le bouton du panneau de commande durant un minimum de 3 secondes jusqu'à ce que la lampe et l'affichage de température s'éteignent.

Cleaning the Outside

Directions for Cleaning Outside Surfaces, Door Handles, and Trim

DO USE	DO NOT USE
Soft, clean cloth or sponge	Abrasive cloths, scrubbing sponges (with or without soap), scouring or steel wool pads
Mild detergent mixed with warm water Approved stainless steel cleaners; Visit the Monogram Appliances parts store for approved stainless steel cleaners: Monogram.com Cleaners with oxalic acid such as Bar Keepers Friend Soft Cleanser™ can be used to remove surface rust, tarnish and small blemishes on stainless steel surfaces only	Abrasive powders or sprays Window Sprays or Ammonia Citrus or plant oil-based cleaners Acidic or vinegar-based cleaners Oven cleaners Cleaners containing acetone (propanone) Any cleaner with WARNING about plastic contact

NOTE: DO NOT allow stainless steel cleaner to come in contact with any plastic parts such as trim pieces, handle hardware and liners. If unintentional contact of cleaners with plastic parts does occur, clean plastic part with a sponge and mild detergent mixed with warm water.

Cleaning the Inside

Unplug the bar refrigerator with icemaker before cleaning. If this is not practical, turn the unit OFF and wring excess moisture out of the cloth or sponge when cleaning around switches, lights or controls.

Use warm water and baking soda solution—about a tablespoon (15 ml) of baking soda to a quart (1 liter) of water. This both cleans and neutralizes odors. Thoroughly rinse and wipe dry.

Other parts of the bar refrigerator with icemaker—including the door gaskets, drawer, icemaker, ice scoop and glass shelves—can be cleaned the same way. Only the ice storage bin is dishwasher safe, top rack only.

⚠ WARNING Risk of fire or explosion. Flammable refrigerant used.

To remove frost, scrape with a plastic or wood spatula or scraper. Do not use an ice pick or a metal or sharp-edged instrument as it may puncture the appliance liner and then the flammable refrigerant tubing behind it.

Do not use any electrical device to defrost your appliance.

⚠ AVERTISSEMENT Risque d'incendie et d'explosion. Contient un fluide frigorigène inflammable.

Éliminez le givre en grattant avec une spatule en plastique ou en bois ou un racloir. N'utilisez pas de pic à glace ou un instrument métallique à bord tranchant pour éviter de perforer la cuve interne du électroménager et la tubulure du gaz réfrigérant derrière cette dernière. N'utilisez aucun appareil électrique pour effectuer le dégivrage de votre congélateur.

⚠ CAUTION Do not clean glass shelves or covers with warm water when they are cold. Glass shelves and covers may break if exposed to sudden temperature changes or impact, such as bumping or dropping. Tempered glass is designed to shatter into many small pieces if it breaks.

⚠ ATTENTION Ne nettoyez pas les clayettes ou les couvercles en verre avec de l'eau tiède quand ceux-ci sont froids. Les clayettes et couvercles en verre peuvent se casser s'ils sont exposés à des changements soudains de température ou si vous les cognez ou les faites tomber. Le verre trempé est conçu pour se briser en petits morceaux en cas de casse

TROUBLESHOOTING

Newer appliances sound different from older appliances. Modern appliances have more features and use newer technology.

Do you hear what I hear? These sounds are normal.

HUMMM... WHOOSH...

- The new high efficiency compressor may run faster and longer than your old appliance and you may hear a high-pitched hum or pulsating sounds while it is operating.
- Sometimes the appliance runs for an extended period, especially when the doors are opened frequently.
- You may hear a whooshing sound when the doors close. This is due to pressure equalizing within the appliance.
- The cabinet fan runs continuously except when the door is opened.

WHIR!



- You may hear the fans spinning at high speeds. This happens when the appliance is first plugged in, when the door is opened frequently or when a large amount of food is added to the appliance. The fans help maintain desired temperatures.
- If the door is open for over 3 minutes, you may hear the fans come on in order to cool the light bulbs.
- The fans change speeds in order to provide optimal cooling and energy savings.

CLICKS, POPS, CRACKS and CHIRPS

- You may hear clicking, cracking or popping sounds when the appliance cools to the correct temperature or immediately following defrost.
- The electronic control board may cause a clicking sound when relays activate to control appliance components.
- Expansion and contraction of cooling coils during and after defrost can cause cracking or popping sounds.
- After an icemaking cycle, you may hear the ice cubes dropping into the ice bucket.

WATER SOUNDS



- The flow of refrigerant through the freezer cooling coils may make a gurgling noise like boiling water.
- Water dropping on the defrost heater can cause a sizzling, popping or buzzing sound during the defrost cycle.
- A water dripping noise may occur during the defrost cycle as ice melts from the evaporator and flows into the drain pan.
- Closing the door may cause a gurgling sound due to pressure equalization.



For additional information on normal icemaker and dispenser operating sounds, see the Automatic Icemaker section in the Bar Refrigerator with Icemaker Owner's Manual only.

TROUBLESHOOTING

PROBLEM	POSSIBLE CAUSE
APPLIANCE DOES NOT OPERATE	<ul style="list-style-type: none"> • Appliance may be in defrost cycle when compressor motor does not operate for about 30 minutes. • Appliance is so quiet that most of the time you will hear low or no operating noise. • Controls are set to OFF. Press ON/OFF button on control panel for a minimum of 3 seconds. • If interior light is not on, appliance may not be plugged in at wall outlet. Push the plug completely into the wall outlet. • The fuse is blown/circuit breaker is tripped. Replace fuse or reset the breaker. • The appliance is in showroom mode. Unplug it and plug it back in.
VIBRATION OR RATTLING (Slight vibration is normal.)	<ul style="list-style-type: none"> • Adjust the leveling legs as shown in the Installation Instructions.
COMPRESSOR MOTOR OPERATES FOR LONG PERIODS OR CYCLES ON AND OFF FREQUENTLY	<ul style="list-style-type: none"> • Normal when appliance is first plugged in. Wait 24 hours for the appliance to completely cool down. • Often occurs when large amounts of food are placed in appliance. This is normal. • Door left open or package holding door open. • Hot weather or frequent door openings. This is normal. • Temperature control set at the coldest setting. See Temperature Control.
FRESH FOOD COMPARTMENT TOO WARM	<ul style="list-style-type: none"> • Temperature control not set cold enough. See Temperature Control. Allow 12 to 24 hours for temperature to change. • Warm weather or frequent door openings. • Door left open for long time. • Package may be holding door open. • Thermistor may be blocked, which can affect the overall temperature. The thermistor is located on the right hand side just above the top shelf.
FROST OR ICE CRYSTALS ON REAR WALL	<ul style="list-style-type: none"> • Too frequent or too long door openings. • Thermistor may be blocked, which can affect the overall temperature. The thermistor is located on the right hand side just above the top shelf.
AUTOMATIC ICEMAKER DOES NOT WORK	<ul style="list-style-type: none"> • Icemaker power switch is in the Off position. • Water supply turned off or not connected. See Installation Instructions. • Freezer compartment too warm. Allow 24 hours for the appliance to completely cool down. • Piled up cubes in storage bin cause icemaker to shut off. Level cubes in bin. • Ice cubes stuck in icemaker (green power light on the icemaker is blinking). Turn off the icemaker, remove cubes and turn the icemaker back on.
FREQUENT “BUZZING” SOUND	<ul style="list-style-type: none"> • Icemaker power switch is in the On position, but the water supply to the appliance has not been connected or is kinked. Set the power switch to the Off position. Keeping it in the On position will damage the water valve or straighten the water supply line.
ICE CUBES HAVE ODOR/ TASTE	<ul style="list-style-type: none"> • Old cubes need to be discarded. • Ice storage bin needs to be emptied and washed. • Unsealed packages in fresh food compartment may be transmitting odor/taste to ice cubes. • Interior of appliance needs cleaning. See Care and Cleaning.

TROUBLESHOOTING

PROBLEM	POSSIBLE CAUSE
SLOW ICE CUBE FREEZING	<ul style="list-style-type: none"> • Door may have been left open.
APPLIANCE HAS ODOR	<ul style="list-style-type: none"> • Interior needs cleaning. See Care and Cleaning. • Keep open box of baking soda in appliance; replace every 3 months.
DOOR NOT CLOSING PROPERLY	<ul style="list-style-type: none"> • Door gasket is sticking or folding over. Apply petroleum jelly or paraffin wax to the face of the gasket. • The door is hitting an internal component inside the appliance. Adjust interior components to prevent interference.
MOISTURE FORMS ON OUTSIDE OF APPLIANCE	<ul style="list-style-type: none"> • Not unusual during periods of high humidity. Wipe surface dry. • Door left open or package holding door open.
MOISTURE COLLECTS INSIDE	<ul style="list-style-type: none"> • Too frequent or too long door openings. • In humid weather, air carries moisture into appliance when doors are opened.
INTERIOR LIGHT DOES NOT WORK	<ul style="list-style-type: none"> • No power at outlet. • Light bulb needs replacing. See Care and Cleaning. • The Sabbath Mode may be operating. Turn off the Sabbath Mode.
HOT AIR FROM BOTTOM OF APPLIANCE	<ul style="list-style-type: none"> • Normal air flow cooling motor. In the refrigeration process, it is normal that heat be expelled in the area under the appliance. Some floor coverings are sensitive and will discolor at these safe and normal temperatures.
APPLIANCE NEVER SHUTS OFF BUT TEMPERATURES ARE OK	<ul style="list-style-type: none"> • Adaptive defrost keeps compressor running during door openings. This is normal. The appliance will cycle off after the door remains closed for two hours. • Normal operation in extreme temperatures.
ACTUAL TEMPERATURE NOT EQUAL TO SET TEMPERATURE	<ul style="list-style-type: none"> • Unit just plugged in. Allow 24 hours for the system to stabilize. • Door open for too long. Allow 24 hours for the system to stabilize. • Warm contents added to appliance. Allow 24 hours for the system to stabilize. • Defrost cycle is in process. Allow 24 hours for the system to stabilize. • Thermistor may be blocked, which can affect the overall temperature. The thermistor is located on the right hand side just above the top shelf.
TEMPERATURE WILL NOT ADJUST	<ul style="list-style-type: none"> • Temperature may be in lockout mode. Press both + and – pads for 5 seconds to unlock the temperature. • Thermistor may be blocked, which can affect the overall temperature. The thermistor is located on the right hand side just above the top shelf.

NOTES

NOTES

MONOGRAM LIMITED WARRANTY

Monogram.com

All warranty service is provided by our Factory Service Centers, or an authorized Customer Care® technician. To schedule service online, visit us at monogram.com/contact. In Canada, visit monogram.ca.

For the period of	Monogram Appliances will replace
Limited two-year warranty	For two years from date of original purchase, we will provide, free of charge, parts and service labor in your home to repair or replace any part of the unit that fails because of a manufacturing defect.
Limited third through fifth-year warranty	For the third through fifth years from date of original purchase, we will provide, free of charge, parts and service labor in your home to repair or replace any part of the sealed refrigerating system (the compressor, condenser, evaporator and all connecting tubing) that fails because of a manufacturing defect.

What Monogram will not cover:

- Service trips to your home to teach you how to use the product.
 - Replacement of house fuses or resetting of circuit breakers.
 - Damage to the product caused by accident, fire, floods or acts of God.
 - Failure of the product if it is used for other than its intended purpose or used commercially.
 - Damage caused after delivery.
 - Improper installation, delivery or maintenance.
- If you have an installation problem, contact your dealer or installer. You are responsible for providing adequate electrical, plumbing and other connecting facilities.
- Replacement of the light bulbs, if included.
 - Loss of food due to spoilage (in the USA only).
 - Incidental or consequential damage caused by possible defects with this appliance.
 - Product not accessible to provide required service.
 - Damage to finish, such as surface rust, tarnish, or small blemishes not reported within 48 hours of delivery.

EXCLUSION OF IMPLIED WARRANTIES

Your sole and exclusive remedy is product repair as provided in this Limited Warranty. Any implied warranties, including the implied warranties of merchantability or fitness for a particular purpose, are limited to one year or the shortest period allowed by law.

This limited warranty is extended to the original purchaser and any succeeding owner for products purchased for home use within the USA. If the product is located in an area where service by a Monogram Appliances Authorized Servicer is not available, you may be responsible for a trip charge or you may be required to bring the product to an Authorized Monogram Appliances Service location for service. In Alaska, the limited warranty excludes the cost of shipping or service calls to your home.

Some states do not allow the exclusion or limitation of incidental or consequential damages. This limited warranty gives you specific legal rights, and you may also have other rights which vary from state to state. To know what your legal rights are, consult your local or state consumer affairs office or your state's Attorney General.

Warrantor: GE Appliances, a Haier company, Louisville KY,40225

Warrantor in Canada: MC Commercial, Burlington, ON, L7R 5B6

49-1000735
07-23 GEA
Monogram.com
Printed in Serbia

