

BI-30U/S



## FEATURES

LED Lighting for brighter interior

Dual refrigeration keeps food fresher longer

Air purification system fights spoilage, odors

Crispers and deli drawers in low-temp, high-humidity zones for optimum freshness

Microprocessor control assures peak performance

Freshness cards for maximum food preservation

Water-filtration system for ice reduces contaminants, chlorine taste and odor

Rigorously tested in our U.S. manufacturing facilities to ensure decades of use

Exceptional 24/7 support from Madison, WI-based Customer Care team

Over-and-under refrigerator/freezer storage

Magnetic door seal system locks in cold air

Automatic ice maker with "max ice" feature

Adjustable shelves for maximum convenience

## ACCESSORIES

Air Purification Cartridge

Dual Installation Kit

Egg Container

Stainless Steel Kickplate

Stainless Steel Side Panel

Water Filter 4204490

White Side Panel

Side panel mounting kit

Dual Installation Kit with Dual Wide Grille

Built-In Stainless Steel Pro Louvered Grilles

Accessories are available through an authorized dealer.  
For local dealer information, visit [subzero-wolf.com/locator](http://subzero-wolf.com/locator).

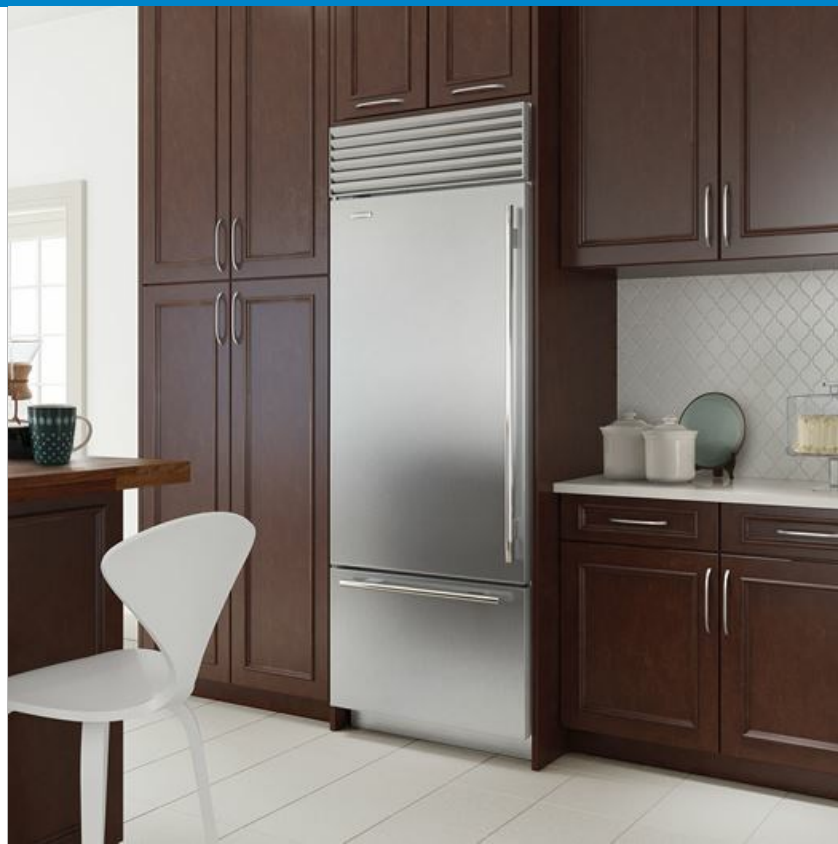

## HANDLE OPTIONS

PRO



TUBULAR



## PRODUCT DETAILS

### REFRIGERATOR

- 3 Adjustable glass shelves
- 1 Stationary glass shelf
- 1 High-humidity drawer with divider
- 1 Storage drawer with divider
- 2 Adjustable door shelves
- 1 Stationary door shelf
- Adjustable dairy compartment

### FREEZER

- Full-extension roll-out freezer drawer
- Two-tier wire storage baskets
- Automatic ice maker

**PRODUCT SPECIFICATIONS**

Model	BI-30U/S
Dimensions	30"W x 84"H x 24"D
Door Clearance	31 1/4"
Drawer Clearance	23 5/8"
Weight	462 lbs
Refrigerator Capacity	13.2 cu. ft.
Freezer Capacity	4.2 cu. ft.
Electrical Supply	115 VAC, 60 Hz
Electrical Service	15 amp dedicated circuit
Receptacle	3-prong grounding-type

**ELECTRICAL**

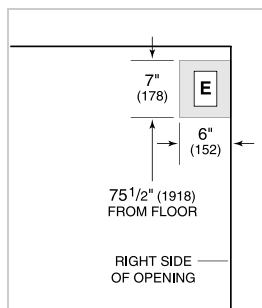

**PLUMBING**

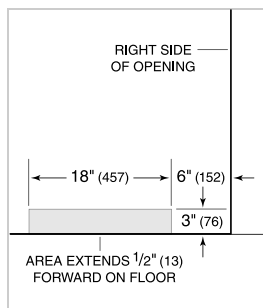

NOTE: Dimensions in parenthesis are in millimeters unless otherwise specified

**INTERIOR VIEW**

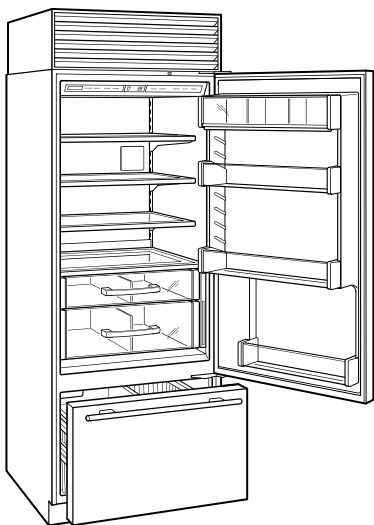

This illustration is intended for interior reference only and may not represent the exterior of the model being specified.

**DIMENSIONS**

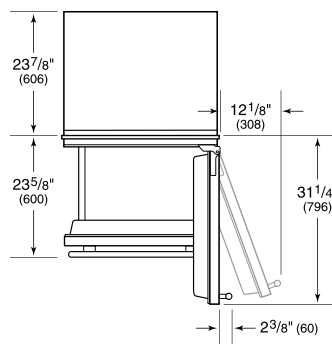
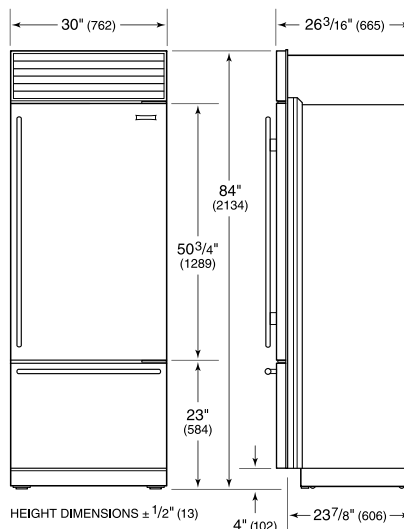

**STANDARD INSTALLATION**

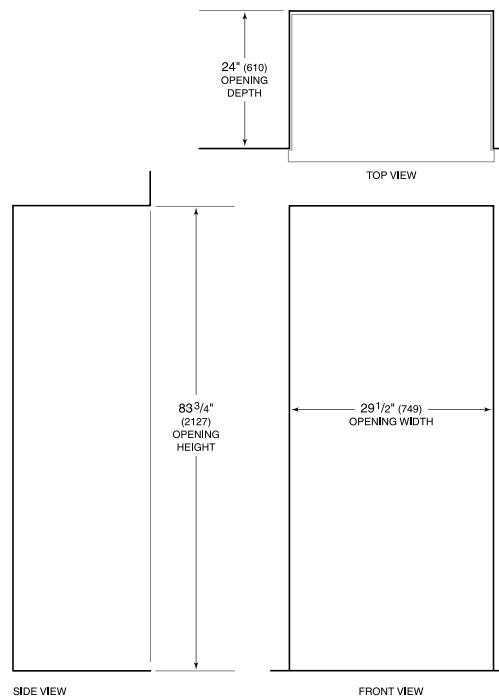

NOTE: Shaded line represents profile of unit.